



**National
Oceanography Centre**

NATURAL ENVIRONMENT RESEARCH COUNCIL

National Oceanography Centre

Cruise Report No. 25

RRS *James Cook* Cruise 090

30 AUG – 17 SEP 2013

Ocean Surface Mixing, Ocean Sub-mesoscale
Interaction Study (OSMOSIS)

Principal Scientist

A Naveira-Garabato

Editor

A Forryan

2013

National Oceanography Centre, Southampton
University of Southampton Waterfront Campus
European Way
Southampton
Hants SO14 3ZH
UK

Tel: +44 (0)23 8059 6429
Email: acng@noc.soton.ac.uk

© National Oceanography Centre, 2013

DOCUMENT DATA SHEET

AUTHOR NAVEIRA-GARABATO, A et al	PUBLICATION DATE 2013
TITLE RRS <i>James Cook</i> Cruise 090, 30 Aug - 17 Sep 2013. Ocean Surface Mixing, Ocean Sub-mesoscale Interaction Study (OSMOSIS)	
REFERENCE Southampton, UK: National Oceanography Centre, Southampton, 111pp. (National Oceanography Centre Cruise Report, No. 25)	
ABSTRACT <p>The RRS <i>James Cook</i> 090 cruise (Vigo, 30 August 2013 - Santander, 17 September 2013) was the concluding phase of the fieldwork for the Ocean Surface Mixing, Ocean Sub-mesoscale Interaction Study (OSMOSIS) consortium. The primary goal of the fieldwork element of OSMOSIS was to obtain a year-long time series of the properties of the ocean surface boundary layer and its controlling 3-d physical processes with an array of moorings (two nested clusters of 4 moorings each centred around a central mooring) and gliders deployed near the Porcupine Abyssal Plain (PAP) observatory, with a view to gaining understanding of and developing parameterizations for those processes. The JC090 cruise sought to recover the moorings and gliders, to conduct hydrographic and biogeochemical measurements for mooring and glider calibration, and to obtain opportunistic measurements of upper-ocean microstructure and air-sea CO₂ fluxes. Operations were very successful. All moorings and gliders were safely recovered, with near-complete data return. Three out of the four guard buoys that had been deployed around the inner mooring cluster were also recovered, with the fourth guard buoy (which had sunk upon deployment) failing to rise to the surface after release. Nearly 700 upper-ocean microstructure profiles were obtained in several transects within the mooring area. 9 CTDs were conducted, and underway measurements of biogeochemical parameters and air-sea CO₂ fluxes obtained throughout much of the cruise. The meteorological buoy at the PAP observatory was also serviced successfully.</p>	
KEYWORDS	
ISSUING ORGANISATION National Oceanography Centre University of Southampton Waterfront Campus European Way Southampton SO14 3ZH UK Tel: +44(0)23 80596116 Email: nol@noc.soton.ac.uk <i>A pdf of this report is available for download at: http://eprints.soton.ac.uk</i>	

Page intentionally left blank

Contents

SCIENTIFIC PERSONNEL	6
SHIP'S PERSONNEL	7
LIST OF FIGURES	8
LIST OF TABLES	10
ABSTRACT	11
1 INTRODUCTION	12
2 NARRATIVE	13
PSO's Diary	13
3 TECHNICAL SUPPORT	16
Mooring Operations	16
Ship Systems Computing	39
CTD Operations	44
Seaglider Recoveries	50
4 SCIENTIFIC INVESTIGATIONS	54
Microstructure Measurements	54
CTD Data Processing and Calibration	65
Oxygen analysis	72
Chlorophyll-a, Inorganic Nutrients, Particulate Organic Carbon/Nitrogen (POC/PON), Scanning Electron Microscope (SEM) filters, Particulate Inorganic Carbon (PIC) and Biogenic Silica (BSi)	75
Lowered Acoustic Doppler Current Profiler (LADCP)	81
Continuous measurements of atmospheric O ₂ and CO ₂	89
Vessel Mounted Acoustic Doppler Current Profiler (VMADCP)	103
Underway Systems	109
Acknowledgements	111

SCIENTIFIC PERSONNEL

NAVEIRA GARABATO, Alberto (Principal Scientist)	Univ. Southampton - SOES
BRANNIGAN, Liam	Univ. Oxford - AOPP
BRIDGER, Martin John	NOC - NMFSS
COMBEN, Daniel Howard	NOC - NMFSS
FORRYAN, Alexander	Univ. Southampton - SOES
GRIFFITHS, Joshua William	Bangor Univ. – SOS
HUTTON, Colin John	NOC - NMFSS
LUCAS, Natasha Sarah	Bangor Univ. – SOS
MACGILCHRIST, Graeme Alastair	Univ. Oxford - AOPP
MANNING, Andrew	UEA
McLACHLAN, Robert Francis	NOC - NMFSS
MARSHALL, David Philip	Univ. Oxford - AOPP
PICKERS, Penelope Anne	UEA
PROVOST, Paul Graham	NOC - NMFSS
WOODWARD, Stephen Colin Ashley	UEA
RUMYANTSEVA, Anna Sergeevna	Univ. Southampton - SOES
TRILL, Emily	Univ. Southampton - SOES
WHITTLE, Stephen Paul	NOC - NMFSS
YOUNGS, Madeine Kendall	CALTECH

NOC - National Oceanography Centre Southampton

NMFSS - NERC Marine Facilities Sea Systems

SOES - School of Ocean and Earth Sciences, University of Southampton

AOPP - Atmosphere, Ocean and Planetary Physics, University of Oxford

SOS - School of Ocean Science, Bangor University

CALTECH - California Institute of Technology

UEA - University of East Anglia

SHIP'S PERSONNEL

SARJEANT, Peter Charles	Master
GRAVES, Malcolm Harold	Chief Officer
MUNRO, Paul Graham	3rd Officer
SMITH, Peter	3rd Officer
PARKINSON, George Grant	Chief Engineer
MURRAY, Michael	2nd Engineer
MURREN, Michael Gerard	3rd Engineer
PORRELLI, Lawrence	3rd Engineer
DAMERELL, Paul Darren	ETO
McDOUGALL, Paula Anne	PCO
LEWIS, Thomas Gregory	CPO(D)
HARRISON, Martin Andrew	CPO(S)
PRICE, David Anthony	PO(D)
HOPLEY, John	SG1A
WELTON, Jarrod David	SG1A
MACKENZIE, David	SG1A
HARKES, David John	SG1A
CONTEH, Brian	ERPO
LYNCH, Peter Anthony	Head Chef
SUTTON, Lloyd Spencer	Chef
ROBINSON, Peter Wayne	Stwd
PIPER, Carl	A/Stwd

List of Figures

1	Diagram showing the layout of the OSMOSIS PAP site mooring array as estimated from the triangulation process on D381.	17
2	Diagram showing the layout of the OSMOSIS PAP site mooring array as estimated from the triangulation process on D381.	33
3	Details of the sensors fitted to the <i>RRS James Cook</i> Met. platform for cruise JC090.	40
4	EM120 angular offsets.	43
5	Steve lowering the deck unit into the water for acoustic interrogation of the Seagliders.	51
6	(Left) 533 being recovered with the rope wrapped around half the rudder and the antenna. (Right) 566 being recovered with the rope wrapped around half the rudder.	52
7	Goose barnacles and algae on Seaglider 566.	53
8	Map of MSS profiling stations over the duration of the cruise showing representative full transects for sessions 1 to 10 and estimated transects for sessions 11 and 12. The black, red and green squares represent the outer, inner and central buoys respectively.	57
9	Significant wave height observed by the ship's radar over the cruise period, noted on alternate MSS profiles.	59
10	Wind speed measured by the ship's meteorological station over the cruise period, noted on alternate MSS profiles.	60
11	Estimate of Bulk Langmuir number ($La^2 = u_*/u_{sob}$) from ship based wind measurements and ship based estimates of significant wave height and period, noted on alternate MSS profiles.	61
12	Turbulent dissipation contour plot for session 10, from 18:40 on the 11 th September 2013 to 14:43 on the 12 th September 2013, from the MSS profiler. Black lines represent the mixed layer depth (<i>de Boyer Montégut, 2004</i>) and the base of the transition layer (<i>Johnston & Rudnick, 2009</i>).	62
13	Salinity contour plot for the session 10, from 18:40 on the 11 th September 2013 to 14:43 on the 12 th September 2013, from the MSS profiler. Black lines represent the mixed layer depth (<i>de Boyer Montégut, 2004</i>) and the base of the transition layer (<i>Johnston & Rudnick, 2009</i>).	62
14	Temperature contour plot for the session 10, from 18:40 on the 11 th September 2013 to 14:43 on the 12 th September 2013, from the MSS profiler. Black lines represent the mixed layer depth (<i>de Boyer Montégut, 2004</i>) and the base of the transition layer (<i>Johnston & Rudnick, 2009</i>).	63
15	Comparison of bottle conductivity to CTD conductivity prior to calibration.	70
16	Comparison of bottle conductivity to CTD conductivity post calibration.	71
17	SBE43 Winkler Oxygen offset.	74
18	Onboard analysis of vertical distribution of total chlorophyll (green line), > 10 um (red line), < 10 um (blue line).	79
19	Time series of underway chlorophyll concentration.	80

20	Spatial distribution of underway chlorophyll concentration (ug/l) (left). Remote sensing image of surface chlorophyll concentration provided by PML 7 day composite 6 – 12 September 2013 (right)	80
21	Photograph of the Lars Maersk container ship, on which we intend to install our atmospheric O ₂ and CO ₂ measurement system.	90
22	Photographs of the aspirated air inlets on the monkey island (left) and the foremast (right).	91
23	Schematic diagram of the atmospheric O ₂ and CO ₂ system, comprising of three units: drying, measurement and calibration.	92
24	Photograph of the drying unit (left rack) and the measurement unit (right rack). Calibration procedures	93
25	Photograph of the cylinder Blue Box, showing three 10L working tank cylinders (top row) and six 20L cylinders used for calibrating the system.	94
26	Screen captures of the Nemo software, showing the schematic tab (top) and the calibration tab (bottom).	96
27	Diagnostic IDL plot from 08 September 2013, showing some of the flow rates and pressures in the gas handling system, as well as the raw analyser output. Such plots are useful for checking the data quality, and for identifying problems in the measurement system.	97
28	Plot of CO ₂ , O ₂ , and APO on 07 September. Pink O ₂ and APO data are those that have been automatically flagged due to erroneous ‘spikes’ in the Oxzilla analyser output. Gaps in the data are periods when the system was being calibrated.	98
29	Plot of CO ₂ , O ₂ , and APO from 08 September, showing an increase in CO ₂ and a simultaneous decrease in O ₂ , but with little change in APO. Black data points are those that have been manually flagged due to a problem in the monkey island sampling line that developed during this period.	99
30	Unflagged 2 minute (blue dots) and hourly (red dots) averages of CO ₂ , O ₂ and APO for the entire period of the cruise.	100
31	Photographs showing damage to one of the diaphragm pumps as indicated by the black residue (left, below the pump rotating shaft) and the suspected cause of the damage, which was trapped water inside the pump head (right).	101
32	U and V velocity estimates from the 75 kHz VMPACP for cruise JC090. White gaps indicate when the data was of too poor a quality to yield a value.	104
33	Comparison of recorded conductivity from underway systems TSG with bottle sample conductivity.	110

List of Tables

1	Instruments recovered on the south-east outer mooring	18
2	Instruments recovered on the north-east outer mooring	19
3	Instruments recovered on the north-east inner mooring	21
4	Instruments recovered on the north-west outer mooring	22
5	Instruments recovered on the north-west inner mooring	24
6	Instruments recovered on the centre mooring	26
7	Instruments recovered on the south-east inner mooring	28
8	Instruments recovered on the south-west outer mooring	29
9	Instruments recovered on the south-west inner mooring	31
10	Guard buoy recovery	32
11	Command file specifications for the 75 kHz ADCPs.	35
12	Command file specifications for the 600 kHz ADCPs	36
13	Nortek Aquadropp specifications	37
14	SBE 37-SM MicroCAT specifications	38
15	Sensors fitted for cruise JC090.	41
16	BODC Ship-fitted Systems Information Sheet (<i>RRS James Cook</i> cruise JC090) Logging status of ship-fitted instrumentation and suites	42
17	Summary of MSS profiler sessions.	56
18	Summary of all CTD casts on cruise JC090.	65
19	Winkler Oxygen sampling schedule	72
20	Winkler Oxygen standard precision	74
21	Samples taken from Niskin bottles	78

ABSTRACT

The *RRS James Cook* 090 cruise (Vigo, 30 August 2013 - Santander, 17 September 2013) was the concluding phase of the fieldwork for the Ocean Surface Mixing, Ocean Sub-mesoscale Interaction Study (OSMOSIS) consortium. The primary goal of the fieldwork element of OSMOSIS was to obtain a year-long time series of the properties of the ocean surface boundary layer and its controlling 3-d physical processes with an array of moorings (two nested clusters of 4 moorings each centred around a central mooring) and gliders deployed near the Porcupine Abyssal Plain (PAP) observatory, with a view to gaining understanding of and developing parameterizations for those processes. The JC090 cruise sought to recover the moorings and gliders, to conduct hydrographic and biogeochemical measurements for mooring and glider calibration, and to obtain opportunistic measurements of upper-ocean microstructure and air-sea CO₂ fluxes. Operations were very successful. All moorings and gliders were safely recovered, with near-complete data return. Three out of the four guard buoys that had been deployed around the inner mooring cluster were also recovered, with the fourth guard buoy (which had sunk upon deployment) failing to rise to the surface after release. Nearly 700 upper-ocean microstructure profiles were obtained in several transects within the mooring area. 9 CTDs were conducted, and underway measurements of biogeochemical parameters and air-sea CO₂ fluxes obtained throughout much of the cruise. The meteorological buoy at the PAP observatory was also serviced successfully.

1 INTRODUCTION

The *RRS James Cook* 090 cruise (Vigo, 30 August 2013 - Santander, 17 September 2013) is the concluding stage of the fieldwork for the Ocean Surface Mixing, Ocean Sub-mesoscale Interaction Study (OSMOSIS) consortium. The primary goal of the fieldwork element of OSMOSIS is to obtain a year-long time series of the properties of the ocean surface boundary layer and its controlling 3-d physical processes with an array of moorings (a ‘submesoscale’ cluster of 5 moorings centred within a ‘mesoscale’ cluster of 4 moorings) and two gliders navigating across the mooring array, deployed near the Porcupine Abyssal Plain observatory. This fieldwork is at the core of the OSMOSIS efforts to gain understanding of and develop parameterizations for the processes determining the evolving stratification and potential vorticity budgets of the ocean surface boundary layer. The JC090 cruise has three goals: 1) to recover the moorings and gliders; 2) to conduct hydrographic and biogeochemical measurements for mooring and glider calibration; and 3) to obtain opportunistic measurements of upper-ocean microstructure and air-sea CO₂ fluxes. Additionally, the meteorological buoy at the PAP observatory is to be serviced, time allowing.

2 NARRATIVE

PSO's Diary

Saturday 31st August We set off from Vigo at approximately 18:00 BST, and sailed northward in fair weather for the rest of the day.

Sunday 1st September We continued sailing northward toward the PAP site, in moderate swell. Gliders were instructed to head for the central mooring cluster, so as to obtain measurements concurrent to those of the moorings for a 2-day period that may be used in glider sensor calibration.

Monday 2nd September We arrived at the PAP site at approximately 15:00 BST. We proceeded to recover the southern guard buoy. As night set in, the CTD cable was streamed to full depth to remove torque in the cable. MSS turbulence profiling was conducted overnight.

Tuesday 3rd September MSS profiling was concluded at around 6:30 BST. The gliders entered the central cluster in the early hours of the day. As daylight arrived, we recovered the eastern and western guard buoys. Mooring operations concluded at around 16:00 BST, and were followed by a CTD to 1000 m (CTD 1) and a CTD to 200 m (CTD 2), primarily for oxygen and chlorophyll sampling. MSS profiling was conducted from approximately 23:00 BST.

Wednesday 4th September MSS profiling was concluded at around 7:00 BST. We then recovered the SE_out mooring. The weather picked up somewhat as we were concluding the recovery, so around 13:00 BST the decision was made to conduct a CTD to 1000 m (CTD 3) while waiting for conditions to improve. At approximately 16:00 BST, we commenced recovery of the NE_out mooring. Not having time to recover the gliders, as we had intended, they were instructed to fly toward the SW_out mooring so as not to interfere with mooring operations the next day. Mooring SE_out was recovered next, and mooring operations concluded after 19:00 BST. We then conducted a 200 m CTD (CTD 4) at a position along the predicted track of the gliders. MSS profiling was conducted from around midnight.

Thursday 5th September MSS profiling was concluded at around 7:30 BST. After some time reorganizing buoyancy on deck, the recovery of mooring NE_in was initiated at 9:30 BST. This was followed by recovery of mooring NW_out, the recovery of which was concluded after 17:00 BST. An unsuccessful attempt to communicate acoustically with the gliders was made in the evening. Following some more re-organisation of gear on deck, the ship steamed to the eastern part of the mooring area and MSS profiling was commenced around 21:00 BST.

Friday 6th September MSS profiling was concluded at around 8:00 BST, after a mid-night break. The recovery of mooring NW_in was commenced at 9:30 BST, and was then followed by recovery of mooring Central, concluded at 17:00 BST. After reorganizing

mooring gear on deck, the ship proceeded to a location close to mooring SW_out, where we conducted a 200 m CTD (CTD 5). MSS profiling was initiated around 9:30 BST.

Saturday 7th September MSS profiling was concluded at around 8:00 BST, after a mid-night break. During the night, the two gliders were instructed to remain at the surface, and were safely recovered between 8:30 and 10:00 BST (SG533 first, then SG566). We initiated recovery of mooring SE.in at mid-day, and followed with recovery of mooring SW_out, finishing at 18:30 BST. We then re-positioned the ship to the location at which we started MSS profiling the previous night, and proceeded with MSS sampling into the night.

Sunday 8th September MSS profiling was concluded after 9:30 BST, as an atmospheric front was passing over us and making the sea state choppy. After a fire drill at mid morning, we recovered the last mooring (SW.in) till mid afternoon. We then triangulated the position of the northern guard buoy, and went on to re-position the ship to the location at which we started MSS profiling the previous two nights. MSS profiling was started near 21:30 BST.

Monday 9th September MSS profiling was concluded at 4:00 BST, in order to allow scientists to adjust to new 4-hours-on / 8-hours-off watches. The northern guard buoy was released at around 10:00 BST, after some discussion on the likely state of the buoy and the convenience of release. The rate of ascent of the buoy was very slow, so in the evening we commenced an MSS transect northeastward from the SW_out mooring position.

Tuesday 10th September Two repeats of a half-diagonal transect along the SW_out – NE_out diagonal were conducted during the night. At approximately 7:00 BST, we steamed to the position of the sunken northern guard buoy and pinged it again. It was found that the guard buoy was still at mid depth, so we decided to abandon it. At approximately 10:30 BST, we commenced a NE_out – SW_out MSS transect.

Wednesday 11th September After completing the NE_out – SW_out MSS transect at approximately 6:00 BST, we steamed to the position of the PAP observatory, and spent much of the day servicing it as requested by Richard Lampitt's group. We then returned to the NE_out position and started a second NE_out – SW_out transect.

Thursday 12th September We concluded the MSS transect at approximately 16:00 BST, and conducted a CTD to 600 m with 20 microcats (CTD 6). We then re-positioned the ship to the NE_out position, and started a third NE_out – SW_out transect.

Friday 13th September At approximately 3:30 BST, an incident occurred during the MSS transect that endangered the instrument. Due to a fault in the ship's engine control system, the MSS profiler was dragged under the ship. Although it was ultimately recovered, the cable was damaged and had to be re-terminated during the day. A CTD to 600 m with 20 microcats (CTD 7) was conducted in the morning. The MSS transect

was resumed at 14:30 BST, and concluded at 21:00 BST. We set off to Santander in fair seas.

Saturday 14th September We stopped our transit at 10:00 BST to conduct a final CTD (CTD 9) to 600 m with microcats. We had intended to trial the new VMP-2000 (to be used in the iSTAR cruise in the Amundsen Sea in January – March 2014) immediately after. However, we experienced various problems putting it together and communicating with it. Although these were eventually resolved, at 18:00 BST the master decided to resume our transit to Santander.

Sunday 15th September We continued to steam toward port in fair seas. At approximately 12:00 BST, we stopped to resume the trial of the new VMP-2000. The instrument appeared to be functional before being deployed, but ceased to communicate upon deployment. It was then found that there was an issue with powering the instrument, and the trial was abandoned. We resumed the steam to Santander at approximately 15:00 BST.

Monday 16th September We continued to make good progress toward Santander, where we arrived at approximately 13:30 BST.

3 TECHNICAL SUPPORT

Mooring Operations – *Liam Brannigan, Paul Provost, Alberto Naveira Garabato*

OSMOSIS Main Array

The mooring operations proceeded according to plan in excellent conditions with almost all instruments recovered. Initial indications are that the instruments were recording for the entire deployment.

The design and objectives of the mooring array are set out in Section 3, a summary of its deployment is given in Section 3, the set-up of the instruments deployed on the moorings is set out in Section 3, while the details of the mooring recovery including which instruments were attached and at what depths are set out in Section 3.

Mooring objectives

The moorings are a key component of the OSMOSIS observational program. The array was structured to allow simultaneous measurement of the mesoscale and submesoscale velocity and density structure with high horizontal and vertical resolution.

Nine instrumented moorings were deployed: four outer moorings at the vertices of a square of approximate length 14 km; a further four inner moorings which formed the vertices of a square of length 2 km; and a centre mooring which was 1.5 km (along the diagonals of the square) from the inner moorings and just under 10 km from the outer moorings. The centre and inner moorings were highly instrumented in order to measure the key submesoscales. The outer moorings were less-instrumented as the objective of these was to observe the larger scale mesoscale flow field. In addition four guard buoys were deployed around the inner moorings in order to warn vessels of activity in the area.

The decision on where to deploy the moorings was based on multi-beam surveys of the PAP site bathymetry conducted during cruises CD158, JC062, and JC071. These showed the PAP site to be largely abyssal plain of depth close to 4830 m with some isolated features rising up to 200 m above the seabed.

Mooring deployment

The mooring deployment occurred in September 2012 during cruise D381 ([link](#)). In summary, the instrumented moorings were all deployed as planned, though the relative locations, as determined by triangulation of the acoustic releases on D381, were slightly distorted from the double square shape (**Figure 1**) due to the vagaries of wind and current. Remote contact with the northern guard buoy (which carried meteorological sensors) was lost shortly after deployment for unknown reasons and it was presumed to have sunk.

Mooring recovery

Mooring recovery operations on JC90 began at 07.05 GMT on 4th September 2013 with the recovery of the SE-O mooring and concluded at 14.35 GMT on 8th September 2013 with the recovery of the SW-I mooring. All moorings were recovered from the aft deck

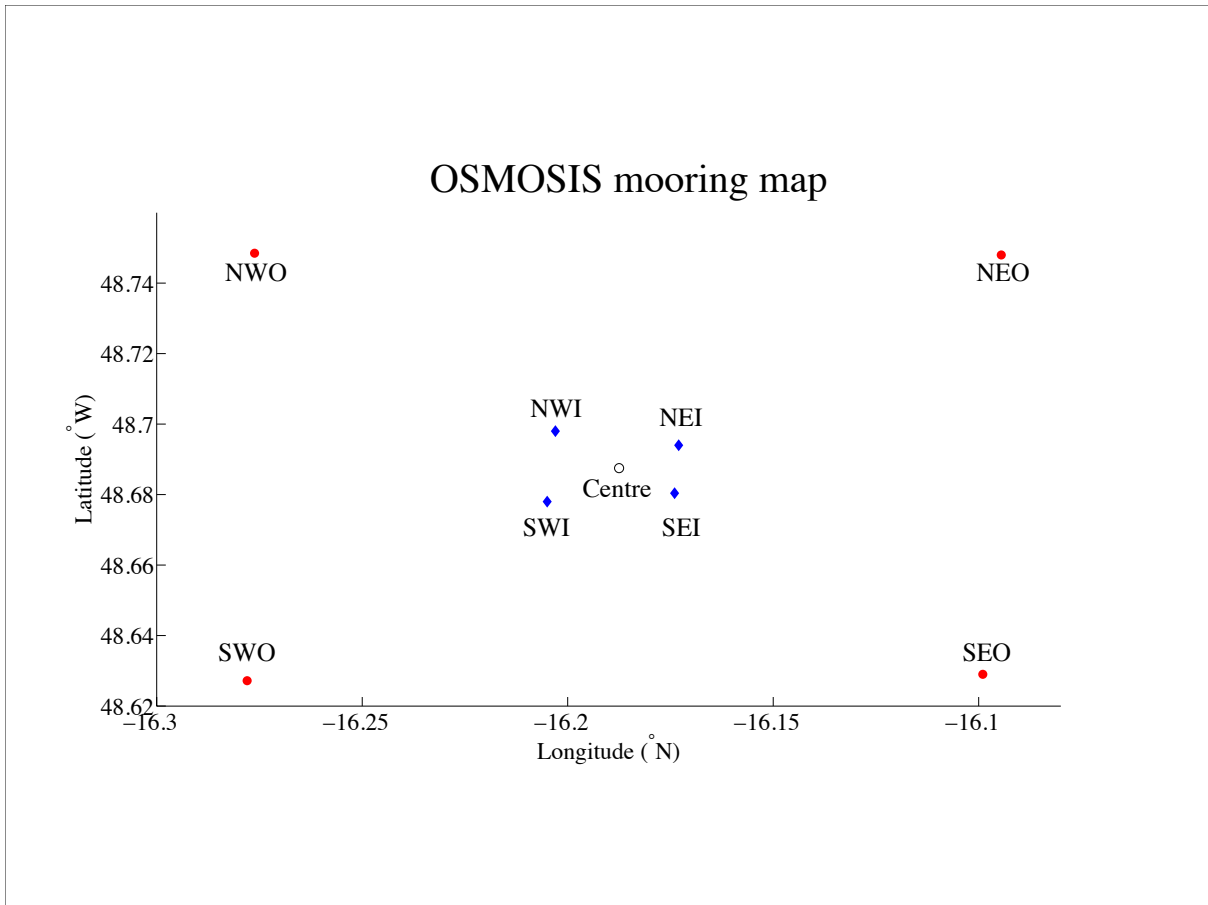

Figure 1: Diagram showing the layout of the OSMOSIS PAP site mooring array as estimated from the triangulation process on D381.

of the *RRS James Cook* by the National Marine Facilities team led by Paul Provost. The guard buoys were recovered first to ensure they would not impede the recovery of the instrumented moorings. The order of the recovery was set by the direction of the current and wind to ensure that any moorings released could not become entangled with moorings still in the water. The moorings were released by the transmission of an acoustic signal to the IXSEA Oceano 2500 releases at depth. There were two releases on each mooring for redundancy and all functioned properly. All moorings were recovered using a NOC double barrel winch (hydraulic) and reeling winch system which was load-tested prior to commencement of operations. For each mooring, the ship was brought into position near the triangulated estimate of the anchor location such that it would be up-current of the moorings upon release. It then manoeuvred alongside once the buoyancy spheres appeared on the surface, whereupon the NMF team and ship’s crew would secure the rope by casting grappling hooks. The moorings were recovered ”top-first, bottom-last” allowing the instruments to be brought on board first. Upon detachment of the instruments from the mooring cable, members of the science party confirmed the serial number and position on the mooring. The instruments were then cleaned and prepared for downloading of the data.

South-east outer mooring

The triangulated position for the south-east outer mooring was 48° 37.74’ N, 16° 5.94’ W in approximately 4,830 m of water. The mooring consisted of five Nortek Aquadropp single-point current meters and five Sea Bird Electronics (SBE) 37 MicroCAT sensors, all of which were recovered. In addition, a light and Argo tag were affixed at the top of the mooring.

Table 1: Instruments recovered on the south-east outer mooring

Instrument and equipment	Serial number	Depth	Notes
Light	J12-028	33 m	
ARGO tag	A02-016	33 m	
Nortek CM	6262	50 m	Potential bio-fouling issue
SBE37 MicroCAT	7305	51 m	Potential bio-fouling issue
Nortek CM	6273	110 m	
SBE37 MicroCAT	7306	110 m	
Nortek CM	6275	224 m	
SBE37 MicroCAT	7307	225 m	
Nortek CM	6276	348 m	
SBE37 MicroCAT	7308	348 m	
Nortek CM	1430	511 m	
SBE37 MicroCAT	7309	512 m	
Release	1135 / 1495	4816 m	

The mooring operation began with the release of the mooring at 07.05 GMT on 4th September 2013 at 48° 38.63’ N, 16° 4.96’ W. The recovery of instruments, buoyancy

devices and releases continued until 10:21 GMT. The uppermost current meter and microCAT had a relatively thick covering of organic material on recovery.

North-east outer mooring

The triangulated position for the north-east outer mooring was 48° 44.88' N, 16° 5.67' W in approximately 4,830 m of water. The mooring consisted of five Nortek Aquadropp single-point current meters and five SBE 37 MicroCAT sensors. In addition, a light and Argo tag were affixed at the top of the mooring. The mooring plan was adjusted for a slightly shallower depth than expected by replacing a 50 m section of cable just above 4810 m depth (on the mooring) with a 20 m section. This gave the mooring a total depth of 4830 m.

Table 2: Instruments recovered on the north-east outer mooring

Instrument and equipment	Serial number	Depth	Notes
Light	B1335	33 m	
ARGO tag	A02-015	33 m	
Nortek CM	6225	50 m	
SBE37 MicroCAT	7298	51 m	
Nortek CM	6242	110 m	
SBE37 MicroCAT	7299	110 m	
Nortek CM	6244	224 m	
SBE37 MicroCAT	7302	225 m	
Nortek CM	6260	348 m	
SBE37 MicroCAT	7303	348 m	
Nortek CM	1420	511 m	
SBE37 MicroCAT	7304	512 m	
Release	1142 / 1272	4816 m	

The mooring operation began with the release of the mooring at 15.33 GMT on 4th September 2013 at 48° 40.05' N, 16° 5.28' W. The recovery of instruments, buoyancy devices and releases continued until 18:44 GMT. Upon recovery two buoyancy spheres were found to have imploded near 1,750 m depth and a further sphere imploded above the release.

North-east Inner mooring

The triangulated position for the north-east inner mooring was 48° 41.64' N, 16° 10.38' W in approximately 4,830 m of water. The mooring consisted of 50 Star-Oddi thermistors, one upward pointing 75 kHz ADCP, three 600 kHz ADCPs, seven Nortek single-point current meters and seven SBE 37 MicroCAT sensors as detailed in **Table 3**. All instruments were recovered. In addition, a light and Argo tag were affixed at the top of the mooring. The mooring plan was adjusted for a slightly shallower depth than expected by replacing a 50 m section of cable just above 4810 m depth (on the mooring) with a 20 m section. This gave the mooring a total depth of 4830 m.

Instrument and equipment	Serial number	Depth	Notes
Thermistor	T4242	35 m	
Light	W06-007	35 m	
ARGO tag	A02-020	35 m	
Thermistor	T4244	46 m	
600 kHz ADCP	WHS3644	51 m	
Thermistor	T4245	52 m	
Nortek CM	9853	54 m	
SBE37 MicroCAT	9381	54 m	
Thermistor	T4246	59 m	Not checked in sequence
Thermistor	T4247	64 m	Not checked in sequence
Thermistor	T4248	69 m	Not checked in sequence
Thermistor	T4249	74 m	Not checked in sequence
Thermistor	T4251	79 m	
Thermistor	T4252	84 m	
Thermistor	T4253	89 m	
Thermistor	T4254	94 m	
Thermistor	T4255	99 m	
600 kHz ADCP	WHS3821	108 m	
Thermistor	T4256	110 m	
Nortek CM	9854	111 m	
SBE37 MicroCAT	9382	112 m	
Thermistor	T4467	117 m	
Thermistor	T4258	122 m	
Thermistor	T4259	127 m	
Thermistor	T4260	132 m	
Thermistor	T4261	137 m	
Thermistor	T4262	142 m	
Thermistor	T4263	147 m	
Thermistor	T4264	152 m	
Nortek CM	9859	160 m	
SBE37 MicroCAT	9383	160 m	
Thermistor	T4265	163 m	
Thermistor	T4266	172 m	
Thermistor	T4267	181 m	
Thermistor	T4268	190 m	
Thermistor	T4404	199 m	
Thermistor	T4405	208 m	
Thermistor	T4406	217 m	
600 kHz ADCP	WHS4015	228 m	
Thermistor	T4407	229 m	
Nortek CM	9861	230 m	
SBE37 MicroCAT	9384	231 m	
Thermistor	T4408	236 m	
Thermistor	T4411	246 m	

Continued on next page

Table 3 – *continued from previous page*

Instrument and equipment	Serial number	Depth	Notes
Thermistor	T4412	256 m	
Thermistor	T4413	266 m	
Thermistor	T4414	276 m	
Thermistor	T4415	286 m	
Thermistor	T4416	295 m	
Nortek CM	9867	299 m	
SBE37 MicroCAT	9385	299 m	
Thermistor	T4418	305 m	
Thermistor	T4419	319 m	
Thermistor	T4420	334 m	
Thermistor	T4421	348 m	
Nortek CM	9868	352 m	Serial number not visible
SBE37 MicroCAT	7316	353 m	
Thermistor	T4422	363 m	
Thermistor	T4423	378 m	
Thermistor	T4424	393 m	
Thermistor	T4425	408 m	
Thermistor	T4426	423 m	
Thermistor	T4427	438 m	
75 kHz ADCP	LR17825	452 m	
Thermistor	T4428	453 m	
Thermistor	T4429	464 m	
Thermistor	T4430	479 m	
Thermistor	T4432	494 m	
Nortek CM	9874	512 m	
SBE37 MicroCAT	8075	513 m	
Release	1138 / 1494	4816 m	

Table 3: Instruments recovered on the north-east inner mooring

The mooring operation began with the release of the mooring at 08.53 GMT on 5th September 2013 at 48° 42.91' N, 16° 9.71' W. The recovery of instruments, buoyancy devices and releases continued until 12:27 GMT. In a departure from the original plan, the 600 kHz ADCPs were deployed looking upwards to minimise interference from the other instruments. The thermistors between 59 - 74 m were all recovered, but not checked to ensure they were in the correct sequence. The serial number of the Nortek at 352 m was not visible. Its inventory number was noted as 250007426.

North-west outer mooring

The triangulated position for the north-west outer mooring was 48° 44.91' N, 16° 16.57' W in approximately 4,830 m of water. The mooring consisted of five Nortek Aquadropp single-point current meters and five SBE 37 MicroCAT sensors. In addition, a light and

Argo tag were affixed at the top of the mooring. All instruments were recovered. The mooring plan was adjusted for a slightly shallower depth than expected by replacing a 50 m section of cable just above 4810 m depth (on the mooring) with a 20 m section. This gave the mooring a total depth of 4830 m.

Table 4: Instruments recovered on the north-west outer mooring

Instrument and equipment	Serial number	Depth	Notes
Light	A1554	33 m	
ARGO tag	A02-014	33 m	
Nortek CM	6203	50 m	
SBE37 MicroCAT	7293	51 m	
Nortek CM	6212	110 m	
SBE37 MicroCAT	7294	111 m	
Nortek CM	6213	224 m	
SBE37 MicroCAT	7295	225 m	
Nortek CM	6224	348 m	
SBE37 MicroCAT	7296	349 m	
Nortek CM	1415	511 m	
SBE37 MicroCAT	7297	512 m	
Release	831 / 1270	4816 m	

The mooring operation began with the release of the mooring at 13:38 GMT on 5th September 2013 at 48° 45.10' N, 16° 9.71' W. The recovery of instruments, buoyancy devices and releases continued until 16:12 GMT. Three buoyancy spheres were found to have imploded above the release.

North-west inner mooring

The triangulated position for the inner north-west mooring was 48° 41.88' N, 16° 12.18' W in approximately 4,830 m of water. The mooring consisted of 50 Star-Oddi thermistors, one upward pointing 75 kHz ADCP, seven Nortek single-point current meters and seven SBE 37 MicroCAT sensors as detailed in **Table 3**. In addition, a light and Argo tag were affixed at the top of the mooring. All instruments were recovered. The mooring plan was adjusted with the 200 m section below 4154 m replaced by two 100 m sections and also for a slightly shallower depth by replacing a 50 m section of cable just above 4810 m depth (on the mooring) with a 20 m section. This gave the mooring a total depth of 4830 m.

Instrument and equipment	Serial number	Depth	Notes
Thermistor	T4215	33 m	
Light	W06-005	33 m	
ARGO tag	A02-018	33 m	
Thermistor	T4216	47 m	

Continued on next page

Table 5 – *continued from previous page*

Instrument and equipment	Serial number	Depth	Notes
Nortek CM	8352	53 m	
Thermistor	T4217	53 m	
SBE37 MicroCAT	9376	54 m	
Thermistor	T4220	59 m	
Thermistor	T4221	64 m	
Thermistor	T4222	69 m	
Thermistor	T4223	74 m	
Thermistor	T4224	79 m	
Thermistor	T4225	84 m	
Thermistor	T4226	89 m	
Thermistor	T4227	94 m	
Thermistor	T4228	99 m	
Nortek CM	8355	110 m	
Thermistor	T4229	110 m	
SBE37 MicroCAT	9377	111 m	
Thermistor	T4230	115 m	
Thermistor	T4231	120 m	
Thermistor	T4232	125 m	
Thermistor	T4233	130 m	
Thermistor	T4234	135 m	
Thermistor	T4235	140 m	
Thermistor	T4236	145 m	
Thermistor	T4237	150 m	
Nortek CM	8360	159 m	
SBE37 MicroCAT	9378	160 m	
Thermistor	T4238	162 m	
Thermistor	T4239	171 m	
Thermistor	T4240	180 m	
Thermistor	T4241	189 m	
Thermistor	T4369	198 m	
Thermistor	T4371	207 m	
Thermistor	T4372	216 m	
Nortek CM	8362	228 m	
Thermistor	T4382	228 m	
SBE37 MicroCAT	9379	229 m	
Thermistor	T4383	234 m	
Thermistor	T4384	244 m	
Thermistor	T4385	254 m	
Thermistor	T4386	264 m	
Thermistor	T4387	274 m	
Thermistor	T4388	284 m	
Thermistor	T4389	293 m	
Nortek CM	8364	298 m	

Continued on next page

Table 5 – *continued from previous page*

Instrument and equipment	Serial number	Depth	Notes
SBE37 MicroCAT	9380	299 m	
Thermistor	T4390	305 m	
Thermistor	T4391	319 m	
Thermistor	T4392	334 m	
Thermistor	T4393	348 m	
Nortek CM	8365	352 m	
SBE37 MicroCAT	7312	353 m	
Thermistor	T4394	363 m	
Thermistor	T4395	378 m	
Thermistor	T4396	393 m	
Thermistor	T4397	408 m	
Thermistor	T4398	423 m	
Thermistor	T4399	438 m	
75 kHz ADCP	LR10584	452 m	
Thermistor	T4400	453 m	
Thermistor	T4401	465 m	
Thermistor	T4402	480 m	
Thermistor	T4403	495 m	
Nortek CM	9822	513 m	
SBE37 MicroCAT	7313	514 m	
Release	1136 / 1492	4816 m	

Table 5: Instruments recovered on the north-west inner mooring

The mooring operation began with the release of the mooring at 07.57 GMT on 5th September 2013 at 48° 41.51' N, 16° 12.41' W. The recovery of instruments, buoyancy devices and releases continued until 10:56 GMT. The surface pellet buoy was lost on recovery and there was a long ($O(100\text{ m})$) tangle in the lower part of the cable, which is thought to have occurred on recovery.

Centre mooring

The triangulated position for the centre mooring was 48° 41.25' N, 16° 11.25' W in approximately 4,830 m of water. The mooring consisted of 48 Star-Oddi thermistors, one upward pointing 75 kHz ADCP, four 600 kHz ADCPs, thirteen Nortek single-point current meters and thirteen SBE 37 MicroCAT sensors as detailed in **Table 3**. In addition, a light and Argo tag were affixed at the top of the mooring. All instruments were recovered. The mooring plan was adjusted for a slightly shallower depth than expected by replacing a 60 m section of cable just above 4810 m depth (on the mooring) with a 30 m section. This gave the mooring a total depth of 4820 m.

Instrument and equipment	Serial number	Depth	Notes	
Thermistor	T2607	33 m	No label	
Light	W10-030	33 m		
ARGO tag	A02-021	33 m		
Thermistor	T2608	47 m		
600 kHz ADCP	WHS2390	48 m		
Thermistor	T2618	50 m		
Nortek CM	9956	53 m		
SBE37 MicroCAT	9391	54 m		
Thermistor	T2620	57 m		
Thermistor	T2622	62 m		
Thermistor	T2624	67 m		
Thermistor	T2846	72 m		Serial number change
600 kHz ADCP	WHS7301	76 m		
Thermistor	T2850	77 m		
Nortek CM	9957	79 m		
SBE37 MicroCAT	9392	79 m		
Thermistor	T3114	84 m		
Thermistor	T3725	89 m		
Thermistor	T3727	94 m		
Thermistor	T3728	99 m		
Thermistor	T3729	104 m		
Nortek CM	9960	112 m		
Thermistor	T3730	113 m		
SBE37 MicroCAT	9393	113 m		
Thermistor	T3731	118 m		
Thermistor	T3732	123 m		
Thermistor	T4294	128 m		
Thermistor	T4295	133 m		
Thermistor	T4296	138 m		
Nortek CM	9962	145 m		
Thermistor	T4297	145 m		
SBE37 MicroCAT	9394	146 m		
Thermistor	T4298	151 m		
Thermistor	T4299	156 m		
600 kHz ADCP	WHS5807	158 m		
Nortek CM	9966	161 m		
SBE37 MicroCAT	9395	162 m		
Thermistor	T4300	170 m		
Thermistor	T4301	178 m		
Thermistor	T4302	186 m		
Nortek CM	9968	195 m		
Thermistor	T4303	195 m		
SBE37 MicroCAT	9396	195 m		
Thermistor	T4461	203 m		

Continued on next page

Table 6 – *continued from previous page*

Instrument and equipment	Serial number	Depth	Notes
Thermistor	T4462	211 m	
Thermistor	T4463	219 m	
Nortek CM	9969	228 m	
Thermistor	T4464	228 m	
SBE37 MicroCAT	9397	229 m	
Thermistor	T4465	239 m	
Thermistor	T4466	249 m	
Nortek CM	9972	261 m	
SBE37 MicroCAT	9398	262 m	
Thermistor	T4468	272 m	
Thermistor	T4469	282 m	
600 kHz ADCP	WHS3725	294 m	
Thermistor	T4470	294 m	
Nortek CM	9975	297 m	
SBE37 MicroCAT	9399	297 m	
Thermistor	T4471	303 m	
Thermistor	T4472	317 m	
Thermistor	T4473	332 m	
Thermistor	T4474	346 m	
Nortek CM	9976	350 m	
SBE37 MicroCAT	8076	351 m	
Thermistor	T4475	357 m	
Thermistor	T4476	371 m	
Thermistor	T4477	386 m	
Nortek CM	9979	402 m	
SBE37 MicroCAT	8077	402 m	
Thermistor	T4479	418 m	
Thermistor	T4480	434 m	
Thermistor	T4481	448 m	
75 kHz ADCP	LR5575	454 m	
Nortek CM	9986	458 m	
SBE37 MicroCAT	8078	459 m	
Thermistor	T4482	464 m	
Thermistor	T4483	479 m	
Thermistor	T4484	494 m	
Nortek CM	9989	512 m	
SBE37 MicroCAT	8079	512 m	
Release	1137 / 1493	4816 m	

Table 6: Instruments recovered on the centre mooring

The mooring operation began with the release of the mooring at 11.57 GMT on 6th September 2013 at 48° 40.97' N, 16° 11.24' W. The recovery of instruments, buoyancy

devices and releases continued until 15:19 GMT. The thermistor at 72 m depth had serial number T2846, rather than T2864 (i.e. with the last two digits exchanged) as listed on the original plan. This was also noted in the cruise report for D381. The thermistor at 47 m depth was recovered with no label, but had its sequence position marked in pen.

South-east Inner mooring

The triangulated position for the inner south-east mooring was 48° 40.82' N, 16° 10.440' W in approximately 4,830 m of water. The mooring consisted of 48 Star-Oddi thermistors, one upward pointing 75 kHz ADCP, seven Nortek single-point current meters and seven SBE 37 MicroCAT sensors. In addition, a light and Argo tag were affixed at the top of the mooring. All instruments were recovered. The mooring plan was adjusted for a slightly shallower depth than expected by replacing a 50 m section of cable just above 4810 m depth (on the mooring) with a 20 m section. This gave the mooring a total depth of 4830 m.

Instrument and equipment	Serial number	Depth	Notes
Thermistor	T4269	33 m	
Light	W06-006	33 m	
ARGO tag	A02-019	33 m	
Thermistor	T4270	47 m	
Nortek CM	9877	53 m	
Thermistor	T4271	53 m	
SBE37 MicroCAT	9386	54 m	
Thermistor	T4272	59 m	
Thermistor	T4273	64 m	
Thermistor	T4274	69 m	
Thermistor	T4275	74 m	
Thermistor	T4276	79 m	
Thermistor	T4277	84 m	
Thermistor	T4278	89 m	
Thermistor	T4279	94 m	
Thermistor	T4280	99 m	
Nortek CM	9881	110 m	
Thermistor	T4281	110 m	
SBE37 MicroCAT	9387	111 m	
Thermistor	T4282	115 m	
Thermistor	T4283	120 m	
Thermistor	T4284	125 m	
Thermistor	T4285	130 m	
Thermistor	T4286	135 m	
Thermistor	T4287	140 m	
Thermistor	T4288	145 m	
Thermistor	T4289	150 m	
Nortek CM	9885	159 m	Growth on instrument

Continued on next page

Table 7 – *continued from previous page*

Instrument and equipment	Serial number	Depth	Notes
SBE37 MicroCAT	9388	160 m	Growth on instrument
Thermistor	T4290	162 m	
Thermistor	T4291	171 m	
Thermistor	T4292	180 m	
Thermistor	T4293	189 m	
Thermistor	T4433	198 m	
Thermistor	T4434	207 m	
Thermistor	T4437	216 m	
Nortek CM	9905	228 m	
Thermistor	T4439	228 m	
SBE37 MicroCAT	9389	229 m	
Thermistor	T4440	234 m	
Thermistor	T4441	244 m	
Thermistor	T4442	254 m	
Thermistor	T4443	264 m	
Thermistor	T4444	274 m	
Thermistor	T4445	284 m	
Thermistor	T4446	293 m	
Nortek CM	9909	298 m	
SBE37 MicroCAT	9390	299 m	
Thermistor	T4447	305 m	
Thermistor	T4448	319 m	
Thermistor	T4478	334 m	
Thermistor	T4450	348 m	
Nortek CM	9912	352 m	
SBE37 MicroCAT	7314	353 m	
Thermistor	T4451	363 m	
Thermistor	T4452	378 m	
Thermistor	T4453	393 m	
Thermistor	T4454	408 m	
Thermistor	T4455	423 m	
Thermistor	T4456	438 m	
75 kHz ADCP	LR17826	452 m	
Thermistor	T4457	453 m	
Thermistor	T4458	465 m	
Thermistor	T4459	480 m	
Thermistor	T4460	495 m	
Nortek CM	9926	513 m	
SBE37 MicroCAT	7315	514 m	
Release	1140 / 1497	4816 m	

Table 7: Instruments recovered on the south-east inner mooring

The mooring operation began with the release of the mooring at 10.32 GMT on 7th September 2013 at 48° 40.56' N, 16° 09.52' W. The recovery of instruments, buoyancy devices and releases continued until 14:36 GMT. The surface pellet buoy was lost as the topmost part of the mooring split on recovery. The current meter and microCAT near 160 m depth had a marine growth on their exterior.

South-west outer mooring

The triangulated position for the outer south-west mooring was 48° 37.800' N, 16° 16.800' W in approximately 4,830 m of water. The mooring consisted of five Nortek single-point current meters and five SBE 37 MicroCAT sensors as detailed in **Table 8**. In addition, a light and Argo tag were affixed at the top of the mooring. All instruments were recovered. The mooring plan was adjusted for a slightly shallower depth than expected by replacing a 50 m section of cable just above 4810 m depth (on the mooring) with a 20 m section. A summary of the instruments deployed along with the time they went in the water as part of the streaming operation and their target depth below the surface is set out in **Table 8**.

Instrument and equipment	Serial number	Depth	Notes
Light	18664	33 m	
ARGO tag	A02-013	33 m	
Nortek CM	5883	50 m	
SBE37 MicroCAT	7288	51 m	
Nortek CM	6178	110 m	
SBE37 MicroCAT	7289	111 m	
Nortek CM	6181	224 m	
SBE37 MicroCAT	7290	225 m	
Nortek CM	6182	348 m	
SBE37 MicroCAT	7291	349 m	
Nortek CM	1404	511 m	
SBE37 MicroCAT	7292	512 m	
Release	1469 / 1496	4816 m	

Table 8: Instruments recovered on the south-west outer mooring

The mooring operation began with the release of the mooring at 15.33 GMT on 4th September 2013 at 48° 38.63' N, 16° 4.96' W. The recovery of instruments, buoyancy devices and releases continued until 10:21 GMT.

South-west inner mooring

The triangulated position for the south-west mooring was 48° 40.740' N, 16° 12.360' W in approximately 4,830 m of water. The mooring consisted of 50 Star-Oddi thermistors, one upward pointing 75 kHz ADCP, seven Nortek single-point current meters and seven SBE 37 MicroCAT sensors as detailed in **Table 3**. In addition, a light and Argo tag were affixed at the top of the mooring. All instruments were recovered with the exception of

the thermistor at 47 m depth. The mooring plan was adjusted for a slightly shallower depth than expected by replacing a 50 m section of cable just above 4810 m depth (on the mooring) with a 20 m section. This gave the mooring a total depth of 4830 m.

Instrument and equipment	Serial number	Depth	Notes	
Thermistor	T4185	33 m	NOT RECOVERED	
Light	W03-095	33 m		
ARGO tag	A02-017	33 m		
Thermistor	T4186	47 m		
Nortek CM	8059	53 m		
Thermistor	T4192	53 m		
SBE37 MicroCAT	9371	54 m		
Thermistor	T4193	59 m		
Thermistor	T4194	64 m		
Thermistor	T4195	69 m		
Thermistor	T4196	74 m		
Thermistor	T4197	79 m		
Thermistor	T4198	84 m		
Thermistor	T4199	89 m		
Thermistor	T4200	94 m		Label ripped
Thermistor	T4201	99 m		
Nortek CM	8080	110 m		Label ripped
Thermistor	T4202	110 m		
SBE37 MicroCAT	9372	111 m		
Thermistor	T4203	115 m		
Thermistor	T4204	120 m		
Thermistor	T4205	125 m		
Thermistor	T4206	130 m		
Thermistor	T4207	135 m		
Thermistor	T4208	140 m		
Thermistor	T4209	145 m		
Thermistor	T4210	150 m		
Nortek CM	8088	159 m		
SBE37 MicroCAT	9373	160 m		
Thermistor	T4211	162 m		
Thermistor	T4212	171 m		
Thermistor	T4213	180 m		
Thermistor	T4214	189 m		
Thermistor	T4343	198 m		
Thermistor	T4344	207 m		
Thermistor	T4345	216 m		
Nortek CM	8093	228 m		
Thermistor	T4346	228 m		
SBE37 MicroCAT	9374	229 m		
Thermistor	T4347	234 m		

Continued on next page

Table 9 – *continued from previous page*

Instrument and equipment	Serial number	Depth	Notes
Thermistor	T4348	244 m	
Thermistor	T4349	254 m	
Thermistor	T4350	264 m	
Thermistor	T4351	274 m	
Thermistor	T4352	284 m	
Thermistor	T4353	293 m	
Nortek CM	8097	298 m	
SBE37 MicroCAT	9375	299 m	
Thermistor	T4354	305 m	
Thermistor	T4355	319 m	
Thermistor	T4356	334 m	
Thermistor	T4357	348 m	
Nortek CM	8111	352 m	
SBE37 MicroCAT	7310	353 m	
Thermistor	T4359	363 m	
Thermistor	T4360	378 m	
Thermistor	T4361	393 m	
Thermistor	T4362	408 m	
Thermistor	T4363	423 m	
Thermistor	T4364	438 m	
75 kHz ADCP	LR10583	452 m	
Thermistor	T4365	453 m	
Thermistor	T4366	465 m	
Thermistor	T4367	480 m	
Thermistor	T4368	495 m	
Nortek CM	8351	513 m	
SBE37 MicroCAT	7311	514 m	
Release	1134 / 1491	4816 m	

Table 9: Instruments recovered on the south-west inner mooring

The mooring operation began with the release of the mooring at 11.38 GMT on 8th September 2013 at 48° 40.31' N, 16° 11.57' W. The recovery of instruments, buoyancy devices and releases continued until 14:35 GMT. There was a long tangle on the cable at depth, which is thought to have developed on release of the mooring.

Guard buoys

The presence of the southern, western and eastern guard buoys at the surface was confirmed by the ship's radar upon arrival at the PAP site on 1st September. The three guard buoys were all at the north-eastern edge of their range due to the prevailing wind and currents. These were then recovered with all their rope, buoyancy and releases over the following two days, as detailed in Table 3. An unexpected element of the guard buoy

recovery was the presence on their sides of vigorous populations of goose barnacles more typically associated with coastal locations, particularly on the southern buoy. However, these did not appear to affect the functioning of the guard buoys in any way.

Table 10: Guard buoy recovery

Position	Latitude	Longitude	Time Onboard (GMT)
Eastern	48°42.45' N	16° 6.36' W	07:31 02/09/2013
Southern	48° 39.70' N	16° 9.85' W	13:53 02/09/2013
Western	48°42.07' N	16° 13.19' W	11:49 03/09/2013

Following the recovery of the instrumented moorings an effort was made to locate and recover the northern guard buoy given that its acoustic release was still communicating. On 9th September 2013 the location of the acoustic release was estimated by triangulation to 48° 43.6' N, 16° 11.5' W. The release was then triggered at 10.18 and the depth of the release was estimated based on the slant distance given by the instrument and the horizontal distance given by the triangulation. The estimated depth of the release shallowed, however at a very slow rate of 7 metres per minute on average such that by 14.45 the estimated depth of the release was 2890 m before eventually reaching a shallowest depth of 2150 m. We think that this is because the surface buoy sunk and remained on the sea bed where the cable would have become tangles, preventing the release from rising further, as shown schematically in Figure 2.

OSMOSIS Guard Buoy (Met Office)
to recover DY006
Water depth: 4850m



Estimated A/R Position
@ 2150m depth (range = 2700m)
48 45.00' N
16 09.00' W

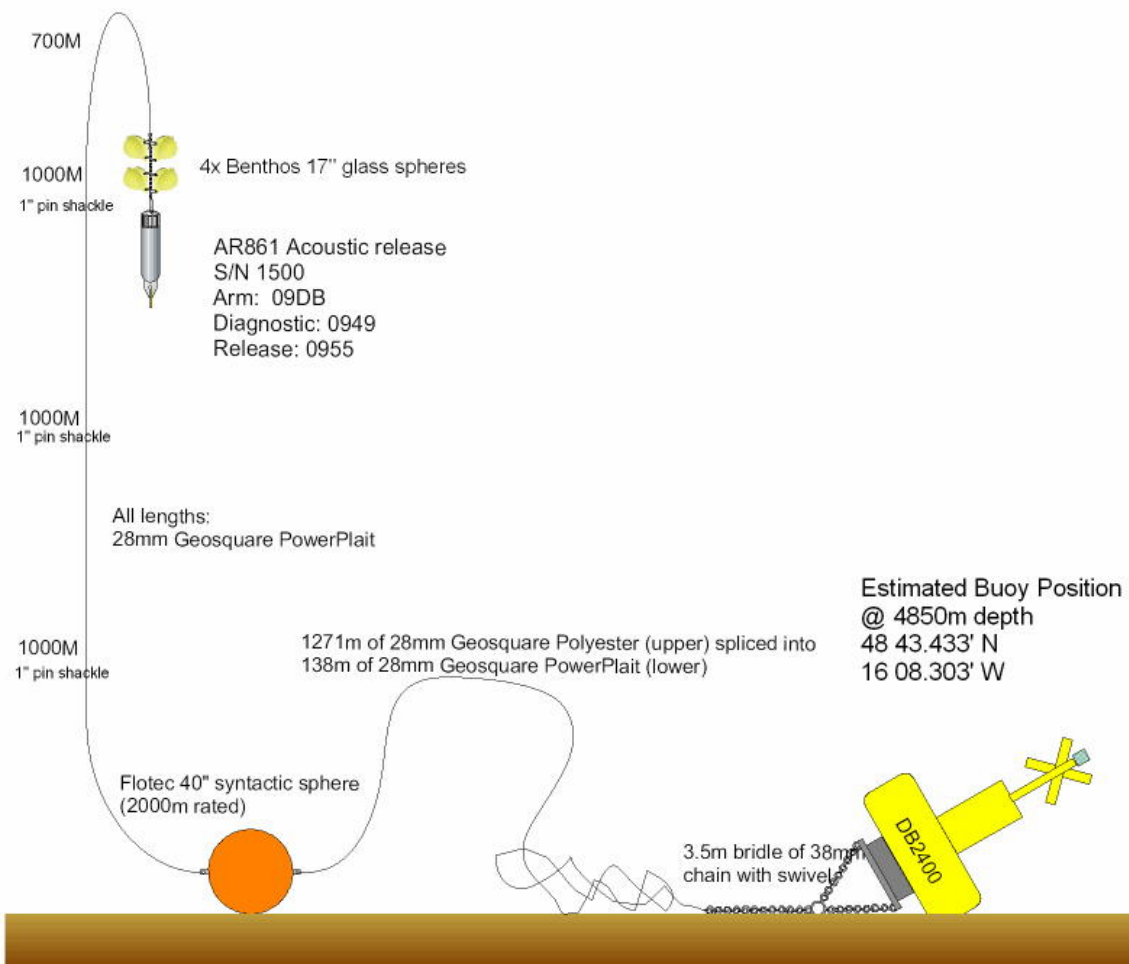

Figure 2: Diagram showing the layout of the OSMOSIS PAP site mooring array as estimated from the triangulation process on D381.

Instrumentation

75 kHz ADCP

The inner and centre moorings were deployed with 75 kHz RDI Long Ranger ADCP units¹. The objective for these units was to measure the upper ocean horizontal velocity structure across a range of depths. As such they were deployed close to 450 m depth on the moorings pointing upwards. This allowed them to measure velocities accurately until surface wave interference became too large. In **Table 11** below, the command file for these units is set out along with an explanation of what the setting implies.

Instrument	Workhorse Long Ranger
Beam angle	20°
Frequency	76.8 Khz
First cell range	16.62 m
Last cell range	568.62 m
Noise level	2.34 cm s ⁻¹
CB411	The unit transmits data at a rate of 9600 baud; there is no parity; and the stop bit is 1 bit.
CR1	Restore the unit to factory settings before entering parameters below.
CQ255	Transmit power is set to highest value.
CF11101	The flow control unit: automatically starts new ensemble and ping cycles; provides data in binary format; has serial output disabled; and records the data.
WM1	The ADCP is set up for a dynamic sea state.
EA0	The ADCP heading alignment is uncorrected (i.e. beam 3 is the heading reference).
EB0	No correction to heading due to electrical or magnetic bias.
ED4500	The ADCP transducer depth is 4500 decimetres (used for speed of sound calculation).
ES35	The salinity is estimated at 35 ppt (used for speed of sound calculation).
ET+0700	The water temperature is taken as 7° C (used for speed of sound calculation).
EX00000	No coordinate transformation is applied; tilt is not used in transformation; no three-beam solutions if one beam falls below the correlation threshold; no bin-mapping.
EZ1111101	Calculate speed of sound from readings; use pressure sensor, transducer heading, internal tilt sensors and transducer temperature.
WA050	False target threshold maximum - this sets the maximum echo intensity difference between beams. If this value is exceeded (normally due to passing fish) the velocity data is rejected.

¹We follow oceanographic convention in rounding off the frequency when discussing the ADCPs - the exact operating frequency is listed in **Table 11**.

WB1	Mode 1 bandwidth set to narrow-band to allow a low sampling rate and high profiling range.
WD111100000	The ADCP collects velocity, correlation, echo intensity and percent good data.
WF704	Blank after transmit set such that the first cell begins 7.04 m away from the transducer.
WN70	Data collected over 70 depth cells.
WP39	Each ensemble averages over 39 pings.
WS800	Each depth cell is 8 m thick.
WV175	The radial ambiguity velocity is set to 175 cm s ⁻¹ .
TE01:00:00.00	The 39 pings are averaged over 1 hour.
TP01:30.00	The minimum time between pings is set to 1 minute 30 seconds.
TF12/08/28, 12:00:00	The first ping was set to occur at noon on 28th August 2012.
CK	Store the parameters set out above in non-volatile memory.
CS	Start pinging.

Table 11: Command file specifications for the 75 kHz ADCPs.

600 kHz ADCPs

The centre and north-east inner moorings were deployed with 600 kHz RDI Sentinel ADCP units. The objective for these units is to measure the small length scale (1 m) velocity field and use a structure function method to calculate the dissipation of turbulent kinetic energy. In **Table 3** below, the command file for these units is set out along with an explanation of what the setting implies. In a departure from the original mooring plan, the 600 kHz ADCPs were deployed pointing upwards to minimise interference from other instruments.

Instrument	Workhorse Sentinel
Beam angle	20°
Frequency	614.4 Khz
First cell range	0.97 m
Last cell range	3.47 m
Noise level	0.61 cm s ⁻¹
CB411	The unit transmits data at a rate of 9600 baud; there is no parity; and the stop bit is 1 bit
CR1	Restore the unit to factory settings before entering parameters below
CF11101	The flow control unit: automatically starts new ensemble and ping cycles, provides data in binary format, has serial output disabled and records the data
EA0	The ADCP heading alignment is uncorrected (i.e. beam 3 is the heading reference)

EB0	No correction for heading bias due to electrical or magnetic bias
ED2000	The ADCP transducer depth is 2000 decimetres (used for speed of sound calculation)
ES35	The salinity is estimated at 35 ppt for the speed of sound calculation
EX00000	No coordinate transformation is applied; tilt is not used in transformation; no three-beam solutions if one beam falls below the correlation threshold; no bin-mapping
EZ1111101	Calculate speed of sound from readings, use pressure sensor, transducer heading, internal tilt sensors and transducer temperature
WA50	False target threshold maximum - this sets the maximum echo intensity difference between beams. If this value is exceeded (normally due to passing fish) the velocity data is rejected
WB0	Mode 1 Bandwidth set to wide-band to allow a high sampling rate, low data variance and low profiling range
WD111100000	The ADCP collects velocity, correlation, echo intensity and percent good data
WF88	Blank after transmit set such that the first cell begins 0.88 m away from the transducer
WM5	ADCP is set up for a very low standard deviation environment
WN26	Data collected over 26 depth cells
WP1	Each ensemble averages over a single ping
WS10	Each depth cell is 0.1 m thick
WZ5	The mode 5 radial ambiguity velocity is set to 5 cm s^{-1}
TB01:00:00.00	The interval between bursts is one hour
TC00307	There are 307 ensembles per burst
TE00:00:01.00	The minimum interval between ensembles is one second
TP00:01.00	The minimum time between pings is set to one second
TF12/08/28, 12:00:00	The first ping was set to occur at noon on 28th August 2012
CK	Store the parameters set out above in non-volatile memory
CS	Start pinging

Table 12: Command file specifications for the 600 kHz ADCPs

Nortek Aquadropp

There were 61 Nortek Aquadropp current meters deployed on the moorings to give point measurements of velocity. The units were set up as shown in **Table 13**. The profilers estimate the current over 10 minute ensemble averages. They also have a diagnostic mode that works over 12 hour periods which allows the noise level of the instrument in that interval to be estimated.

SBE 37-SM MicroCAT

There were 61 Sea-bird Electronics 37-SM MicroCAT sensors deployed on the moorings to measure temperature and salinity. While there are additional thermistors on the inner and centre moorings, the SBE-37 units are the only instruments which can record the

Instrument	Nortek Aquadropp V. 1.3
Measurement interval	10 minutes
Averaging interval	1 minute
Blanking distance	35 cm
Diagnostic interval	12 hours
Diagnostic samples	20 minutes
Vertical velocity precision	1.4 cm s ⁻¹
Horizontal velocity precision	0.9 cm s ⁻¹
Salinity	35 ppt
Speed of sound	Measured (m s ⁻¹)
Compass upload rate	1 second
Coordinate system	ENU
File wrapping	Off
Assumed deployment duration	370 days

Table 13: Nortek Aquadropp specifications

salinity field. The units were set up as shown in **Table 14**. Note that the higher serial number units (listed first in **Table 14**) are a newer version of the instrument and were deployed on the centre and inner moorings. These perform ensemble averaging over five minutes, whereas the lower serial number units (listed second in **Table 14**) deployed on the outer moorings perform averaging over 10 minutes.

StarODDI thermistors

There were 248 StarODDI Starmon thermistors deployed, all of which were on the inner and centre moorings. The thermistors record temperature only i.e. they do not have pressure sensors. The sampling frequency is two minutes.

Model name and number	SBE 37SM-RS232 v4.1
Serial numbers	9371-9399
Start time	30th August 2012 12.00
Sample interval	5 minutes
Data format	“Converted engineering”
Output	Salinity
Transmit real-time	No
Sync mode	No
Pump installed	Yes
Minimum conductivity frequency	3326.9 Hz
Model name and number	SBE 37SM-RS232 3.0h
Serial numbers	7288-8079 (non-consecutive)
Start time	30th August 2012 12.00
Sample interval	10 minutes
Data format	“Converted engineering alternate”
Output	Salinity
Transmit real-time	No
Sync mode	No
Pump installed	Yes
Minimum conductivity frequency	3000.0 Hz

Table 14: SBE 37-SM MicroCAT specifications

Ship Systems Computing – *Martin Bridger*

All times are given in UTC.

Ship scientific computing systems.

Data was logged by the Techsas data acquisition system into NetCDF files. Data was additionally logged into the RVS Level-C format. An ASCII dump of each of the Level-C streams was included on the final data disk. A Public network drive was created to allow scientists to store and share their own data, reports and photographs. A copy has been included on the data disk.

Position and attitude.

All GPS and attitude measurement systems were run throughout the cruise. The POSMV system is the vessel's primary GPS system, outputting the position of the ship's common reference point in the gravity meter room. The POSMV is the GPS that is repeated around the vessel and sent out to other systems. The ADU5 would occasionally output a heading value of 999 when it was unable to calculate the correct heading. The DPS116 GPS unit was replaced at the beginning of the cruise during the port call, and has been working throughout the cruise. However occasionally it failed to output a position. The occasion that positions failed to be recorded for periods of 30 seconds or over were:

Start			End		
Year	Jday	Time	Year	Jday	Time
13	244	10:38:00	13	244	10:40:22
13	244	10:43:16	13	244	10:44:34
13	245	13:23:54	13	245	13:27:39
13	246	13:19:42	13	246	13:23:23
13	247	13:15:41	13	247	13:19:27
13	248	13:11:26	13	248	13:15:05
13	249	13:07:28	13	249	13:11:14
13	250	13:03:22	13	250	13:07:10
13	251	12:59:20	13	251	13:03:04
13	252	12:55:05	13	252	12:58:51
13	253	12:51:03	13	253	12:54:53
13	254	12:47:05	13	254	12:49:54
13	255	12:43:03	13	255	12:46:46
13	256	12:38:55	13	256	12:42:39
13	257	12:37:44	13	257	12:39:11
13	257	12:41:17	13	257	12:43:27

Meteorology and Sea Surface monitoring package.

The Surfmet system was run throughout the cruise. The non-toxic water supply was active from 08:50 on 1st September (day 244) until 13:22 on the 16th September. The non-toxic was briefly off between 09:09 and 09:24 on 8th September for maintenance.

Pumped seawater flow rates 1500 ml/min
 Anemometer orientation on bow 0 deg
 Seawater intake depth 5.5 m

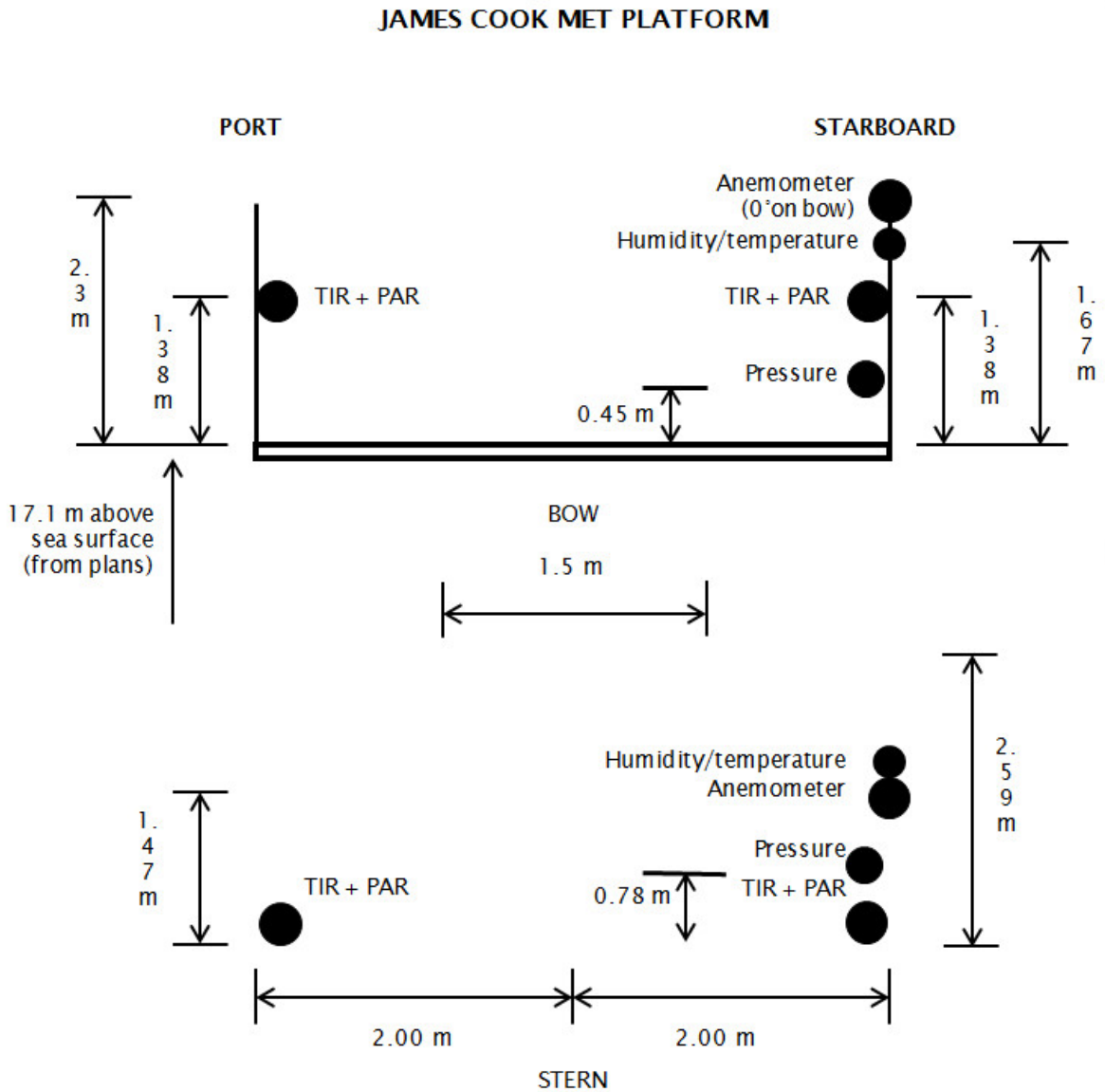

Figure 3: Details of the sensors fitted to the *RRS James Cook* Met. platform for cruise JC090.

Manufacturer	Sensor	Serial No.	Comments (eg. port)	Calibration applied?	Last calibration date
Skye	PAR	38884	Starboard	No	13/08/2012
Skye	PAR	28562	Port	No	22/09/2011

Continued on next page

Table 15 – continued from previous page

Manufacturer	Sensor	Serial No.	Comments (eg. port)	Calibration applied?	Last calibration date
Kipp & Zonen	TIR	973133	Starboard	No	10/7/2012
Kipp & Zonen	TIR	973132	Port	No	10/7/2012
Gill	Windsonic	064537		No	No cal
Vaisala	HMP45 Temp./Hum.	B4950010		No	06/07/2013
Vaisala	PTB100 Air Pres.	U1420016		No	21/3/2013
Wet Labs	WS3S Fluorimeter	WS3S-117		No	12/06/2013
Wet Labs	CST Transmissometer	CST-1132PR	Not used for 1st year so cal valid until 2014	No	19/7/2012
Sea-Bird	SBE38 Temperature	3854115-0490		No	12/12/2012
Sea-Bird	SBE45 TSG	4548881-0230		No	27/11/2012

Table 15: Sensors fitted for cruise JC090.

Other Ship fitted sensors

Manufacturer	Model	Function/data types	Logged? (Y/N)	Comments
Steatite	MM3S	GPS network time server (NTP)	N	Not logged but feeds times to other systems
Applanix	POS MV	DGPS and attitude	Y	Primary GPS
Ashtech	ADU-5	DGPS and attitude	Y	
C-Nav	3050	DGPS and DGNSS	Y	
Kongsberg Seatex	DPS116	Ship's DGPS	Y	Bridge GPS
Kongsberg Seatex	Seapath 200	DGPS and attitude	Y	Secondary GPS

Continued on next page

Table 16 – *continued from previous page*

Manufacturer	Model	Function/data types	Logged? (Y/N)	Comments
Sonardyne	Fusion USBL	USBL	N	
Sperry Marine		Ship gyrocompasses x 2	Y	
Chernikeeff Instruments	Aquaprobe Mk5	Electromagnetic speed log	Y	
Kongsberg Maritime	Simrad EA600	Single beam echo sounder (hull)	Y	
Kongsberg Maritime	Simrad EA500	Single beam echo sounder (hull)	N	Used to track pingers, no data logged
Kongsberg Maritime	Simrad EM120	Multibeam echo sounder (deep)	Y	
Kongsberg Maritime	Simrad EM710	Multibeam echo sounder (shallow)	N	Not used this cruise
Kongsberg Maritime	Simrad SBP120	Sub bottom profiler	N	
Kongsberg Maritime	Simrad EK60	Scientific echo sounder (fisheries)	N	
NMFSS	CLAM	CLAM system winch log	Y	
NMFSS	Surfmet	Meteorology suite	Y	
NMFSS	Surfmet	Surface hydrography suite	Y	
		Skipper log (ship's velocity)	Y	
OceanWaveS GmbH	WaMoS II	Wave Radar	Y	
Teledyne RD Instruments	Ocean Observer 75 kHz	VM-ADCP	Y	
Teledyne RD Instruments	Ocean Observer 150 kHz	VM-ADCP	N	Transducer Removed for Repair
Microg La-coste	Air-Sea System II	Gravity	Y	Meter S40 fitted this cruise

Table 16: BODC Ship-fitted Systems Information Sheet (*RRS James Cook* cruise JC090) Logging status of ship-fitted instrumentation and suites

PCO2

The PCO2 system ran throughout the cruise. Data is available from PML.

Kongsberg EA600 12 kHz single beam echo sounder.

The EA600 single beam echo sounder was run throughout the cruise. The EA600 was used with a constant sound velocity of 1500 ms^{-1} throughout the water column to allow it to be corrected for sound velocity in post processing. As well as depths being logged to the Techsas and Level-C data loggers, files were saved as .BMP images and in raw Kongsberg format.

Kongsberg EM120 Deep Water Multi-beam echo sounder.

The EM120 multi-beam echo sounder was run throughout the cruise to provide general depth information in addition to the single beam system. Data was logged in Kongsberg .all format. The centre beam depth was logged to Techsas and Level-C. No calibration of the EM120 took place. Figure 4 below shows the angular offsets used by the system, and were obtained from the calibration during the previous cruise.

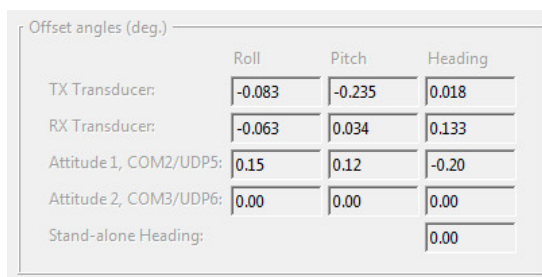

	Roll	Pitch	Heading
TX Transducer:	-0.083	-0.235	0.018
RX Transducer:	-0.063	0.034	0.133
Attitude 1, COM2/UDP5:	0.15	0.12	-0.20
Attitude 2, COM3/UDP6:	0.00	0.00	0.00
Stand-alone Heading:			0.00

Figure 4: EM120 angular offsets.

Hull mounted ADCP system.

The 75 kHz ADCP system was run during the cruise. The raw data files and configurations are included on the data disk. No 150 kHz ADCP was fitted to the vessel during this cruise as the transducer was being repaired at the manufacturer.

WAMOS Wave Radar.

The WAMOS wave radar was run throughout the cruise. All data was logged, but a summary of its output is given in the Para*.jco files.

CTD Operations – *Paul Provost*

CTD System Configuration

	Sea-Bird <i>9plus</i> underwater unit, s/n: 09P-54047-0943
Frequency 0	Sea-Bird 3 Premium temperature sensor, s/n: 03P- 2919
Frequency 1	Sea-Bird 4 conductivity sensor, s/n: 04C-2841
Frequency 2	Digiquartz temperature compensated pressure sensor, s/n: 110557
Frequency 3	Sea-Bird 3 Premium temperature sensor, s/n: 03P - 4151
Frequency 4	Sea-Bird 4 conductivity sensor, s/n: 04C-3698
V0	Sea-Bird 43 dissolved oxygen sensor, s/n: 43-1882
V1	Free
V2	CTG 2p-PAR, UWIRR, s/n: PAR 007 (UWIRR)
V3	CTG 2p-PAR, DWIRR, s/n: PAR 002 (DWIRR)
V4	CTG transmissometer, s/n: 09-7107-001
V5	CTG Aquatracka MKIII fluorimeter, s/n: 088195
V6	WETLabs turbidity sensor, s/n: BBRTD-168
V7	Benthos PSA-916T altimeter, s/n: 41302

Ancillary instruments & components:

Sea-Bird *11plus* deck unit, s/n: 11P-24680-0587
Sea-Bird 24-position Carousel, s/n: 32-31240-0423
24 x Ocean Test Equipment 20L water samplers, s/n's: 1b through 24b
TRDI WHM 300kHz LADCP, s/n: 15288
NOCS LADCP battery pack, s/n: WH005

CTD Operations

In total there were 9 CTD casts made using the stainless steel system. Log sheets were scanned and included with the data from this cruise. The pressure sensor was located 33cm below the bottom and approximately 70cm below the centre of the 10L water sampling bottles. The configuration file used for all casts was *JC090_ss.xmlcon* (see Appendix below).

For casts 2, 4, 5 and 6 the PAR sensors were added. For all other casts the PAR sensors were removed. On each cast of 7, 8 and 9, 20 SBE37SMP Microcat CTDs were added to compare the instruments for a field calibration (i.e., 60 instruments in total).

CTD wire 1 was used throughout, only once being terminated at the start of the cruise. In an attempt to prevent the wire from “un-wrapping”, the wire was streamed once, prior to any CTD cast taking place, to 4,500m. A 600kg weight with a swivel attached was used as a weight on the wire.

Total number of casts:	9
Casts deeper than 2000m	0
Deepest cast	1000m

Data Processing

Post-processing the CTD cast data was basically to guidelines established with BODC (ref. Moncoiffe 7th July 2010), but as the sea was relatively calm during casts the Loop Edit, Wild Edit and Strip routines were not used.

Salinity measurement

A Guildline Autosol 8400B salinometer, s/n: 60839, was used for salinity measurements. The salinometer was set up in the Electronics Workshop, with the bath temperature set at 21°C, the ambient temperature being approximately 19°C. A bespoke program written in Labview called “Autosal” was used as the data recording program for salinity values.

The salinometer was standardized at the beginning of the first set of samples, and checked with an additional standard analysed prior to setting the RS. Once standardized the Autosol was not adjusted for the duration of sampling. Additional standards were analysed every 24 samples to monitor & record drift. These were labelled sequentially, beginning with number 999 and thereafter decreasing. Standard deviation set to 0.00002. Salinity samples were taken and analysed from casts 1 to 9 inclusive.

TRDI LADCP Configuration

The TRDI WHM 300kHz LADCP (s/n: 15288) was deployed in a downward-looking orientation on the CTD frame. Battery voltage could be monitored as the cable was not diode protected. The instrument was configured to ping at intervals of one second, use 16 bins, a blanking distance of 5m and a depth cell size of 10m thus yielding a range of approximately 165m in ideal conditions. The ambiguity velocity was set to 250 cms⁻¹ and pings per ensemble to 1.

Built-in pre-deployment tests (*PA and PT200*) were run before each cast, and then the following command file sent (*F2*):

```
>CR1
[Parameters set to FACTORY defaults]
>CF111101
>EA00000
>EB00000
>ED00000
>ES35
>EX111111
>EZ00111101
>TE00:00:01.00
>TP00:01.00
>WM15
>LD1111100000
>LF0500
>LN016
>LP00001
>LS1000
```

```
>LV250
>LW1
>SM1
>SIO
>SA001
>SW05000
>CK
[Parameters saved as USER defaults]
>CS
```

Deployment Comments

Each deployment BBtalk terminal session was logged to a file (*F3*) of the form: *JC090_XXM.txt*, where *XX* is the CTD cast number. Downloaded data files were re-named to be of the form: *JC090_XXM.000*.

The real-time clock of the LADCP was checked prior to deployment (*TS?*) and re-synchronised with the ship's GPS clock if it was more than a few seconds in error. The time difference was written on the log sheet.

Paper log sheets were used for all casts, the LADCP file number being defined by the CTD cast number. These were also scanned and available in electronic format.

APPENDIX *JC090_ss.xmlcon*

Instrument configuration file: C:\Program Files\Sea-Bird\SeasaveV7\JC090\JC090_ss.xml

Configuration report for SBE 911plus/917plus CTD

```
-----
Frequency channels suppressed : 0
Voltage words suppressed      : 0
Computer interface            : RS-232C
Scans to average              : 1
NMEA position data added      : Yes
NMEA depth data added         : No
NMEA time added               : No
NMEA device connected to     : deck unit
Surface PAR voltage added     : No
Scan time added               : No
```

1) Frequency 0, Temperature

```
Serial number : 03P-2919
Calibrated on : 15 Feb 2013
G              : 4.31705918e-003
H              : 6.44487661e-004
I              : 2.28169462e-005
J              : 2.13085582e-006
```

F0 : 1000.000
Slope : 1.00000000
Offset : 0.0000

2) Frequency 1, Conductivity

Serial number : 04C-2841
Calibrated on : 27 July 2012
G : -1.03700800e+001
H : 1.42962199e+000
I : 1.69435010e-004
J : 5.89321805e-005
CTcor : 3.2500e-006
CPcor : -9.57000000e-008
Slope : 1.00000000
Offset : 0.00000

3) Frequency 2, Pressure, Digiquartz with TC

Serial number : 110557
Calibrated on : 29 May 2012
C1 : -6.010548e+004
C2 : -1.565601e+000
C3 : 1.823090e-002
D1 : 2.668300e-002
D2 : 0.000000e+000
T1 : 3.020528e+001
T2 : -6.718318e-004
T3 : 4.457980e-006
T4 : 1.203850e-009
T5 : 0.000000e+000
Slope : 0.99998000
Offset : -0.22270
AD590M : 1.280700e-002
AD590B : -9.299640e+000

4) Frequency 3, Temperature, 2

Serial number : 03P-4151
Calibrated on : 15 Feb 2013
G : 4.39926497e-003
H : 6.69841628e-004
I : 2.50707213e-005
J : 2.02533774e-006
F0 : 1000.000
Slope : 1.00000000

Offset : 0.0000

5) Frequency 4, Conductivity, 2

Serial number : 04C-3698
Calibrated on : 12 December 2012
G : -1.01501091e+001
H : 1.43729361e+000
I : -2.77892866e-003
J : 2.90925992e-004
CTcor : 3.2500e-006
CPcor : -9.57000000e-008
Slope : 1.00000000
Offset : 0.00000

6) A/D voltage 0, Oxygen, SBE 43

Serial number : 43-1882
Calibrated on : 2 Aug 2011
Equation : Sea-Bird
Soc : 4.95300e-001
Offset : -4.97700e-001
A : -3.48380e-003
B : 1.72570e-004
C : -2.70170e-006
E : 3.60000e-002
Tau20 : 1.33000e+000
D1 : 1.92634e-004
D2 : -4.64803e-002
H1 : -3.30000e-002
H2 : 5.00000e+003
H3 : 1.45000e+003

7) A/D voltage 1, Free

8) A/D voltage 2, PAR/Irradiance, Biospherical/Licor

Serial number : 007
Calibrated on : 02 May 2012
M : 0.47653200
B : 1.05683900
Calibration constant : 100000000000.00000000
Multiplier : 0.99960000
Offset : 0.00000000

9) A/D voltage 3, PAR/Irradiance, Biospherical/Licor, 2

Serial number : 002
Calibrated on : 07 May 2013
M : 0.47913900
B : 0.10592530
Calibration constant : 100000000000.00000000
Multiplier : 0.99960000
Offset : 0.00000000

10) A/D voltage 4, Transmissometer, Chelsea/Seatech/WET Lab CStar

Serial number : 09-7107-001
Calibrated on : 11 June 2012
M : 23.7954
B : -0.1452
Path length : 0.250

11) A/D voltage 5, Fluorometer, Chelsea Aqua 3

Serial number : 088195
Calibrated on : 21 August 2012
VB : 0.612800
V1 : 1.973000
Vacetone : 0.635000
Scale factor : 1.000000
Slope : 1.000000
Offset : 0.000000

12) A/D voltage 6, Turbidity Meter, WET Labs, ECO-BB

Serial number : BBRTD-168
Calibrated on : 24 September 2012
ScaleFactor : 0.003764
DarkVoltage : 0.070000

13) A/D voltage 7, Altimeter

Serial number : 41302
Calibrated on : 13 March 2006
Scale factor : 15.000
Offset : 0.000

Scan length : 37

Seaglider Recoveries – *Madeleine Youngs and Steve Woodward*

Recovery Timeline

- 4th September Gliders put into shallow dives to prepare for recoveries and then returned to deep dives.
- 5th September Gliders interrogated using Benthos box with no response.
- 7th September Gliders recovered and 566 cleaned and self-test.
- 8th September 533 cleaned.

False Recovery

On September 4th the seagliders (SG533 and SG566) were put into shallow dives to prepare for recovery at the center. Over the night before we lost communication with SG566 for one call in (NOCS PSTN line) but the comms with SG533 (NOCS RUDICS line) were fine. The recovery was canceled due to bad weather with a wind speed of 20 knots and a significant wave height of 2 m. The gliders were then returned to deep dives and sent to SW_OUT.

Acoustic Interrogations

On the 5th of September, we interrogated the seagliders from a distance of about 2 km from SG566 and about 2.5 km from SG533. The Benthos DB8000 was hooked up to two different shipboard transducers and was lowered off of the starboard CTD bay. These tests were done between 17:30 and 17:50 UTC. During this time the significant wave height was around 1.6 m and the wind speed was about 20 knots. No response was ever received from either Seaglider. We believe this is due to lack of range on the return ping of the Seagliders. Throughout the cruise, the onboard OLEX system was used to mark the position of the gliders relative to the ship.

Recovery

On the base station, a file of GPS locations was created for the pilots to send the fixes to the ship, in case the emails were taking too long or not at all, as ssh on the ship can work better than email. We planned to recover SG566 first, but it missed a call in around 1:30 UTC on the 7th of September. We recovered SG533 first because it was ready in shallow dives first. The QUIT command was put in at 7:12 UTC, and she was spotted by Liam before the first GPS email came in. She was hooked by 7:54 UTC and on board via the CTD winch by 7:56 UTC. Once 533 was being hooked (it took a while) we put 566 in recovery at 7:57 UTC. She was sighted at 8:10 UTC, again by Liam, and hooked by 8:40 UTC and brought on board by 8:42 UTC.

We used the Recovery Loop method to recover the Seagliders as employed on previous OSMOSIS cruises. This method is not ideal as Seagliders were designed to be recovered in a small boat. The method pretty much worked as planned, but weights were added to recovery loop to allow it to sink below the surface. For the recovery of 533, the rope used

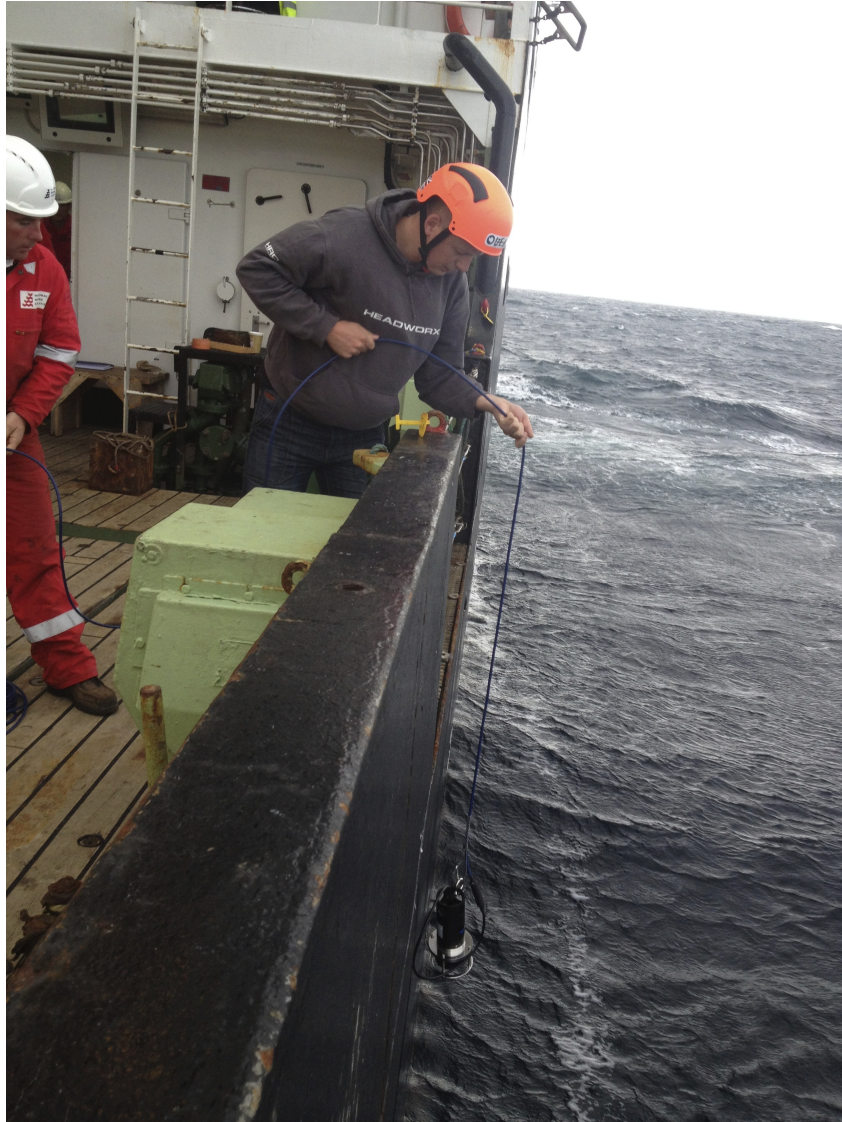

Figure 5: Steve lowering the deck unit into the water for acoustic interrogation of the Seagliders.



Figure 6: (Left) 533 being recovered with the rope wrapped around half the rudder and the antenna. (Right) 566 being recovered with the rope wrapped around half the rudder.

to hoist the glider on deck, hooked on to one side of the rudder and around the antenna. On 566, the rope hooked around one side of the rudder only. Both Seaglidors made it on board safely into their cradles.

Neither Argos tag transmitted during the recovery. Both transmitted once they were dry on the ship, with no information on interval nor range.

Cleaning and Self-test

Both 533 and 566 were host to algae and small goose barnacles. The goose barnacles were around 5 mm to 10 mm long. The Seaglidors were rinsed with freshwater and fairings scrubbed using scotchbrite. Many of the goose barnacles needed to be cleaned out using a screwdriver as their stalks grew into small crevices. A deep cleaning will be necessary to remove all of the missed goose barnacle bits. A full cleaning kit would be useful for this type of biofouling in the future.



Figure 7: Goose barnacles and algae on Seaglider 566.

A self-test was run on 566 on September 7th. The files were attempted to upload to the NOCS base station but the glider didn't have good enough comms, probably due to a sub-optimal location of 566 due to the continuation of mooring operations. The files were then transferred off the glider, to be processed at a later date.

4 SCIENTIFIC INVESTIGATIONS

Microstructure Measurements – *Natasha Lucas, Josh Griffiths, Alex Forryan and Graeme MacGilchrist.*

Objectives

1. To provide profiles of epsilon (ϵ) through the surface mixed layer, seasonal thermocline and transition zone in order to test:
 - (a) The *Grant & Belcher* Langmuir circulation parameterisation
 - (b) The hypothesis that inertial shear spikes generated by the alignment of the wind vector with the surface inertial currents leads to enhanced diapycnal mixing.
2. To provide data against which the ADCP structure function-based ϵ time series and turbulence glider-based ϵ profiles can be tested.

Method

The measurements were made using a MSS90 loosely tethered microstructure profiler produced by Sea and Sun Technology GmbH and ISW Wassermesstechnik. The profiler is cylindrical in shape with two PNS shear probes and several other sensors, including conductivity, temperature, fast response temperature, fluorimetry and pressure. The shear probes make direct measurements of cross-axial velocity fluctuations using a piezoceramic beam. Data from the sensors are recorded continuously on a PC laptop, connected to the descending profiler via a slack tether and winch system. The profiler has a drop speed of approximately 0.85ms^{-1} , a compromise which allows profiles to be taken as rapidly as possible whilst minimising noise effects.

The profiler was deployed from a winch mounted on the port aft gunwale and was allowed to free-fall to a depth of about 200m. The complete profile (i.e. recorded descent and unrecorded ascent) took on average 8-10 minutes, thus producing 6-7 profiles an hour. During the deployments the ship speed relative to the water was held at 0.3-0.5 knots where possible. This was to avoid the line being drawn back under the ship and thus risking the line becoming entangled in the ship's propeller.

Although complete redundant systems were available onboard, the sampling program was conducted in full using profiler, winch, motor, and cable supplied by the NOCS contingent.

We aimed at obtaining profiles to around 200m thus covering the surface mixed layer, seasonal thermocline and transition layer. In order to do so, the profiler was deployed to a depth of approximately 200m with a few turns of slack cable always visible in the water. When the profiler reached 200m, the winch operator would be instructed to begin hauling in the tether cable, with the profiler normally reaching a depth of approximately 230m, depending on the amount of slack cable and the vessel speed. Temperature and conductivity sensors allow the mapping of turbulence simultaneously with the upper water column hydrography.

During cruise JC090, quasi-continuous night time measurements were taken between the dates of 2/9/13 and 9/9/13, which incorporated 327 profiles, these were run by a team

of four-six enabling profiling at the optimum periods of sunset and sunrise when this did not conflict with mooring recovery. The location of these transects varied according to mooring recovery requirements with the direction of steaming chosen according to the wind/wave conditions; in order to maintain both the slow speed necessary for profiler deployment and control of the ship.

Following the mooring recovery, shifts were changed to facilitate longer profiling series. These measurements were taken between the dates of 9/9/13 - 13/9/13, which incorporated 362 profiles. For these longer sessions MSS transects were carried out covering the PAP array along a track from the previous site of the NE-outer to the SW-outer moorings. Each time-window incorporated steam back to reposition (with occasional detour for other science such as the PAP buoy service) and an accompanying 500m CTD cast once per transect, predominantly to collect coincident nutrient data to enable calculation of diapycnal nutrient fluxes into the surface mixed layer.

Ses. No.	Day No. of first profile	Start date/time (GMT)	End date/time (GMT)	Total time (hrs - mins)	Last prof.	No. prof. in ses.	Notes
1	245	02/09/2013 21:56	03/09/2013 05:11	07 - 15	46	46	
2	246	03/09/2013 21:04	04/09/2013 05:17	08 - 13	98	52	
3	247	04/09/2013 23:41	05/09/2013 06:48	07 - 07	130	32	
4	248	05/09/2013 20:21	06/09/2013 06:41	10 - 20	170	40	
5	249	06/09/2013 19:52	07/09/2013 07:02	11 - 10	226	56	
6	250	07/09/2013 19:11	08/09/2013 08:41	13 - 30	287	61	
7	251	08/09/2013 19:59	09/09/2013 02:46	06 - 47	327	40	Shift change from 12hr to 4hr so early finish.
8	252	09/09/2013 17:25	10/09/2013 05:53	12 - 28	395	68	
9	253	10/09/2013 09:42	11/09/2013 04:39	18 - 57	507	112	Winch transformer breakdown - repaired for next session.
10	254	11/09/2013 18:40	12/09/2013 14:43	20 - 03	621	114	

Continued on next page

Table 17 – *continued from previous page*

Ses. No.	Day No. of first profile	Start date/time (GMT)	End date/time (GMT)	Total time (hrs - mins)	Last prof.	No. prof. in ses.	Notes
11	255	12/09/2013 20:08	13/09/2013 01:34	05 - 26	654	33	Stopped due to starboard prop failure and near loss of MSS! Cable re-terminated for next session
12	256	13/09/2013 13:36	13/09/2013 19:40	06 - 04	689	35	

Table 17: Summary of MSS profiler sessions.

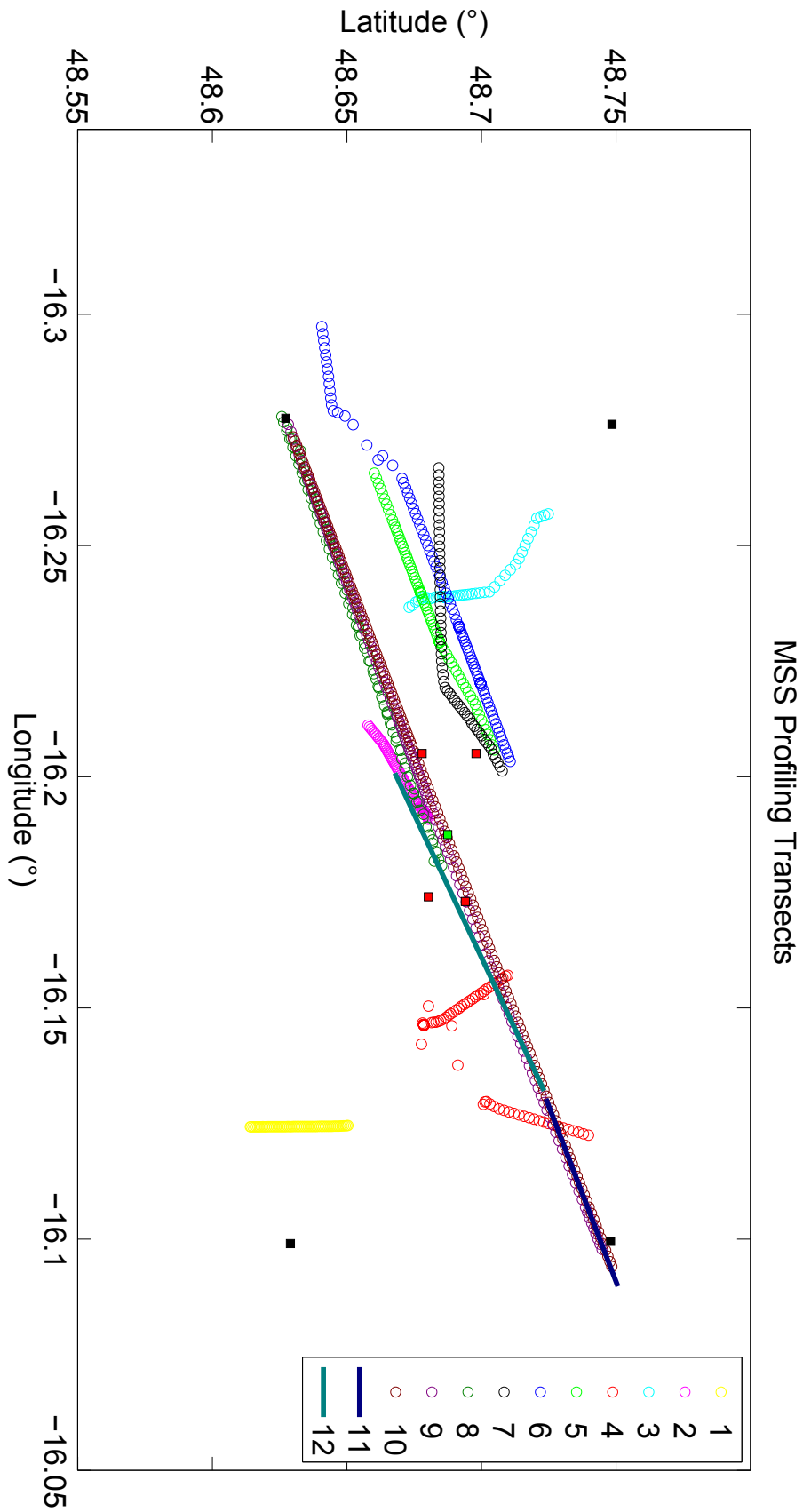

Figure 8: Map of MSS profiling stations over the duration of the cruise showing representative full transects for sessions 1 to 10 and estimated transects for sessions 11 and 12. The black, red and green squares represent the outer, inner and central buoys respectively.

Profiler Details

The NOC profiler was used throughout (Serial number MSS050). The profiler was equipped with the following sensors:

- 2 velocity microstructure shear sensors (Shear 1: D098 and Shear 2: D099)
- A fluorimeter sensor
- A microstructure temperature sensor
- Standard CTD sensors for precision measurements
- A two component tilt sensor and surface detection sensor

Two shear sensors are fitted on the MSS profilers to provide both duplicate measurements, and provide a comparison in case of failure of a sensor (mode of failure is generally a lack of sensitivity).

Shear sensor calibration coefficients:

$$\text{D098: } a_0 = 3.453828 \times 10^{-3}; a_1 = 6.907663 \times 10^{-3}$$

$$\text{D099: } a_0 = 2.862511 \times 10^{-3}; a_1 = 5.725028 \times 10^{-3}$$

Data was processed from raw shear signals through to TKE dissipation rate (ϵ) using the MSSPRO software standard processing sequence (e.g. *Venables, 2011*).

Examples of Data

Examples of data collected from the longest time series, commencing the 11th September 2013, are shown on the following pages. In addition, estimates of Langmuir parameters are included.

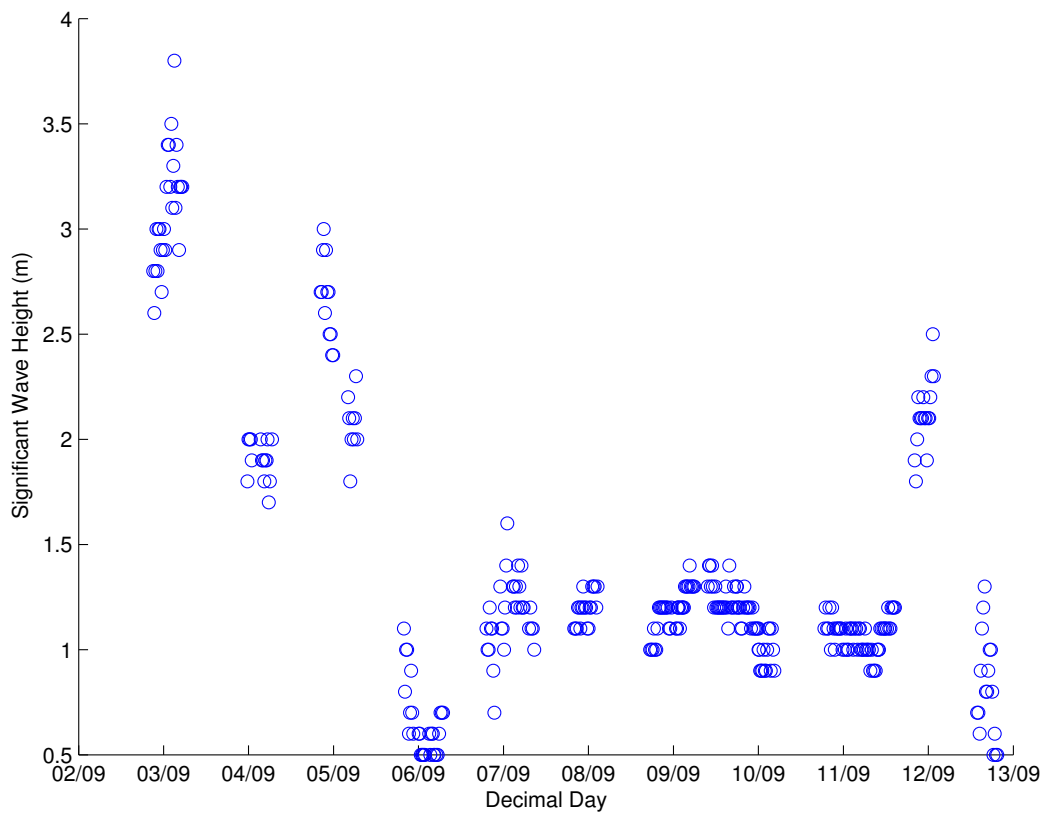

Figure 9: Significant wave height observed by the ship's radar over the cruise period, noted on alternate MSS profiles.

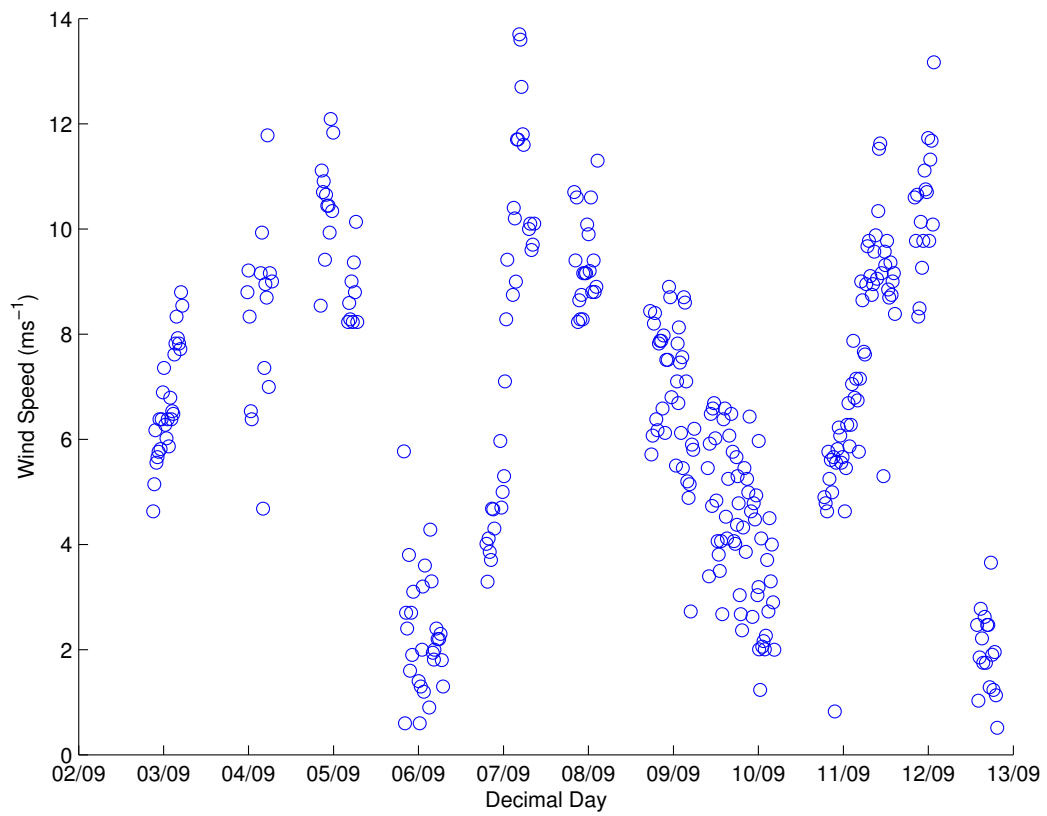

Figure 10: Wind speed measured by the ship's meteorological station over the cruise period, noted on alternate MSS profiles.

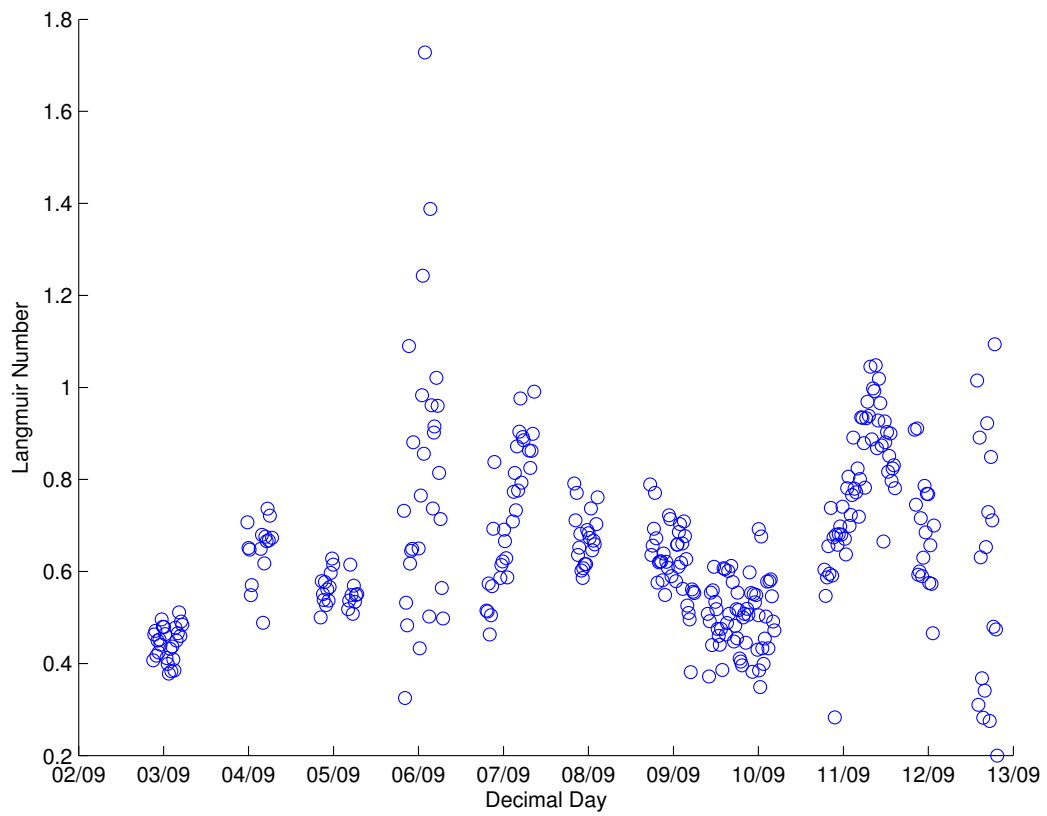

Figure 11: Estimate of Bulk Langmuir number ($La^2 = u_*/u_{s0b}$) from ship based wind measurements and ship based estimates of significant wave height and period, noted on alternate MSS profiles.

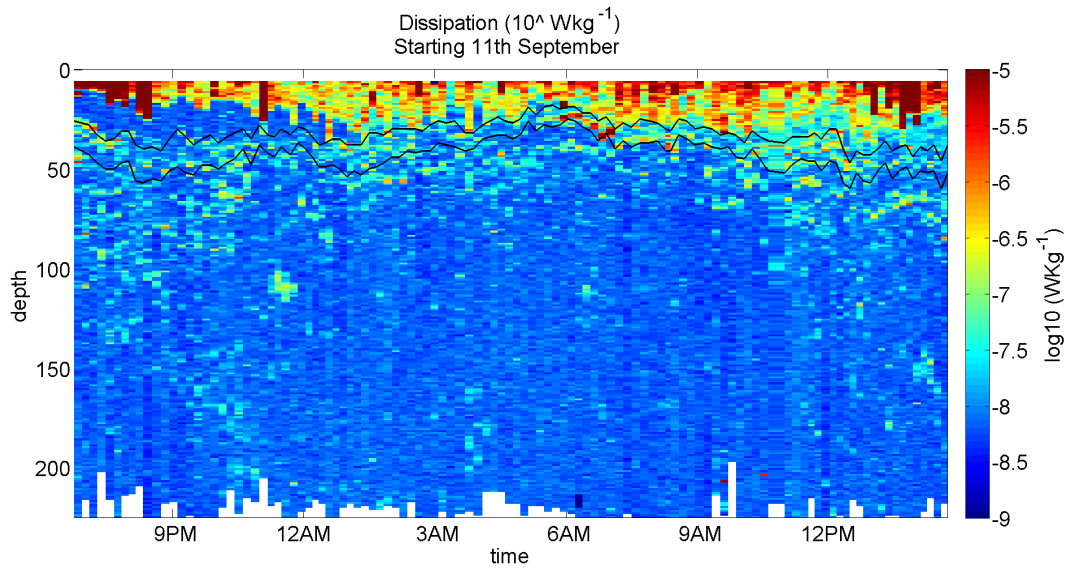

Figure 12: Turbulent dissipation contour plot for session 10, from 18:40 on the 11th September 2013 to 14:43 on the 12th September 2013, from the MSS profiler. Black lines represent the mixed layer depth (*de Boyer Montégut, 2004*) and the base of the transition layer (*Johnston & Rudnick, 2009*).

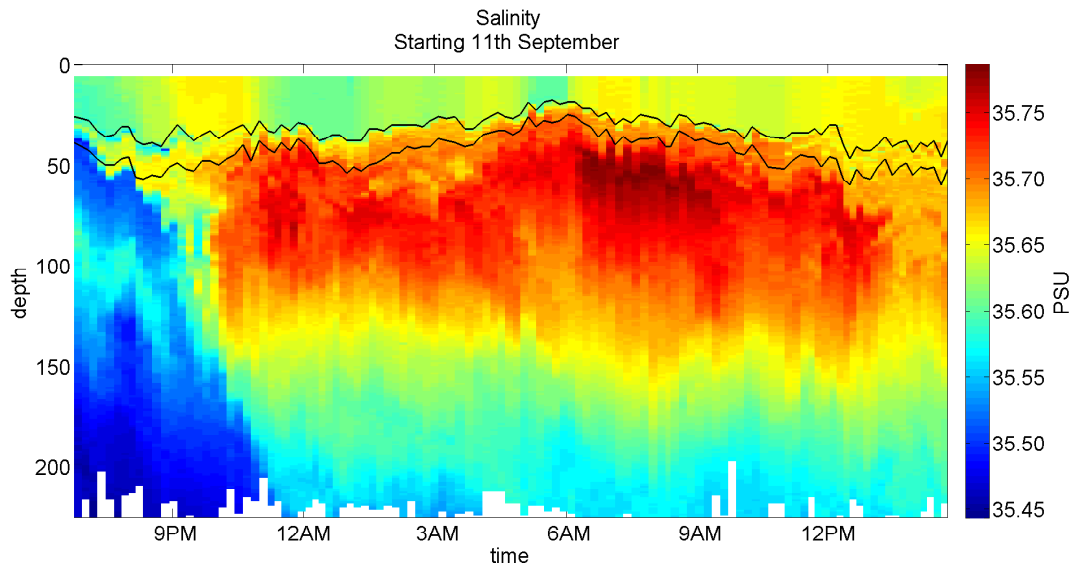

Figure 13: Salinity contour plot for the session 10, from 18:40 on the 11th September 2013 to 14:43 on the 12th September 2013, from the MSS profiler. Black lines represent the mixed layer depth (*de Boyer Montégut, 2004*) and the base of the transition layer (*Johnston & Rudnick, 2009*).

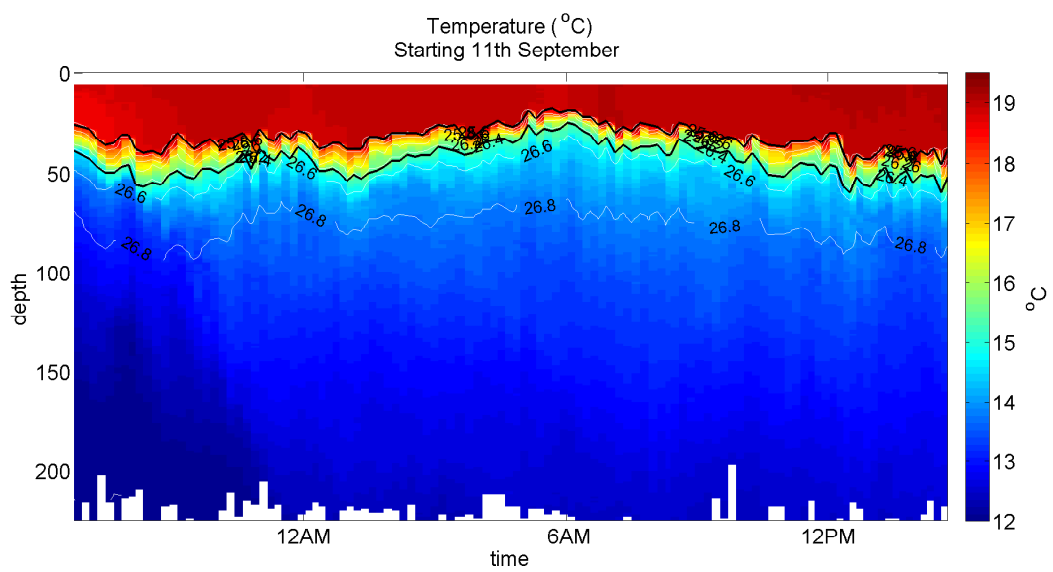

Figure 14: Temperature contour plot for the session 10, from 18:40 on the 11th September 2013 to 14:43 on the 12th September 2013, from the MSS profiler. Black lines represent the mixed layer depth (*de Boyer Montégut, 2004*) and the base of the transition layer (*Johnston & Rudnick, 2009*).

References

- de Boyer Montégut, C. (2004).** *Mixed layer depth over the global ocean: An examination of profile data and a profile-based climatology.* Journal of Geophysical Research. **109**(C12). 1:20. doi:10.1029/2004JC002378
- Johnston, T. M. S., and Rudnick, D. L. (2009).** *Observations of the Transition Layer.* Journal of Physical Oceanography. **39**(3). 780:797. doi:10.1175/2008JPO3824.1.
- Venables, E. J. (2011).** *Shear-Induced Vertical Mixing in the Wyville Thompson Basin: A Study of its Driving Mechanisms, Strength, and Influence.* PhD Thesis, Univ. Aberdeen. 175pp.

CTD Data Processing and Calibration – *Alex. Forryan*

Summary of CTD deployments

A summary of all CTD casts is given in Table 18.

No.	Date	Time (GMT)	Latitude (°N)	Longitude (°E)	Water Depth (m)	Sal	O ₂	Comments
1	Sep 03 2013	05:49:45	48 40.81	-016 11.44	4813	Y	Y	1000 m cast
2	Sep 03 2013	19:34:57	48 40.81	-016 11.44	4813	Y	Y	200 m cast
3	Sep 04 2013	13:01:23	48 40.96	-016 09.54	4816	Y		1000 m cast
4	Sep 04 2013	21:39:52	48 40.11	-016 13.98	4816	Y		200 m cast
5	Sep 06 2013	18:03:21	48 38.79	-016 15.63	4810	Y	Y	200 m cast
6	Sep 08 2013	18:38:57	48 42.61	-016 12.17	4813	Y		200 m cast
7	Sep 12 2013	15:27:08	48 37.69	-016 16.56	4807	Y		MicroCat calibration to 600 m
8	Sep 13 2013	09:29:49	48 37.95	-016 16.37	4807			MicroCat calibration to 600 m
9	Sep 14 2013	08:59:23	47 32.28	-013 20.11	4656	Y		MicroCat calibration to 600 m

Table 18: Summary of all CTD casts on cruise JC090.

Initial Processing Using SeaBird Programs

The files output by Seasave have the appendices: .hex, .HDR, .bl and .CON. The .CON files for each cast contain the calibration coefficients for the instrument. The .HDR files contain the information in the header of each cast file. The .hex files are the data files for each cast and are in hex format. The .bl files contain information on the bottle firing of the rosette. Files produced by the autonomous titanium frame unit and the conventional stainless steel frame unit were processed in exactly the same way.

Initial data processing was performed on a PC using the SeaBird processing software SBE Data Processing version 7.21b. The following options were used in the given order :

- *Data Conversion*: turns the raw data into physical units. It takes the .CON files and .hex files. The input files were named JC090.nnn.hex where nnn refers to the three-digit station number.
- *Cell Thermal Mass*: takes the .cnv files output from data conversion and makes corrections for the thermal mass of the cell, in an attempt to minimize salinity

spiking in steep vertical gradients due to a temperature/conductivity mismatch. The constants applied were; thermal anomaly amplitude $\alpha = 0.03$; thermal anomaly time constant $1/\beta = 7$.

- *Bottle_Summary*: generates an ASCII summary .bl file of the bottle firing data from the cast .ros file. This must contain the CTD scan number for each bottle firing.

Mstar CTD Processing

The entire Mstar software suite is written in Matlab and uses NetCDF file format to store all the data. There are four principal types of files:

- *SAM* files: store all information about rosette bottles samples, including upcast CTD data from when the bottles were fired. Data from chemistry samples corresponding with each bottle are uploaded into this file as well. Other information about the station is stored too.
- *CTD* files: store all data from CTD sensors. There are five CTD files: raw, 24Hz, 1Hz, psal and 2db. The program averages and interpolates the raw data until it has 2db resolution.
- *DCS* files: store information necessary to know CTD downcast (for e.g. start, bottom and end points of the cast). It is also used to merge in latitude and longitude.
- *FIR* files: keep information about CTD data in points when each rosette bottle was fired. Also stores information about winch work.

Processing Procedure

After having converted the CTD cast data with the SBE processes, there were two ASCII files to work on: ctd_jc090_nnn_ctm.cnv and ctd_jc090_nnn.bl. The first one contains all raw CTD data including cast information. The other one contains information about the firing of each bottle on the cast. To start the CTD data processing, m_setup was run in Matlab to add Mstar tools and information needed for the processing. The following scripts were then run:

- *msam_01*: creates an empty sam file to store all information about rosette bottle samples. The set of variables are available in the /templates directory and can be changed according to what it needs to store. This file, named as sam_jc090_nnn.nc, stores data for each sample bottle, their flags, and some CTD data at firing time.
- *mctd_01*: reads the raw data (ctd_jc090_nnn_ctm.cnv) and stores it in a NetCDF file named ctd_jc090_nnn_raw.nc, which becomes write protected.
- *mctd_02a*: copies ctd_jc090_nnn_raw.nc into ctd_jc090_nnn_24hz.nc renaming the variables for the SBE sensor.
- *mctd_02b*: using 24Hz data (ctd_jc090_nnn_24hz.nc), applies oxygen hysteresis correction to variable oxygen_sbe to create new variable oxygen.

- *mctd_03*: using 24Hz data (ctd_jc090_nnn_24hz) it averages to 1Hz data. Then, using the 1Hz file (ctd_jc090_nnn_1hz) it calculates salinity and potential temperature (ctd_jc090_nnn_psal). This script also calls *mctd_sensor_choice.m*, which records the first choice conductivity-temperature sensor pair for each station. First choice sensor data is then stored in the variables *temp* and *cond* (which are subsequently used to calculate variables *potemp* and *psal*).
- *mdcs_01*: creates an empty file named as dcs_jc090_nnn to store information about the start, bottom and end of the cast.
- *mdcs_02*: populates dcs_jc090_nnn with information from the bottom cast. It takes the highest pressure point as bottom.
- *mdcs_03*: selects and shows surface data < 20db (ctd_jc090_nnn_surf) allowing the analyst to choose the positions of the start and end scan numbers. The start is selected by scrolling from the top of data printed out by mdcs_03. The operator identifies where the CTD went from being on deck (zero/negative pressure) to roughly 10db and then the point where it was brought back to the surface for the start of the downcast. The scan number at which the pressure begins to increase and temperature, salinity and oxygen data show reasonable values is selected as the start point of the downcast. To find the end of upcast, the data were scrolled up from the bottom to identify where the CTD came back onboard. The operator chooses the last available point where sensor values are reasonable before an abrupt change in measurements occurs as the CTD is lifted out of the water.
- *mctd_04*: using information on dcs_jc090_nnn it selects the CTD downcast data from ctd_jc090_nnn_psal file and averages it into 2db resolution (ctd_jc090_nnn_2db).
- *mdcs_04*: loads position from navigation file and merges it on the cast's points previously defined in mdcs_03, and stores it in dcs_jc090_nnn_pos.nc.
- *mfir_01*: extracts information about fired bottles from ctd_jc090_nnn.bl and copies them into a new file named fir_jc090_nnn.bl.nc.
- *mfir_02*: using fir_jc090_nnn.bl and ctd_jc090_nnn_1hz it merges the time from the CTD using scan numbers and puts it into a new file (fir_jc090_nnn_time.nc).
- *mfir_03*: stores the CTD data at each bottle firing time in fir_jc090_nnn_ctd. The CTD data are taken from ctd_jc090_nnn_psal and selected according to the firing time information stored in fir_jc090_nnn_time.
- *mfir_04*: copies information of each bottle from fir_jc090_nnn_ctd onto sam_jc090_nnn.
- *mwin_01*: creates a new file named win_jc090_nnn.nc to store information about winch working (for e.g. angles, rate and tension).
- *mwin_03*: using time stored in fir_jc090_nnn_time, it selects wire-out from win_jc090_nnn at each bottle firing location to fir_jc090_nnn_winch.
- *mwin_04*: pastes wire-out information from fir_jc090_nnn_winch into sam_jc090_nnn.nc.

- *mdcs_05*: applies positions from *dcs_jc090_nnn_pos.nc* to all files. If a file on the set doesn't exist yet it won't be uploaded.

Sample Files

The sample files (*sam_jc090_nnn.nc*) were created whilst processing each CTD station. These were filled with upcast conductivity, temperature, oxygen and pressure from both primary and secondary sensors coincident with bottle firings. Only the results from salinity and oxygen sampling were included in the sample files.

For salinity samples the following scripts were run:

- *msal_01*: creates a salinity sample file (*sal_jc090_nnn.nc*) to store the results from the salinity sample analysis. It uses a text file (comma separated) named *sal_jc090_nnn.csv* which contains data from the salinometer analysis, the position on the rosette that the sample was taken from and a data quality flag number.
- *msal_02*: copies the information from the *sal_jc090_nnn.nc* file to the sample file *sam_jc090_nnn.nc*.

For oxygen samples the following scripts were run:

- *moxy_01*: creates an oxygen sample file (*oxy_jc090_nnn.nc*) to store the results from the oxygen sample analysis. It uses a text file (comma separated) named *oxy_jc090_nnn.csv* which contains data from the oxygen analysis, the position on the rosette that the sample was taken from and a data quality flag. The oxygen analysis was in umol kg^{-1} so no further conversion was necessary.
- *moxy_02*: copies the information from *oxy_jc090_nnn.nc* to the sample file *sam_jc090_nnn.nc*.
- *moxy_03*: maps the upcast oxygen sample to the appropriate place on the downcast using potential density. This is for calibrating the CTD oxygen sensor (see below).
- *moxy_04*: Generates a residuals file for the oxygen concentration measurements and the CTD downcast oxygen based on the mapped positions of the oxygen samples. Creates *oxy_jc090_nnn_oresid.nc*

Processed CTD sensor data was viewed using script *mplotxy_ctdck*. This uses *DCS*, *PSAL* and *2db* CTD files to allow the CTD data to be viewed and compared with data from previous casts. CTD data was viewed as soon as possible after each cast to identify any potential problems with the sensors. No issues with the CTD sensors were found during cruise JC090.

Temperature-Conductivity Sensor first choice

The CTD used on JC090 were equipped with two conductivity sensors each. The primary conductivity-temperature sensor for each frame was attached near the bottom of the frame and the secondary sensor was attached to the fin.

The primary and secondary temperature sensors compared well (mean difference $0.005\text{ }^{\circ}\text{C}$; median $6.5660 \times 10^{-4}\text{ }^{\circ}\text{C}$) for all casts with the difference remaining constant on both

upcast and downcast. Primary and secondary conductivity sensors were also in good agreement (mean difference 0.004 Sm^{-1} ; median $-2.4450 \times 10^{-4} \text{ Sm}^{-1}$) for all casts.

For both frames the primary conductivity-temperature sensor was used as the first choice sensor for all casts.

Salinity Calibration

Upcast salinity from the first choice sensors present in the *SAM* file at bottle depths as *upsal* was calibrated against salinity derived from bottle samples.

Residuals for the bottle – CTD conductivity appeared to be stable over time. Consequently a single calibration of CTD conductivity to bottle conductivity was carried out using all casts. A multiplicative correction factor for the CTD salinity was estimated as the mean ratio of bottle conductivity and CTD conductivity. Conductivities were further corrected using an additive factor calculated from a quadratic fit to bottle – CTD conductivity residuals and pressure. Conductivity calibration was applied to the first choice conductivity sensor in the 24Hz files and the CTD processing re-run.

Oxygen Calibration

Residuals for bottle – CTD oxygen appeared to be stable over time. A multiplicative correction factor for the CTD oxygen was estimated as the mean ratio of the bottle and CTD oxygen values. This factor was calculated using the data from all casts. Oxygen calibration was applied to the oxygen values in the 24Hz files and the CTD processing re-run.

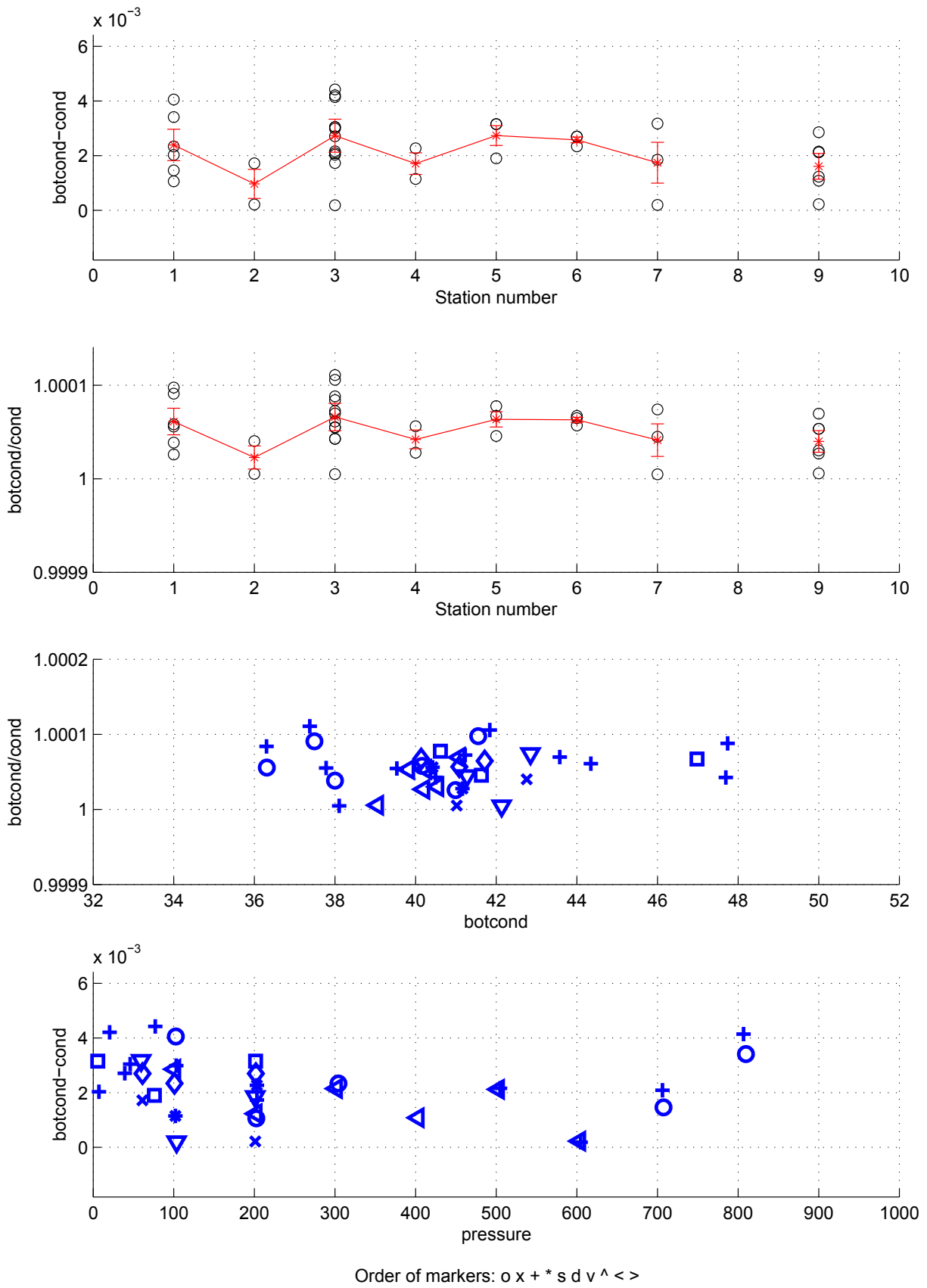

Figure 15: Comparison of bottle conductivity to CTD conductivity prior to calibration.

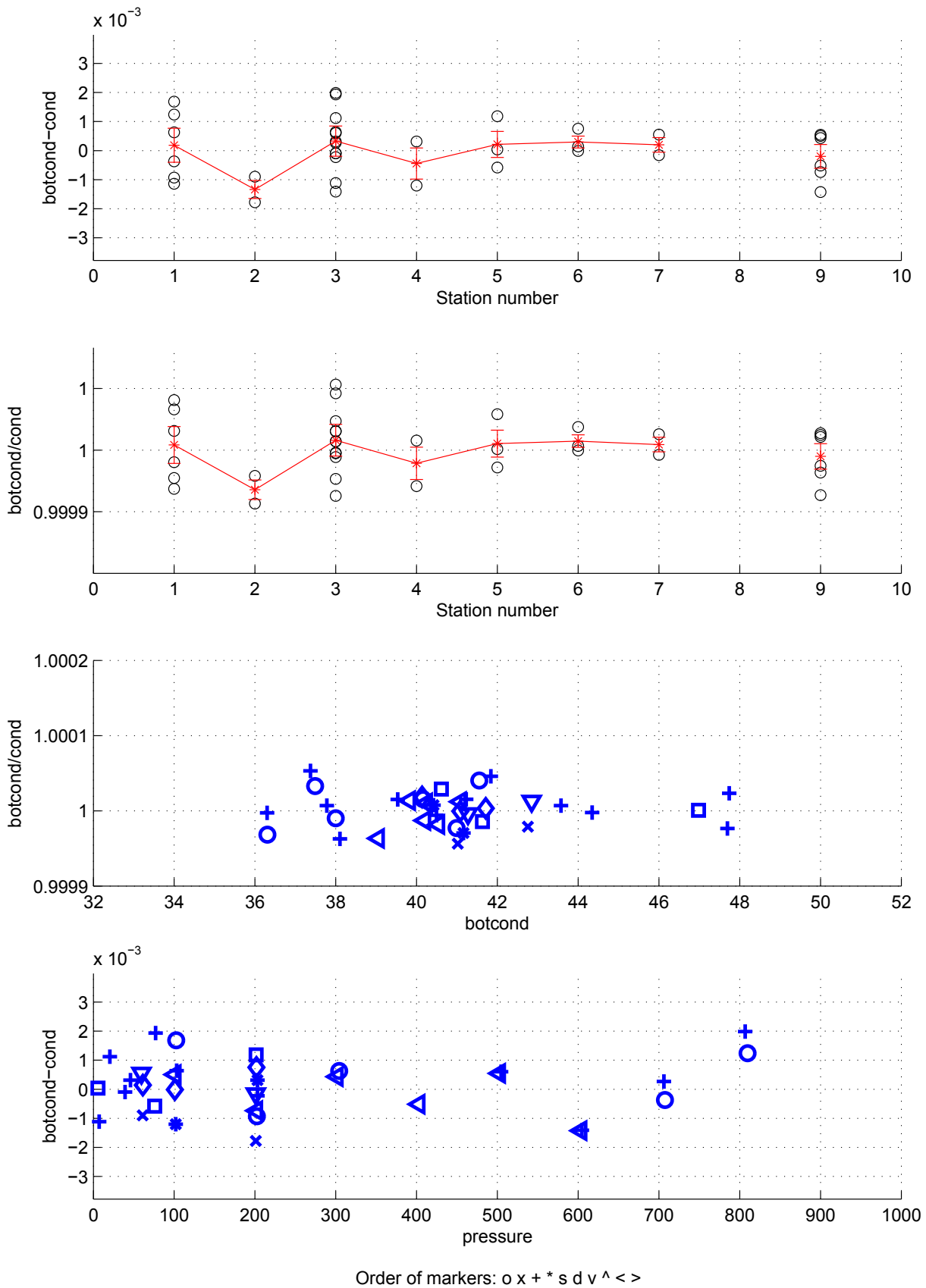

Figure 16: Comparison of bottle conductivity to CTD conductivity post calibration.

Oxygen analysis – *Stephen Woodward*

In order to calibrate the Aanderaa Oxygen optode sensors on seagliders SG533 and SG566, samples were taken from two 1000m CTD casts in proximity to the inner PAP moorings whilst the gliders held position in virtual mooring mode. Opportunistic samples were also taken from a 200m CTD cast intended for calibration of the WetLabs sensor, close to the gliders' positions at the SW outer mooring the night before recovery. The schedule of sampling can be summarised as follows:

Cast	Depth ¹	Lat ²	Lon ²	Date / time on deck	No. Sam- ples	SG533 Lat ³	SG533 Lon ³	SG566 Lat ³	SG566 Lon ³
1	998.04	48° 40.82'	-16° 11.45'	03/09/13 18:05	31	48° 41.21'	-16° 09.52'	48° 41.62'	-16° 11.77'
3	1001.02	48° 40.96'	-16° 09.55'	04/09/13 15:45	34	48° 41.311'	-16° 11.51'	48° 41.71'	-16° 11.80'
5	199.79	48° 38.80'	-16° 15.64'	06/09/13 19:45	15	48° 38.05'	-16° 17.46'	48° 38.35'	-16° 16.22'

¹ The calculated depth of the CTD when the deepest niskin was fired.
² Lat/Lon of the *RRS James Cook* when it deployed the CTD.
³ Lat/Lon at which each seaglider last surfaced prior to recovery of the CTD.

Table 19: Winkler Oxygen sampling schedule

Sampling procedure

125ml borosilicate glass Iodine flasks of known calibrated volumes were rinsed for 30-40 seconds with seawater from the same niskin bottle as sampled. Once rinsed, the flask was gently reoriented and completely filled with an amount of water 2-3 times the flask volume. The excess of water was left to overflow, and the flask was checked for the absence of bubbles. Using Ceramus automatic dispensers, 1.00 cm³ of 3.0 mol dm⁻³ Manganese Chloride Tetrahydrate (MnCl₂) and 1.00 cm³ 4.0 mol dm⁻³ Sodium Iodide/8.0 mol dm⁻³ Sodium Hydroxide (NaOH/NaI) were added to fix the oxygen. Flasks were subsequently sealed with the corresponding stopper and vigorously shaken to mix the reagents with the sample. The shaking was repeated after 20-30 minutes, and the flasks were left overnight to let the precipitate settle. All samples were taken in duplicate or triplicate. The temperature was recorded at the time of sampling using a handheld digital temperature probe.

Instrumental analysis

Analysis was performed in the controlled environment lab of *RRS James Cook*, with the room temperature set to 20° C.

The stopper was removed from each sample flask and 1.00 cm³ of 5.0 mol dm⁻³ Sulphuric acid (H₂SO₄) was added to the sample together with a magnetic stir bar. The titra-

tion was performed with 0.20 mol dm^{-3} Sodium Thiosulphate Pentahydrate ($\text{Na}_2\text{S}_2\text{O}_3$) after most of the precipitate has dissolved, liberating Iodine until the equivalence point was reached. Burettes were flushed before each titration to remove bubbles for at least 5 minutes (10 minutes when first unpacked). Two 'junk' samples consisting of fixed tap water were titrated prior to the analysis of each batch of samples, and a further 'junk' was titrated after each pause in the sequence of analysis. The temperature was recorded at the time of titration using a handheld digital temperature probe.

Sodium Thiosulphate standardisation was performed six times during the cruise. In this case MilliQ water was poured into an Iodine flask with a magnetic stirring bar. Then reagents were added in the order of 1.000 cm^3 of 'standard' $23.36 \text{ mol dm}^{-3}$ Potassium Iodide (KIO_3) solution by Metrohm Dosimat, 1.00 cm^3 of H_2SO_4 5 mol dm^{-1} , 1.00 cm^3 of NaOH/NaI and 1.00 cm^3 of MnCl_2 . Flasks were then filled to the neck with MilliQ. The resulting solution was titrated to the equivalence point with $\text{Na}_2\text{S}_2\text{O}_3$ by Metrohm Dosimat and final volume of titrant added was recorded. The temperature was recorded at the time of KIO_3 addition and titration using a handheld digital temperature probe. On two occasions (02/09/2013 and 06/09/2013) standardisation of the KIO_3 solution was compared to that of a previously used solution from research cruise JC085.

Blank determination was performed five times during the cruise. MilliQ water was poured into an Iodine flask, together with a magnetic stir bar. 0.100 cm^3 of 'blank' KIO_3 solution (by pipette), 1.00 cm^3 of H_2SO_4 5 mol dm^{-1} , 1.00 cm^3 of NaOH/NaI and 1.00 cm^3 of MnCl_2 were then added. Flasks were then filled to the neck with MilliQ water, and the resulting solution was titrated to the equivalence point with $\text{Na}_2\text{S}_2\text{O}_3$ and final volume of titrant added was recorded. An additional 0.100 cm^3 of 'blank' KIO_3 was added to the solution by pipette and the titration was repeated. Blank volume was measured as the difference between the first and second $\text{Na}_2\text{S}_2\text{O}_3$ titrant volume. The temperature was recorded at the time of KIO_3 addition using a handheld digital temperature probe.

Problems encountered

Difficulties arose when initially setting up the automated Winkler titration system. The inbuilt magnetic stirrer failed to turn, and upon closer inspection by Paul Damerell (ship's ETO), no voltage was found on the live wire between PCB and stirrer motor. Following removal of a small patch of corrosion on the PCB, power was restored. After reconnecting all cables, a loose connection was noted on the PCB connector. If properly seated, the stirrer motor received no power, but, if loosened too much, signal output from detector to PC was lost. A careful balance of this connector position was required for correct operation of the unit. The system performed well for the duration of the cruise once this problem was addressed, but this issue should be noted for attention before future use - cable position shifting during sample analysis in rough weather would cause loss of data.

Results

Although calibrations will be carried out at a later date, initial results are within expected tolerances. Table 20 shows standard precision over the course of JC090 (target precision for this analytical method is 0.05-0.1%). Figure 17 shows the offset between Oxygen results from the SeaBird SBE43 optode sensor on the CTD package and those from the Winkler system. All samples analysed are included in this comparison.

Date	c(S ₂ O ₃ ²⁻) mmol l ⁻¹	sd(S ₂ O ₃ ²⁻) mmol l ⁻¹	Precision
02/09/2013	0.2016	0.0003	0.16%
03/09/2013	0.2014	0.0001	0.03%
04/09/2013	0.2012	0.0000	0.01%
05/09/2013	0.2015	0.0000	0.02%
06/09/2013	0.2015	0.0002	0.11%
08/09/2013	0.2014	0.0001	0.03%

Table 20: Winkler Oxygen standard precision

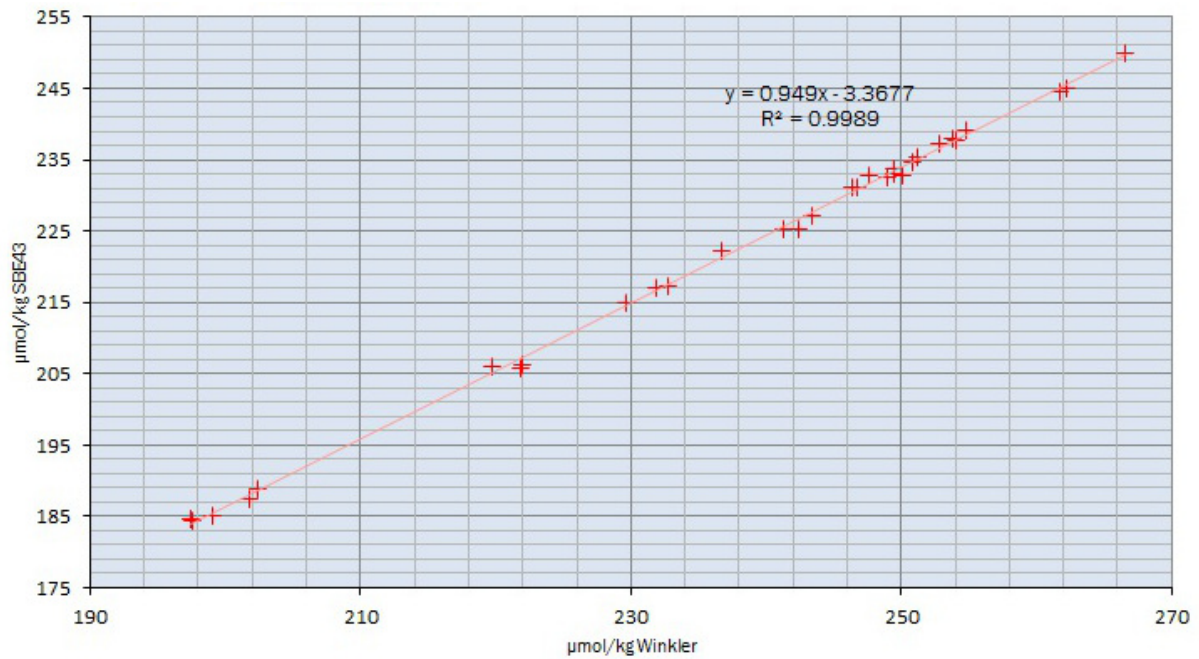

Figure 17: SBE43 Winkler Oxygen offset.

Chlorophyll-a, Inorganic Nutrients, Particulate Organic Carbon/Nitrogen (POC/PON), Scanning Electron Microscope (SEM) filters, Particulate Inorganic Carbon (PIC) and Biogenic Silica (BSi) – *Anna Rumyantseva, Emily Trill, David Marshall, Madeleine Youngs*

Objectives

1. Calibrate Wetlabs fluorescence and particulate optical backscatter sensors on the OSMOSIS Seagliders SG533 and SG566
2. Calibrate fluorescence sensor on the turbulence probe MSS050
3. Study autumn phytoplankton bloom at the Porcupine Abyssal Plain site and sub-surface chlorophyll maxima evolution
4. Evaluate relationship between phytoplankton species composition, nutrients concentration and turbulence

Methods

A CTD rosette was used for collecting water samples from various depths between the surface and 200 m (Table 21). The rosette had 24 Niskin bottles with 20 litre capacity. Samples from the ships underway (≈ 5 m depth) for chlorophyll, salinity and nutrient analysis were taken approximately every 6 hours from 1100 (GMT) on 02/09/2013 (J245) to 1700 (GMT) on 13/09/2013 (J256).

Onboard analysis was conducted for chlorophyll samples only. All other samples were taken to a freezer for later analysis in the National Oceanography Center, Southampton.

Chlorophyll-a

Requires: 250-ml brown sampling bottles (SAMPLING), GF/F filters, 10 μ m polycarbonate filters (FILTERING), 20-ml Glass vials, numbered, 90% acetone, fridge (EXTRACTION), Trilogy Fluorometer, small glass vials (MEASUREMENT).

Sampling: Chlorophyll-a samples were taken from Niskin bottles which were fired at depths between 100 m and surface and the ships underway. Water samples collected were always analyzed for estimation of total chlorophyll concentration and community size fractionation. Size fractionation of chlorophyll sample was conducted in order to determine ratio between microphytoplankton ($> 10 \mu$ m) and pico- and nano phytoplankton ($< 10 \mu$ m).

$> 10 \mu$ m Chl-a: Place 25 mm 10 μ m polycarbonate filter into a filtration unit and connect to the receiver flask. 250 ml of seawater is measured out using a measuring cylinder and poured into the filtration unit. Gently remove the polycarbonate filter, fold slightly and place sample side up in the bottom of sequentially numbered 20 ml glass vial, add 8 ml of 90% acetone and leave in fridge for 18-20 hours. Gently shake to open the filter once in the acetone.

<10 um Chl-a: Collect the filtrate from receiver flask and filter through a 25 mm GF/F filter using the 6-port filtration rig. Gently remove the filter and place sample side up in the bottom of sequential numbered 20 ml glass vial, add 8 ml of 90% acetone and leave in fridge for 18-20 hours.

Total Chl-a (core): Place a 25mm MF300 filter in 6-port Chl rig. Measure out 250 mm of sea water and filter under gentle vacuum. Remove filter and place in 20 ml glass vial, add 8 ml of 90% acetone and leave in a fridge (4°C) for 18-20 hours in a dark box.

After 18-20 hours of refrigeration, the chlorophyll samples were analysed with a fluorometer.

To read fluorescence from samples: First measure a solid standard, then an Acetone blank, note on a logsheet. Then sequentially pour each sample from 20ml vial into 5ml glass fluorometer vial (so as to cover the aperture), place in fluorometer, close lid, scan and read fluorescence. Pour waste acetone into 1L waste container, including filters. Wash vials with MilliQ and leave to air dry before use.

Inorganic nutrients

10 ml of water sample collected for nutrient analysis in a 15ml labeled (cruise number, CTD number, date, Niskin bottle number, depth) centrifuge tube.

Particulate organic carbon / nitrogen (POC/N)

0.5 L of seawater sample was filtered through precombusted (400°C, 12 hours) GF/F filter. Then few drops of 1% HCl were added to filter and rinsed off with pH-adjusted MilliQ. Filters were placed in labeled cryovials (cruise number, CTD number, date, Niskin bottle number, depth and volume) and left to air dry with lids opened.

Scanning Electron Microscope (SEM) filters

0.5 L of seawater sample was filtered through 0.8 um polycarbonate filters. Afterwards filters were rinsed with pH-adjusted MilliQ water, removed to Petri slides and left to air dry with lids opened.

Biogenic Silica (BSi)

0.5 L of seawater sample was filtered through 0.8 um polycarbonate filters. Afterwards filters were rinsed with pH-adjusted MilliQ water, placed in labeled Falcon tubes (cruise number, CTD number, date, Niskin bottle number, depth and volume) and left to air dry with lids opened.

Particulate Inorganic Carbon (PIC)

0.5 L of seawater sample was filtered through 0.8 um polycarbonate filters. Afterwards filters were rinsed with pH-adjusted MilliQ water, placed in labeled Falcon tubes (cruise number, CTD number, date, Niskin bottle number, depth and volume) and left to air dry with lids opened.

CTD cast	Depth	Chl-a	Chl-a size fract.	POC	SEM	PIC	BSi	Nut.	Comments
1	5	x	x	x	x			x	
	20	x	x	x				x	
	34	x	x	x	x			x	Chl maximum
	47	x	x	x	x			x	Oxygen minimum
	75	x	x	x				x	
	100	x		x				x	
	200							x	
2	5	x	x	x		x	x	x	
	10	x						x	
	20	x	x	x		x	x	x	
	30	x	x	x		x	x	x	
	42	x	x	x		x	x	x	Chl maximum
	50	x	x	x		x	x	x	
	60	x	x					x	
	75	x		x		x	x	x	
	100	x						x	
	150							x	
	200							x	
3	5	x	x	x	x	x	x	x	
	20	x	x	x		x	x	x	
	30	x	x	x		x	x	x	
	38	x	x	x	x	x	x	x	Chl maximum
	45	x	x	x	x	x	x	x	
	75	x	x	x		x	x	x	
	100							x	
	200							x	
4	5	x		x		x	x	x	
	10	x						x	
	20	x		x		x	x	x	
	30	x		x		x	x	x	
	39	x		x		x	x	x	Chl maximum
	45	x		x		x	x	x	
	60	x						x	
	75	x		x		x	x	x	
	100	x						x	
	150							x	
5	5	x	x	x	x	x	x	x	

Continued on next page

Table 21 – *continued from previous page*

CTD cast	Depth	Chl-a	Chl-a size fract.	POC	SEM	PIC	BSi	Nut.	Comments
	10	x		x		x	x	x	POC filter cup leaked
	20	x	x	x		x	x	x	
	31	x	x	x	x	x	x	x	Chl maximum
	47	x	x	x	x	x	x	x	Chl thin layer
	75	x		x		x	x	x	
	100							x	
	200							x	
6	5	x	x	x	x	x	x	x	
	10	x		x		x	x	x	
	20	x	x	x	x	x	x	x	
	30	x	x	x	x	x	x	x	Chl maximum
	60	x	x	x		x	x	x	
	75	x		x		x	x	x	
	100							x	
	150							x	
	200							x	
7	5	x	x	x	x	x	x	x	
	20	x	x	x		x	x	x	
	30	x	x	x	x	x	x	x	
	42	x	x	x	x	x	x	x	Chl maximum
	60	x	x	x		x	x	x	
	75	x		x		x	x	x	
	100							x	
	150							x	
	200							x	
8	5	x	x	x	x	x	x	x	
	20	x	x	x		x	x	x	
	40	x	x	x	x	x	x	x	
	51	x	x	x	x	x	x	x	Chl maximum
	60	x	x	x		x	x	x	
	75	x		x		x	x	x	
	100							x	
	150							x	
	200							x	

Table 21: Samples taken from Niskin bottles

Preliminary results

Pronounced subsurface chlorophyll maximum was present at the sampling site during the cruise, ranging between ~ 30 and 40 m. Size fractionation showed that phytoplankton community was dominated by nano- and picophytoplankton (Figure 18). Succession of small phytoplankton by microphytoplankton in the mixed layer was observed during CTD cast 5. Subsequent analysis of SEM samples will be used to confirm that succession took place.

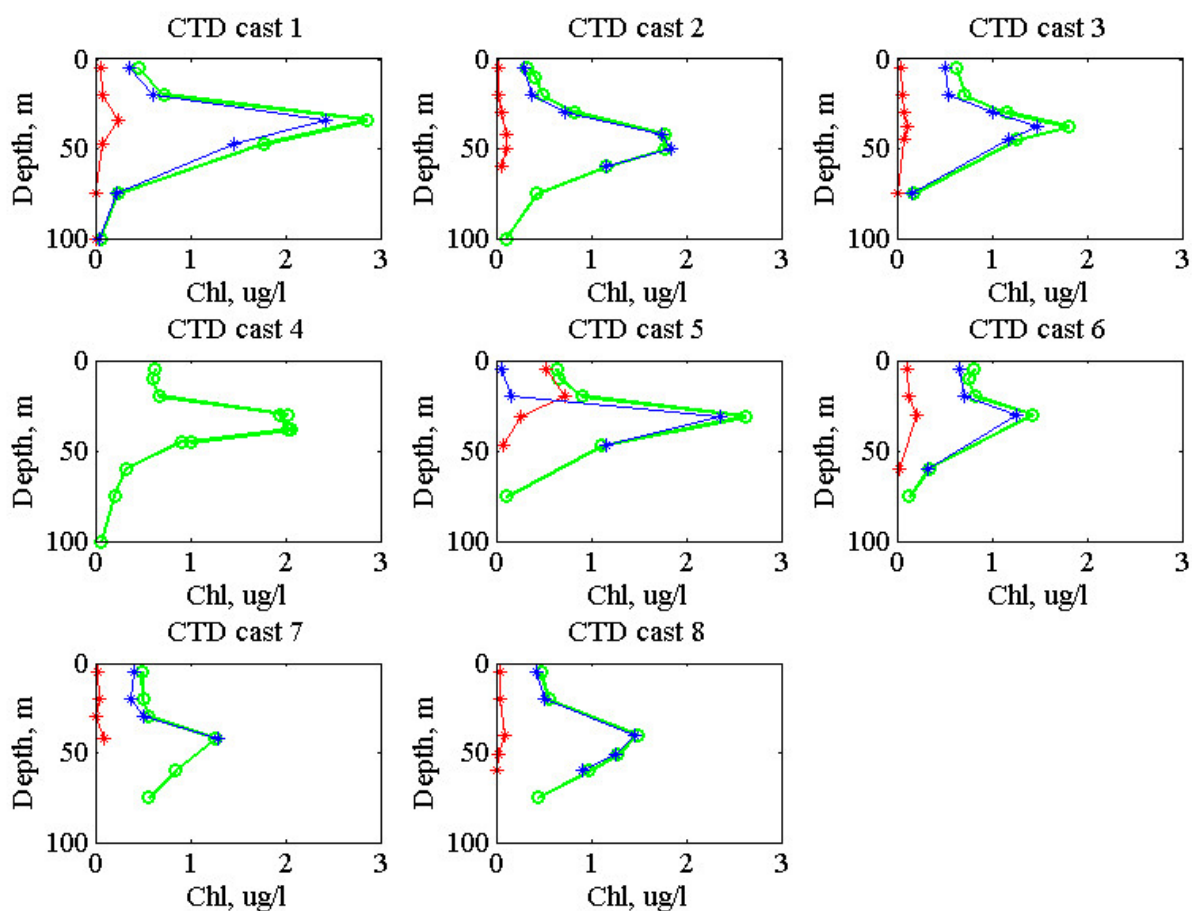

Figure 18: Onboard analysis of vertical distribution of total chlorophyll (green line), > 10 μm (red line), < 10 μm (blue line).

Analysis of samples from the ships underway system showed that surface chlorophyll concentrations were ranging between $0.4 - 1.10$ $\mu\text{g/l}$ (Figure 19). Also significant spatial variability in surface chlorophyll distribution was observed over the sampling area associated with presence of a front (Figure 20).

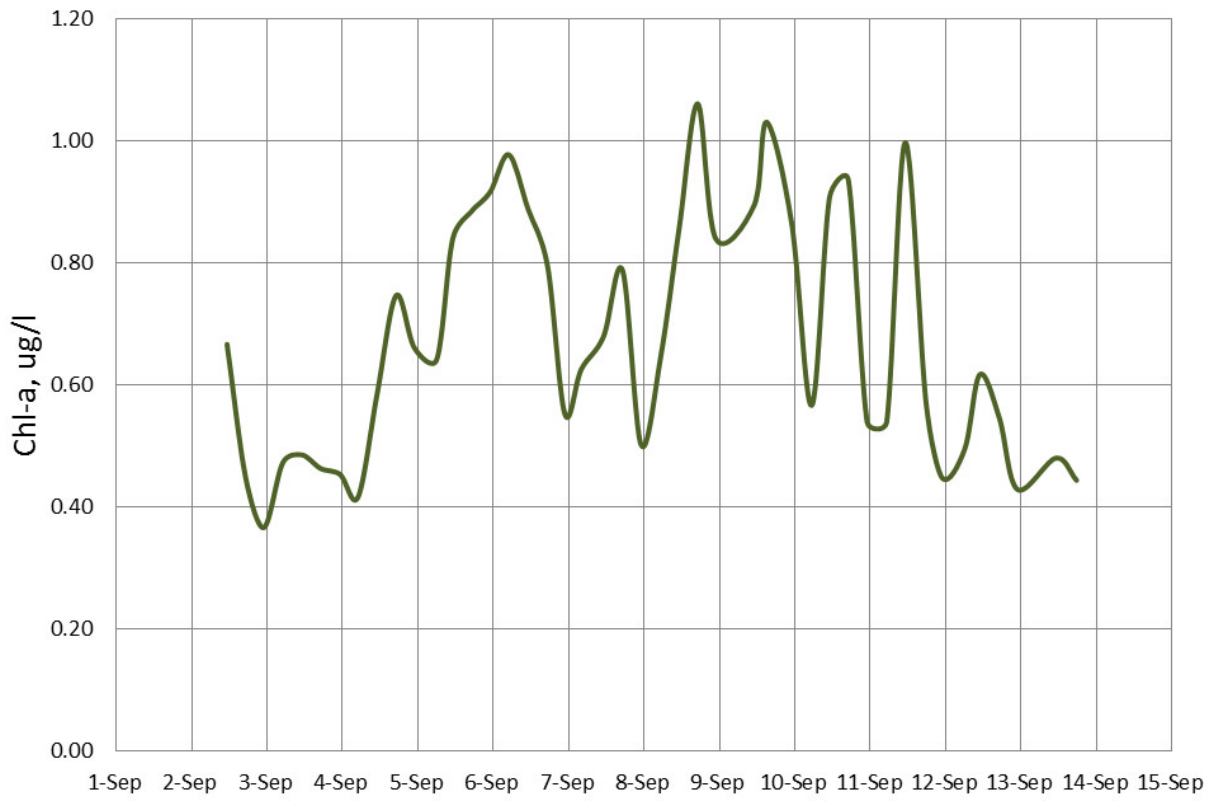

Figure 19: Time series of underway chlorophyll concentration.

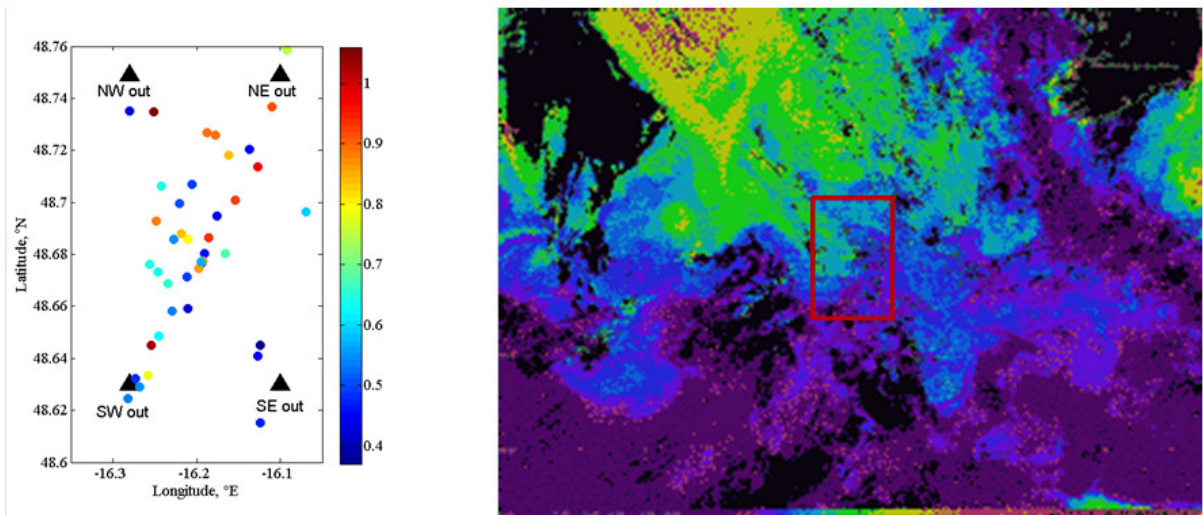

Figure 20: Spatial distribution of underway chlorophyll concentration (ug/l) (left). Remote sensing image of surface chlorophyll concentration provided by PML 7 day composite 6 – 12 September 2013 (right)

Lowered Acoustic Doppler Current Profiler (LADCP) – *Alex. Forryan*

Instruments Setup and Performance

One RDI 300kHz Workhorse LADCP unit was fitted to the CTD frame used on cruise JC090 in a downward-looking orientation and used for all casts. The copy of the command file used is included Section 3 TRDI LADCP Configuration.

Data Processing

The data collected by the instrument were downloaded after each cast and stored as RDI binary files and corresponding text files.

The data were then processed using the latest version of the software from Lamont-Doherty Earth Observatory (LDEO). This calculates velocities using an inverse method. The *set_cast_params.m* script which sets up the parameters and file paths for the processing is given below.

Set_cast_params.m

```
% Simple matlab script to read in
% station time and position data in preparation for
% LDEO ladcp2 processing. Also sets paths to data.

% set cruise_str
cruise_str = 'D381';

%temporary set for batch runs
run_letter = 'wctd';

% get station number and pad it
if(exist('stn') ~= 1)
    stn = input('    Type station number: ');
end
% put zeroes in front of statnum
stnstr = sprintf('%03d',stn);

if (exist('first_time') ~=1)
    disp(' ')
    disp(['##### ' 'Processing ' cruise_str ...
        ' station ' stnstr ' #####']);
end

% get run letter
if(exist('run_letter') ~= 1)
    run_letter = input('Type run letter: ','s');
end
```

```

if (exist('first_time') ~=1)
    disp(' ')
    first_time = 1;
end

%%%%%%%%%%%% F Values
% paths to BB dataa
% downloader
f.ladcpdo = ['./LADCP/D381_',stnstr,'.000'];
% uploader
f.ladcpup = [''];
% f.ladcpup = ['./ladcp/jc068_',stnstr,'s.000'];

f.nav = './NAV/sm_ldeoIX.asc';
% f.nav_time_base = 1; %yeardays
f.nav_time_base = 2; %Visbeck julian
f.nav_header_lines = 0;
f.nav_fields_per_line = 3;
f.nav_time_field = 1;
f.nav_lat_field = 3;
f.nav_lon_field = 2;

f.res = ['./' cruise_str stnstr '/' cruise_str stnstr run_letter ];

if exist([cruise_str stnstr],'file') ~= 7
    eval(['!mkdir ' cruise_str stnstr ])
end

% ctd time series file
f.ctd = ['./CTD/D381_' stnstr '_ctm_wild_bin.asc'];

f.ctd_time_base = 0;%elapsed time
f.ctd_header_lines = 1;
f.ctd_fields_per_line = 4;
f.ctd_time_field = 4;
f.ctd_pressure_field = 1;
f.ctd_temperature_field = 3;
f.ctd_salinity_field = 2;

% checkpoints
f.checkpoints = ['./checkpoints/' cruise_str stnstr run_letter ];

% vmadcp data

```

```

% this is converted from MSTAR Combined VMADCP record
% vmadcp on jc is pretty much uniformly rubbish as the wetaher is bad
f.sadcp = ['./VMADCP/d381_vmadcp75.mat'];

%%%%%% P parameters
p.name = [cruise_str stnstr run_letter ];
p.ladcp_cast = stn;
p.cruise_id = cruise_str;
p.whoami = 'A. Forryan';
%p.saveplot = [1:6 9:11 13:14];
p.ladcp_station = stn;

%p.edit_mask_dn_bins = [1];
%p.edit_mask_up_bins = [1];

% remove all bins > 5 (titanium frame)
%p.edit_mask_dn_bins = [1 32:1:64];
%p.edit_mask_up_bins = [1 32:1:64];

% set magnetic deviation
fname = [ 'POSTIMES/postime' stnstr];
postime = load(fname);
autocat = 1;
intlcat = postime(4);
intlcat = postime(6);
p.drot = magdev(intlcat,intlcat);

%level of debugging
p.debug = 1;

% says it all really - just for fun
pk.top='calculate vertical diffusion';

% desired vertical range over which to compute spectrum
pk=setdefv(pk,'zrange',500);

% number of grid points to slide down
pk.kz_ioff = 5;

% use also shearbased profile if available
pk.use_shear = 1;

% this doesnt do anything unless you're in beam coordinates
% disp(' ');
% disp(['##### ATTENTION SET TO IGNORE BEAM 2 IF IN BEAM COORDINATES #####']);
% disp(' ');

```

```

% p=setdefv(p,'ignore_beam',[2 2]);
% p=setdefv(p,'allow_3beam_solutions',1);
%%%%%%%%%%%%%%%%%%%%%%%%%%%%%%%%%%%%%%%%%%%%%%%%%%%%%%%%%%%%%%%%%%%%%%%%
% mostly copied from default.m

% how to get depth from W integration
% getdepth=1 use plain integral of W (mfile getdpth)
% getdepth=2 use inverse method to use bottom reflection
% and integral of W (mfile getdpthi) [default]
% NB (IX_6): based on a single profile that I've processed,
%   as well as on comments by Gerd & Martin,
%   it may well be that getdepth=1 works better
%   with shallow stations
p.getdepth = 2;

% navigation error in m
p.nav_error = 30;
% average navigation from nav file over a certain fraction of days (2 minutes)
p.navtime_av = 2/60/24;

% p.avdz sets the depth interval between adjacent super-ensembles
% default one bin length
% p=setdefv(p,'avdz',medianan(abs(diff(d.izm(:,1))))));

% p.avens overridden p.avdz and sets a fixed number of ensembles to average
% default NAN not used
% NB (IX_6): When p.avens == 1, p.single_ping_accuracy has to be set!
%   Otherwise, the software cannot determine the weight of the
%   BT constraint.
% p=setdefv(p,'avens',NaN);

% BOTTOM TRACK
% The are several options to get bottom track data
%
% mode = 1 :   use only RDI bottom track
%           2 :   use only own bottom track
%           3 :   use RDI, if existent, own else (default)
%           0 :   use not bottom track at all
p.btrk_mode = 3;

% p.btrk_ts is in dB to detect bottom above bin1 level (for own btm track)
p.btrk_ts = 10;

% p.btrk_below gives binoffset used below target strength maximum
% to make bottom track velocity
p.btrk_below = 1;

```

```

% p.btrk_range gives mininum / maximum distance for bottom track
p.btrk_range = [300 50];

% p.btrk_wstd gives maximum accepted wstd for super ensemble averages
p.btrk_wstd = 0.1;

% maximum allowed difference between reference layer W and W bottom track
p.btrk_wlim = 0.05;

% force to recalculate bottom distance using target strenght
p=setdefv(p,'bottomdist',0);

%Write matlab file
p.savemat = 1;

% produce much more RAW data output
% set to 1 for more data
p.orig = 1;

% save individual target strength
p.ts_save=[1 2 3 4];
% p=setdefv(p,'ts_save',0);
% save individual correlation
p.cm_save=[1 2 3 4];
% p=setdefv(p,'cm_save',0);
% save individual percent good pings
p.pg_save=[1 2 3 4];
% p=setdefv(p,'pg_save',0);

%%%%%%%%%%%%%%%%%%%%%%%%%%%%%%%%%%%%%%%%%%%%%%%%%%%%%%%%%%%%%%%%%%%%%%%%
% Parameter for inversion    ps.* structure

% Process data using shear based method
% compute shear based solution
% ps.shear=2 ; use super ensemble
% ps.shear=1 ; use raw data
ps.shear=1;

% decide how to weight data
% 1 : use super ensemble std
% 0 : use correlation based field
ps.std_weight = 1;

% Weight for the barotropic constraint
% ps=setdefv(ps,'barofac',1);

```

```

% Weight for the bottom track constraint
% ps=setdefv(ps,'botfac',1);

% Process up and down cast seperately
% ps=setdefv(ps,'down_up',1);

% Depth resolution for final profile
% default one bin length
% ps=setdefv(ps,'dz',medianan(abs(diff(di.izm(:,1)))));

% Smoothing of the final profile
% ps=setdefv(ps,'smoofac',0.01);

% comment this out to request that shears are small (experts only)
ps.smallfac = [1 0];

% weight bottom track data with distance of bottom
% use Gaussian with offset (btrk_weight_nblen(1) * bin)
% and width (btrk_weight_nblen(2) * bin)
% one might set this to [15 5] to reduce the weight of close by bottom track data
ps.btrk_weight_nblen = [0 0];

% Weight for SADCPC data
% ps.sadcpfac=1 about equal weight for SDACP profile
ps.sadcpfac = 3;

% average over data within how many standart deviations
ps.shear_stdf = 2;

% the minimum weight a bin must have to be accepted for shear
% ps.shear_weightmin = 0.1;

% restrict inversion to one instrument only 1: up+dn, 2:dn only 3:up only
%ps=setdefv(ps,'up_dn_looker',1);

% super ensemble velocity error
% try to use the scatter in W to get an idea of the "noise"
% in the velocity measurement
% This is a bit of code used in GETINV.m
% nmax=min(length(di.izd),7);
% sw=stdnan(di.rw(di.izd(1:nmax),:)); ii=find(sw>0);
% sw=medianan(sw(ii))/tan(p.beamangle*pi/180);
% ps=setdefv(ps,'velerr',max([sw,0.02]));
%
% ps=setdefv(ps,'velerr',0.02);

```

```

% How to solve the inverse
%   ps.solve = 0  Cholseky transform
%               = 1 Moore Penrose Inverse give error for solution
% ps=setdefv(ps,'solve',1);

% Threshold for minimum weight, data with smaller weights
% will be ignored
p.weightmin = 0.05;

% Change the weights by
% weight=weight^ps.weightpower
% ps=setdefv(ps,'weightpower',1);

% Change remove 1% of outlier after solve
% ps.outlier times
ps.outlier = 1;

% set ps.down_up=1 if up/down cast should be solved seperately
% ps=setdefv(ps,'down_up',1);setdefv(ps,'weightpower',1);

% Weight for the cable drag constraint
% only for experts
% ps=setdefv(ps,'dragfac',0);
% ps=setdefv(ps,'drag_tilt_vel',15);
% ps=setdefv(ps,'drag_lagmax',15);
% ps=setdefv(ps,'drag_zmax',2000);

% Set fixed range for velocity plots
% ps=setdefv(ps,'urange',ur);
% ps=setdefv(ps,'zrange',ax(3:4));

%vertical resolution (m)
% ps.dz = 10;
% ps.dz = 4; % D381 data resolution
ps.dz = 8;
%for compatability with hawaii method (need for ping data)
%ps.dz = 20;

%%%%%%%%%%%%
% Some params from Brian
% p.ladcp_station= 4;
% p.drot is now calculated later from position picked out of f.nav
% p.drot=magdev(p.poss(1)+p.poss(2)/60, p.poss(3)+p.poss(4)/60);
% p.btrk_mode = 2; %Polarstern 23/7 set btrk = 2 and use cd171 version of loadrdi. Th

```

```
% precentage good threshold
% set to arbitrary value
%p.pglim=0;

%p.elim=0.2;
%p.wlim=0.08;
%p.avdz=ps.dz;
% BAK at SOC 27 Jan 2003; Should set ps.dz to be ladcp bin size.
%ps.dz=10;
%ps.down_up=1;
%ps.botfac = 0;
%ps.barofac = 1;
%ps.shear = 0;
%ps.dragfac = 0;

clear pk
```

Continuous Measurements of Atmospheric O₂ and CO₂ – *Penelope Pickers and Andrew Manning*

Background

The accumulation of carbon dioxide (CO₂) in the atmosphere from fossil fuel burning and land use change is known to be partially mitigated by two global CO₂ sinks: the land and the oceans. Although the total global CO₂ sink is relatively well constrained, the partitioning of this global sink into the land and ocean remains uncertain. Concurrent measurements of atmospheric oxygen (O₂) and CO₂ can be used to separate out land and oceanic fluxes of CO₂, because land exchanges of CO₂ and O₂ are largely coupled, whereas oceanic exchanges of CO₂ and O₂ are generally de-coupled, owing to differences in the chemical and physical interactions of CO₂ and O₂ in seawater. Similarly, atmospheric measurements can also exploit the geochemical differences between the behaviours of CO₂ and O₂ in seawater to separate the oceanic influences of marine productivity, mixing, and temperature and salinity induced solubility changes on atmospheric concentrations. Improving scientific understanding of such oceanic processes and the potential feedbacks that may enhance or attenuate future climate change are crucial, since the oceans are most likely the only major long-term sink for anthropogenic CO₂ emissions.

The use of concurrent atmospheric O₂ and CO₂ measurements in atmospheric and biogeochemical models is currently constrained by a low spatial resolution of data; there are many gaps in the global atmospheric CO₂ and O₂ observational networks, particularly in oceanic regions where making such high precision measurements is extremely challenging. We aim to help address this deficiency by establishing a new in situ automated atmospheric O₂ and CO₂ measurement system that will be installed on a Maersk Line commercial ship, the *Lars Maersk* (see Figure 21), which travels continuously between Bremerhaven, Germany (53°N) and Durban, South Africa (34°S) on an approximately 55 day cycle. This will enable us to collect atmospheric O₂ and CO₂ data over the Atlantic Ocean spanning a wide latitudinal range and at sufficient temporal frequency to define seasonal cycles. These data will be used to gain insight into oceanic influences on atmospheric O₂ and CO₂, including quantifying latitudinal atmospheric O₂ and CO₂ gradients, and examining equatorial oceanic O₂ outgassing and potential changes to the Atlantic carbon sink.

Motivation for joining the JC090 cruise

In order to be installed successfully on the *Lars Maersk*, our measurement system must be almost entirely automated and able to run independent of any human intervention, since we will not be allowed on board the ship once it leaves port, and thus will not be able to make adjustments or carry out maintenance tasks until the ship returns 55 days later. Our motivation for joining the *RRS James Cook* on this cruise was to test our equipment at sea on a research vessel, prior to installation on the commercial ship, thus enabling us to learn the potential weaknesses in the measurement system, and how we might make improvements or upgrades in order to mitigate any such problems from occurring in the future.



Figure 21: Photograph of the Lars Maersk container ship, on which we intend to install our atmospheric O₂ and CO₂ measurement system.

Description of measurement system

The measurement system consisted of two aspirated air inlets (Figure 22) with $\frac{1}{2}$ " OD Synflex tubing that lead into the Meteorological Laboratory on the Boat Deck, where the rest of our equipment was located. Aspirated inlets are required since without these, O₂ is liable to fractionate with respect to N₂ at the point where air enters the Synflex tubing. We installed one inlet on the foremast (referred to as the ‘blue line’) to avoid sampling possibly contaminated air from the ship’s exhaust stack (located just behind the bridge). We were, however, curious to learn whether an inlet mounted closer to the exhaust stack would receive significantly more contaminated air; hence we placed our second inlet on the front of the monkey island directly above the bridge (referred to as the ‘red line’). We then planned to sample air from both inlets, switching between the two lines every 30 minutes.



Figure 22: Photographs of the aspirated air inlets on the monkey island (left) and the foremast (right).

The measurement system consists of a ‘drying unit’, which houses most of the gas handling and the drying components, and a ‘measurement unit’, which houses the O₂ and CO₂ analysers and electronics (see Figures 23 and 24). The gas handling system maintains very stable pressures and flow rates throughout, which is crucial to achieving high accuracy and precision. Before passing through the analysers, the sample air is dried in three stages to reduce the water content of the airstream to less than 1 ppm, or a dew point of about -90°C. The first stage is a thermoelectric cooler set to approximately 3°C, known as a ‘Tropicool’. The second stage is a cryogenic cooler with an ethanol bath set at approximately -50°C, and the third stage is a magnesium perchlorate trap. In other atmospheric O₂ and CO₂ systems, a different cryogenic cooler is typically used, with an ethanol bath at -90°C, thus negating the need for a third stage of drying. However, for our shipboard system, we have been motivated to reduce size and weight wherever possible, and the warmer cryogenic cooler that we employ is exactly half the size and weight of the -90°C cooler, saving about 25 kg in total.

The sample air is measured using an ‘Oxzilla II’ lead fuel cell O₂ analyser (Sable Systems International Inc.) in series with a non-dispersive infrared (NDIR) ‘Li-6252’ CO₂ analyser (Li-Cor Inc.). The O₂ and CO₂ mole fractions of the sample air are measured as differences from a cylinder of air with known mole fraction, known as a ‘working tank’, by passing the sample air through one side of the analysers (sample cell) and simultaneously passing working tank air through the other side (reference cell).

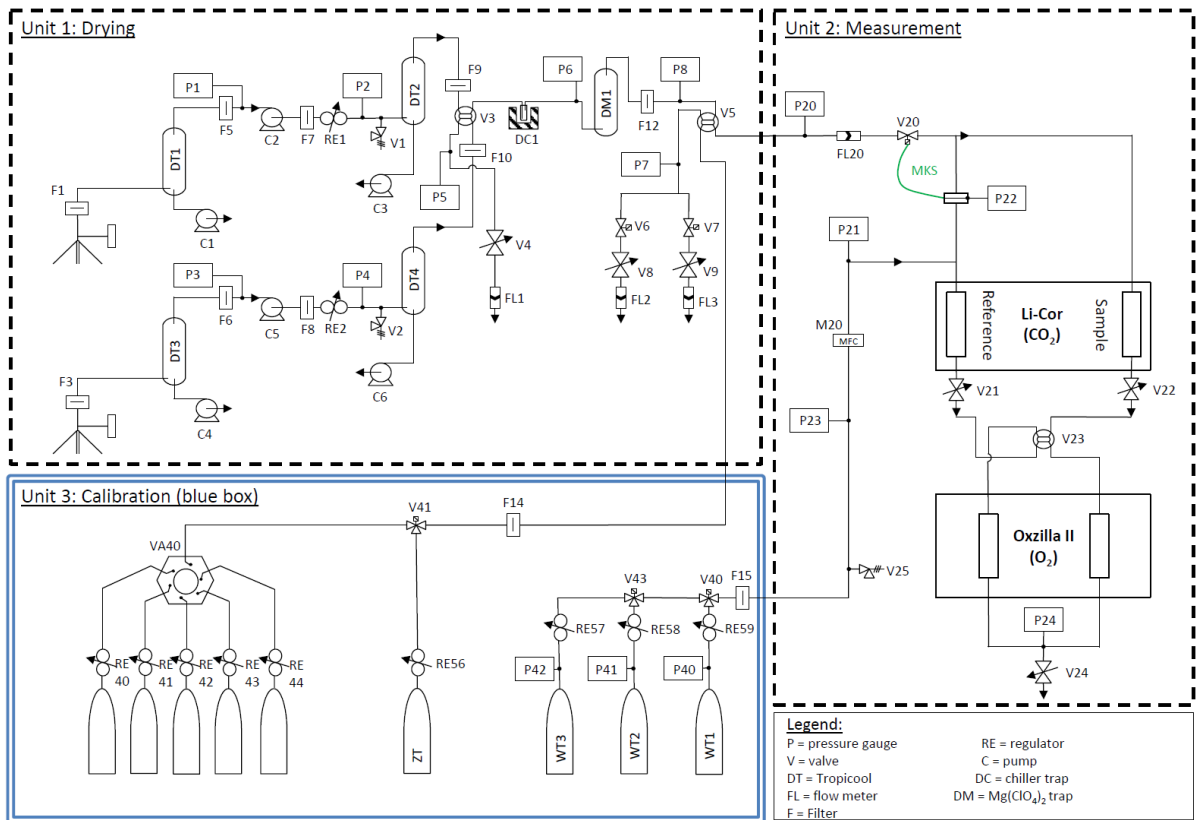

Figure 23: Schematic diagram of the atmospheric O₂ and CO₂ system, comprising of three units: drying, measurement and calibration.



Figure 24: Photograph of the drying unit (left rack) and the measurement unit (right rack). Calibration procedures

The measurements were calibrated rigorously using a suite of calibration cylinders containing air at high pressure, that are stored horizontally in a thermally insulated enclosure, called a ‘Blue Box’ (Figure 25), to reduce thermal and gravitational fractionation effects. Every 23 hours, the analysers’ responses were characterised using four ‘Working Secondary Standard’ (WSS) cylinders that are tied to the World Meteorological Organization (WMO) CO₂ calibration scale (maintained by the National Oceanic and Atmospheric Administration (NOAA), U.S.A.) and the Scripps Institution of Oceanography, U.S.A. calibration scale for O₂. A ‘Zero Tank’ (ZT) cylinder was also analysed every 3 hours to correct short-term drift in the CO₂ analyser’s response, while precision and accuracy were quantified every 7 hours by analysing a ‘Target Tank’ (TT) cylinder with predetermined CO₂ and O₂ mole fraction.



Figure 25: Photograph of the cylinder Blue Box, showing three 10L working tank cylinders (top row) and six 20L cylinders used for calibrating the system.

Software

Our system is controlled using sophisticated bespoke software called ‘Nemo’ (Figure 26), which was written in C# by Alex Etchells (UEA/ENV). Nemo can run the system without the need for human intervention for at least six weeks, and also allows for remote access and control of the system via ‘Teamviewer’ software. Calibration procedures are

programmed to run at pre-defined time intervals that are user-settable. Nemo also automatically ‘flags’ suspect data and alerts the user to problems based on approximately 30 diagnostic parameters.

Data processing

The Nemo software collects measurement data from the analysers every second, and produces data files of 2 minutes averages. These two minute averages have been processed in real-time to report data on the calibrated O₂ and CO₂ mole fraction scales. We have developed several IDL programs that create plots of the numerous diagnostic parameters, such as temperatures, flow rates, and pressures, as well as the raw analyser output and calibrated data, on different timescales, from hourly to yearly (e.g. Figure 27). The IDL programs also allow us to plot meteorological data, and to ‘flag’ or select data, based on certain meteorological conditions, or based on known diagnostic information.

Initial Results

Figure 28 shows measurements of CO₂, O₂, and atmospheric potential oxygen (APO), over a 24-hour period on 07 September. APO is an atmospheric tracer that is conservative with respect to land biotic CO₂ and O₂ fluxes, hence variations in APO represent mostly only oceanic influences on atmospheric CO₂ and O₂ mole fractions. The red and blue lines along the top of Figure 8 indicate whether air was being sampled from the foremast (blue line) or from the monkey island (red line). During this day, there were three occurrences of the sample air being contaminated by the ship’s exhaust, resulting in elevated CO₂ mole fractions: at 06:00, 13:30, and from 17:15 until 18:00. The magnitude of these spikes in the CO₂ record means that these periods of contamination are easily recognisable in the data, since the variations are too large to be from natural sources.

On 08 September 2013, the data show an increase in CO₂ of about 3.5 ppm and a simultaneous decrease in O₂ of about 30 per meg, however there is little change in APO (see Figure 29). This indicates that from about 08:00 onwards, we were most likely sampling an air mass of continental origin, since we would expect to see a significant change in the APO data if the changes were due to oceanic processes. More in-depth analyses of meteorological data from this time should help us to confirm this initial interpretation of the data.

Figure 30 shows the entire unflagged dataset from the JC090 cruise. In addition to the CO₂ and O₂ event mentioned earlier that occurred on 08 – 09 September, the other notable feature of the dataset is a rapid decrease in O₂ and APO beginning on 13 September, followed by a sharp increase on the 14 September. We are currently not certain whether this is a real event or not, owing to problems with the O₂ analyser that began at about 16:00 on 12 September, and were not resolved until 09:00 on the 14 September, which was just before the O₂ reached its minimum. If real, this event indicates a large oceanic influence on the atmospheric O₂ mole fraction, owing to the large corresponding excursion in APO, and absence of any corresponding signal in the CO₂ data.

In addition to these short-term events, the data show an increasing trend in CO₂ and decreasing trend in O₂, which is expected for this time of year, when the terrestrial biospheric growth period is ending, and respiration begins to dominate over photosynthesis.

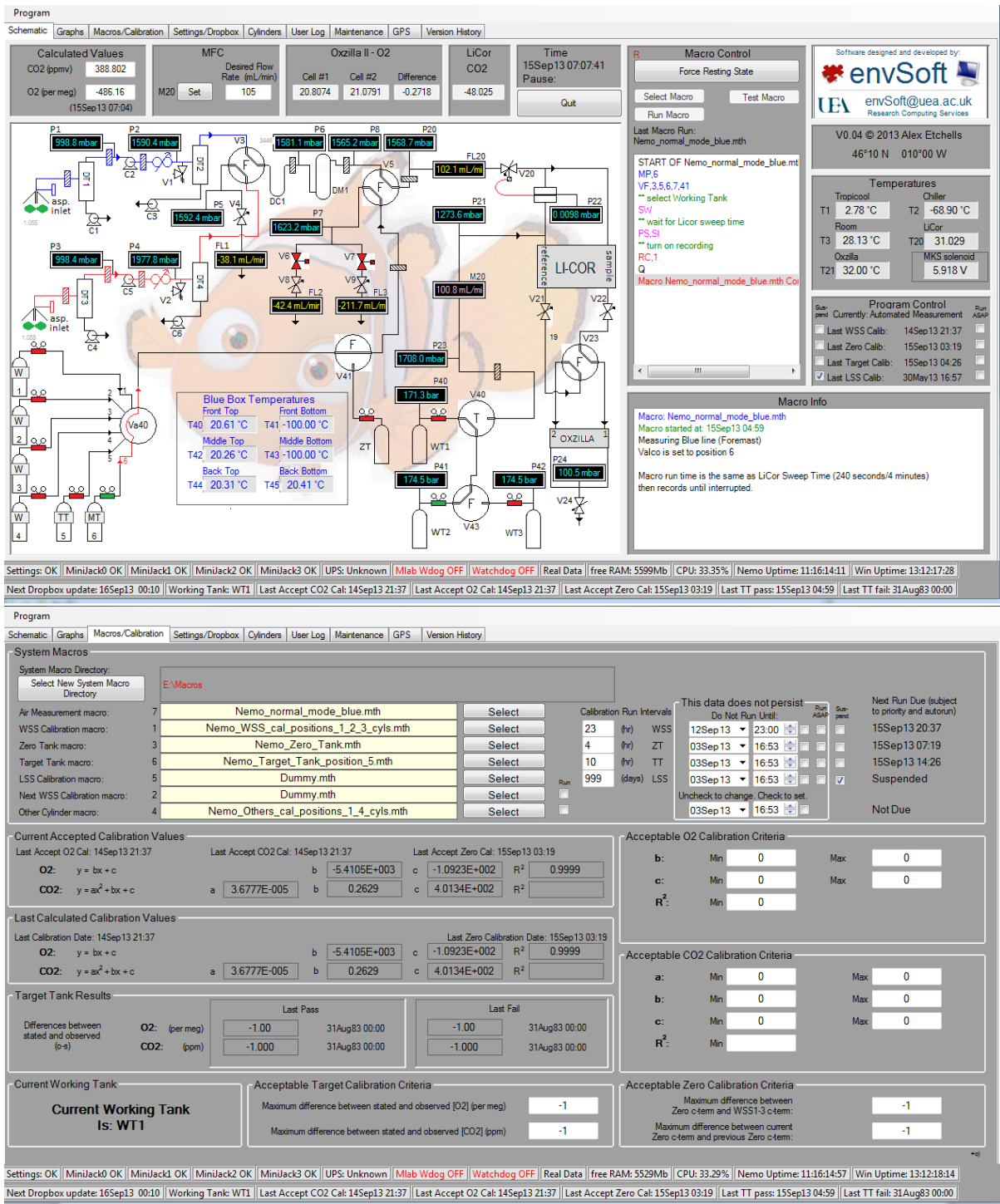

Figure 26: Screen captures of the Nemo software, showing the schematic tab (top) and the calibration tab (bottom).

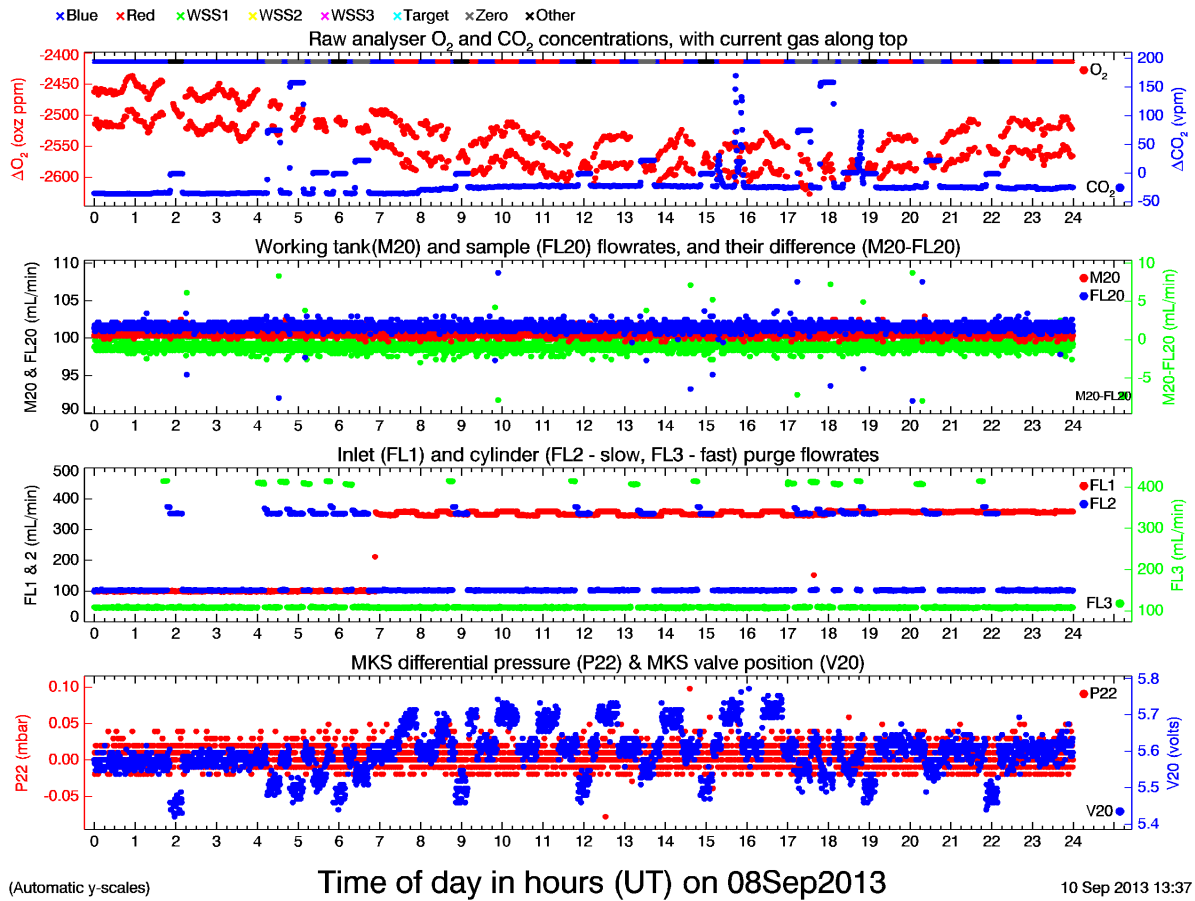

Figure 27: Diagnostic IDL plot from 08 September 2013, showing some of the flow rates and pressures in the gas handling system, as well as the raw analyser output. Such plots are useful for checking the data quality, and for identifying problems in the measurement system.

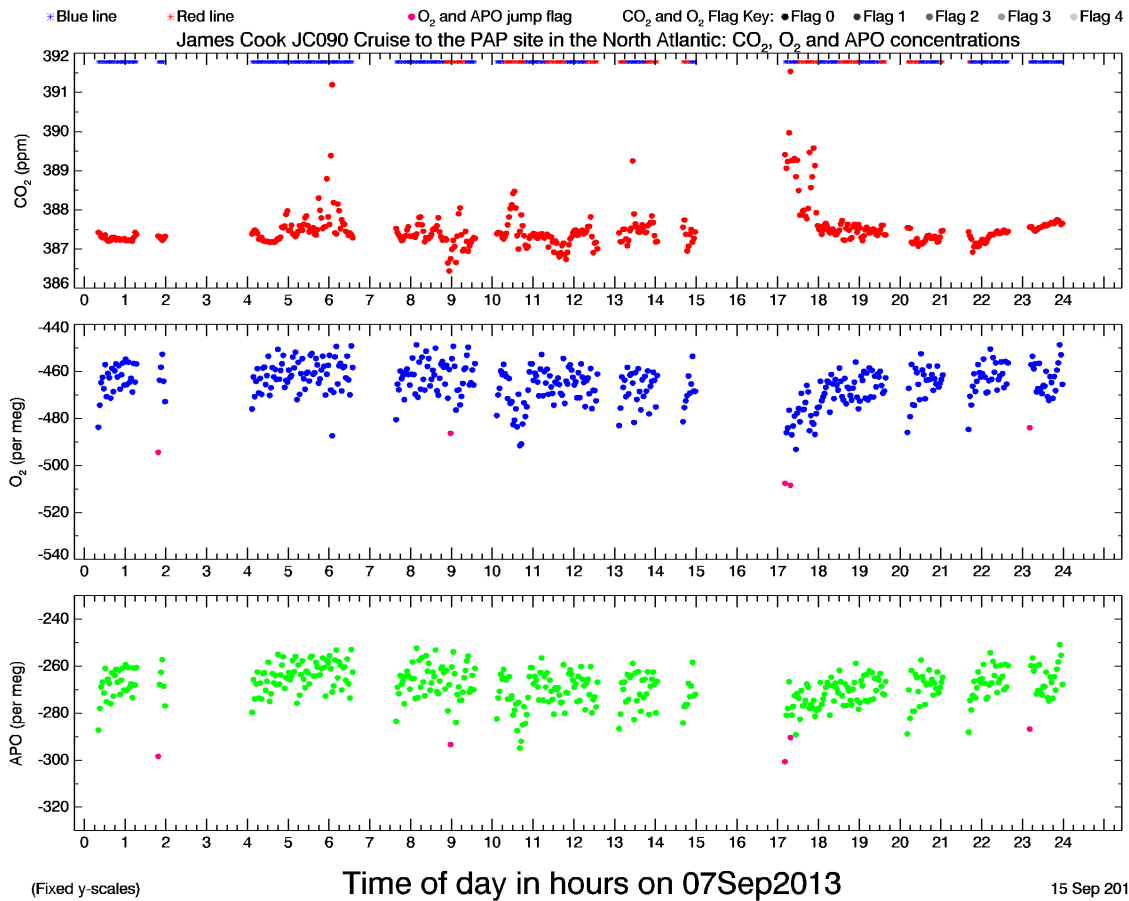

Figure 28: Plot of CO₂, O₂, and APO on 07 September. Pink O₂ and APO data are those that have been automatically flagged due to erroneous ‘spikes’ in the Oxzilla analyser output. Gaps in the data are periods when the system was being calibrated.

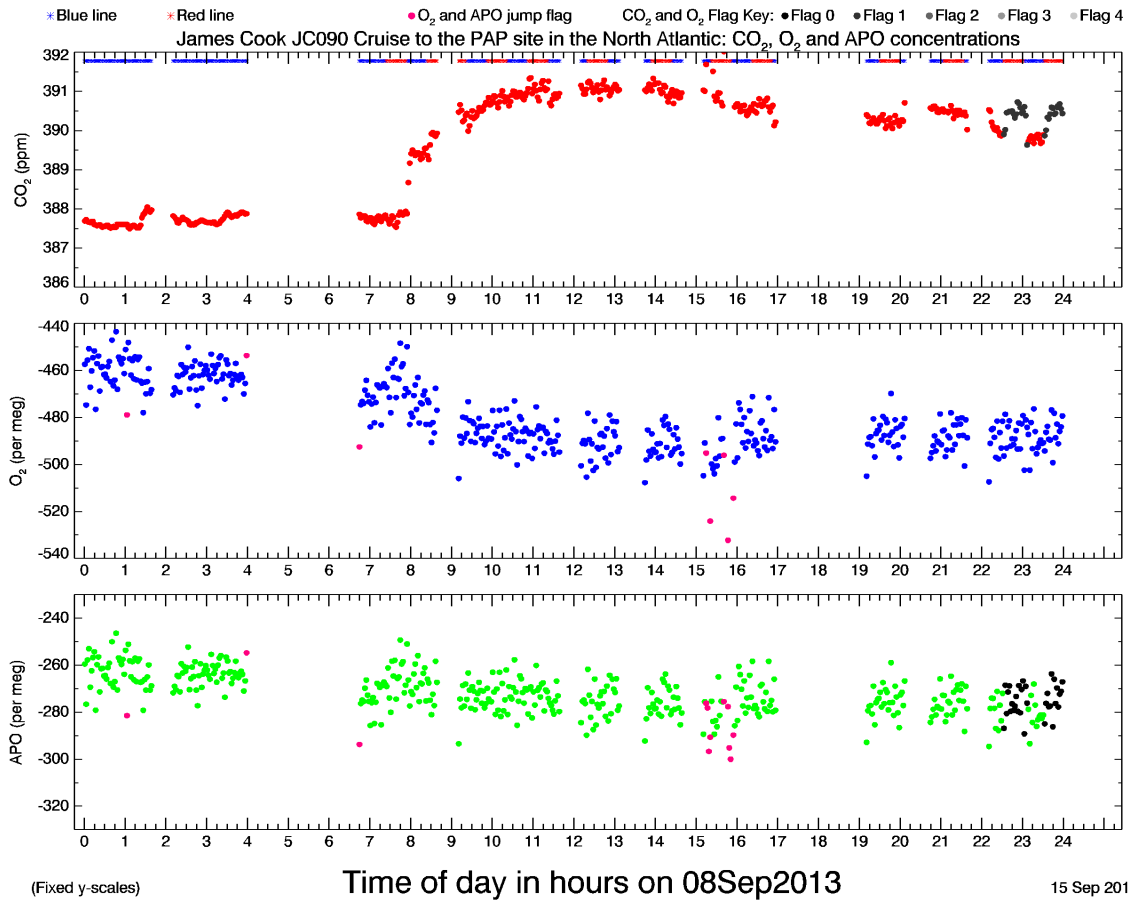

Figure 29: Plot of CO₂, O₂, and APO from 08 September, showing an increase in CO₂ and a simultaneous decrease in O₂, but with little change in APO. Black data points are those that have been manually flagged due to a problem in the monkey island sampling line that developed during this period.

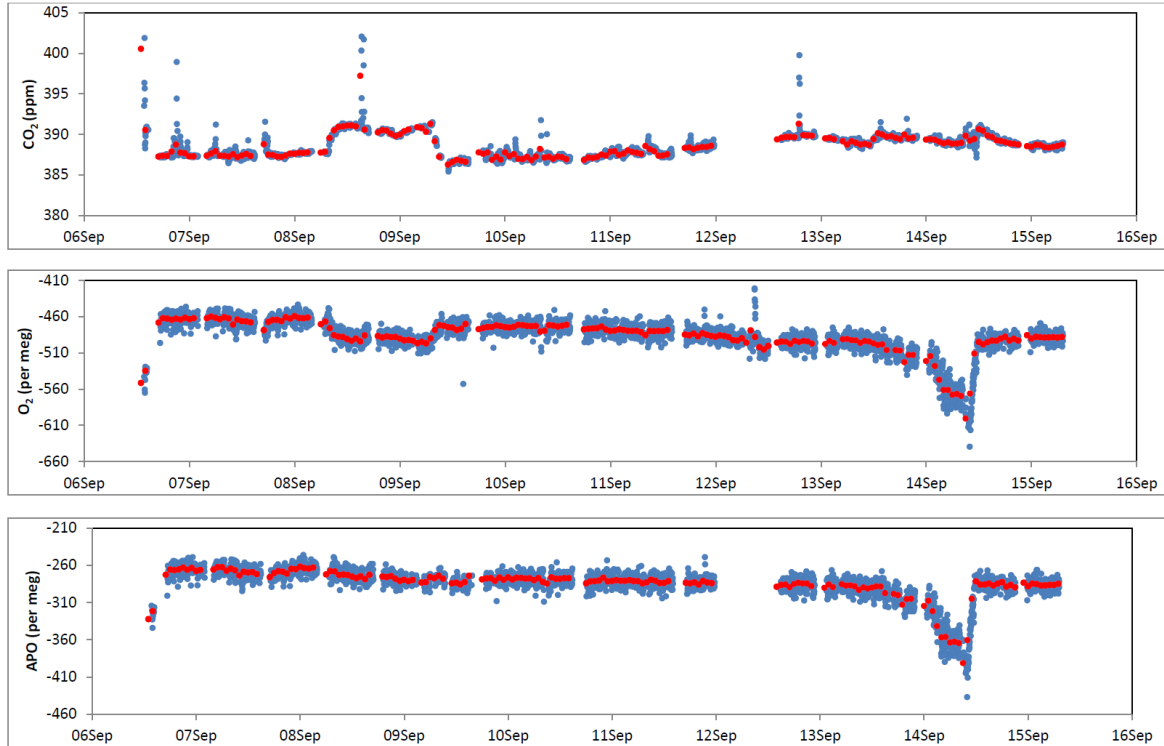

Figure 30: Unflagged 2 minute (blue dots) and hourly (red dots) averages of CO₂, O₂ and APO for the entire period of the cruise.

Problems encountered and cruise outcomes

Our primary aim in joining the JC090 cruise was to rigorously test the measurement system at sea. We wanted to learn exactly how robust and reliable the system was when placed in a challenging environment, and what the areas of weakness were, so that improvements/upgrades can be made before the system is installed on the Lars Maersk. As expected, we encountered several problems and discovered some components of the system that proved to be unreliable, or impractical, many of which would not have come to light in the comparatively stable laboratory environment at UEA.

Firstly, there were several aspects of the installation process that we intend to improve on in order to save time. One example is replacing the electrical connector that powers the blowers in the aspirated air inlets with a smaller alternative, since it proved to be very difficult to pass the power cable through some of the narrow pipes and ‘goose necks’ on the ship in order to run our inlet line down to the Meteorological Lab. Additionally, we found that some of the electronic connections in the system had loosened during transit to Spain. These will need to be re-done and made more robust in order to withstand the vibrations and motions experienced on board the Lars Maersk.

A second problem was that the delivery pressure from the working tank cylinder regulators continually crept upwards, and had to be reset by hand at least once a day. Of course, we were able to fix this because we were on board, but this will not be the case on the Lars Maersk, hence we will need to replace these regulators with more suitable alternatives.

On 05 September, one of the two diaphragm pumps in the gas handling system malfunctioned (see Figure 31). Fortunately, the system has two inlet lines, and so we were able to continue to make measurements while we attempted to fix the pump. A few days later, however, the precision of the CO₂ measurements increased several fold overnight, owing to a leak in the same pump. Consequently, we have decided to find more reliable replacements for these pumps.



Figure 31: Photographs showing damage to one of the diaphragm pumps as indicated by the black residue (left, below the pump rotating shaft) and the suspected cause of the damage, which was trapped water inside the pump head (right).

On 09 September, an offset in the CO₂ data developed between the red and blue lines, which we diagnosed as a leak in the red line Synflex tubing. We were puzzled by this, as a comprehensive leak test before measurements began had indicated that the line was leak-tight. Again we were suspicious of the pump, however, we verified conclusively in this case that the problem was not with the pump. As a result, we had to discontinue the line switching, and sample only from the foremast (blue) line for the remainder of the cruise. One key insight from the cruise, was the great value of having two inlet lines, since the only reason a problem in the red line was apparent, was because of the elevated CO₂ offset compared to the blue line. No other diagnostic parameters suggested a problem, and even the CO₂ short-term precision did not become worse.

Although we were only able to switch between the two lines for three days, we learnt that the majority of the air we sampled from the monkey island (red) line did not show any sign of contamination, even though the inlet was situated relatively close to the exhaust stack (~ 15 m away). Contamination from the ship was sampled at both inlets, and air sampled from the monkey island was only contaminated slightly more frequently than air from the foremast inlet. This gives us confidence that our inlets on the *Lars Maersk* should remain largely free from contamination from the ship's exhaust, since the ship is much longer than the *RRS James Cook*, and therefore our inlets will be situated significantly further away from the exhaust stack than they were during this cruise.

Acknowledgements

We would especially like to say a very big thank you to Alberto Naveira Garabato (NOC) for allowing us to participate on this cruise, and also to Karen Haywood (UEA), who originally told us about the cruise, and pointed us in Alberto's direction. There are several people who helped us with the installation of our equipment that we would like

to thank: Dan Comben, Paul Provost, Martin Bridger, and Paul the electrician. Alex Forryan cheerfully carried out the many logistical tasks to ensure we and our equipment got on the ship. We would also like to thank Steve Woodward (UEA) for arranging the shipping of the equipment to Spain and helping out on the ship, and Simon Ellis (UEA) for helping us to transport the equipment to and from Southampton. Finally, there are numerous other UEA colleagues who we have not named who helped to build and develop the system; we are very grateful for all their hard work.

Vessel Mounted Acoustic Doppler Current Profiler (VMADCP) – *Alex Forryan*

Instrument setup and performance

There are two vessel-mounted Acoustic Doppler Current Profilers (ADCPs) onboard *RRS James Cook* that are used to estimate the horizontal velocity field. These instruments, installed on the port drop keel of the ship, are 75 kHz and 150 kHz Ocean Surveyor (OS) instruments supplied by Teledyne RD Instruments, Poway, California. The different frequencies of the two instruments affect both their depth range and resolution. The 150 kHz allows smaller depth bins and consequently higher vertical resolution, but the signal is more rapidly attenuated and typically only penetrates to ~ 500 m. The 75 kHz lacks such good vertical resolution but penetrates to ~ 1000 m. The instruments can be operated with the keel either retracted or lowered (hereafter known as ‘keel up’ and ‘keel down’ respectively). The keel up position allows greater ship speed, as the vessel is limited to 10 knots with the keel down, but also exposes the instrument to more bubbles, which significantly reduces its profiling range.

During JC090 only one instrument, the 75 kHz, was working this was run in narrow-band single-ping mode with the keel up throughout the cruise. To obtain the highest vertical resolution the instrument was configured for 55 8 m bins (see ADCP command file below).

Fixed calibration

As outlined in the JC029 cruise report, it is known that the OS75 instrument is roughly 9° out of alignment. Consequently, the EA00900 command setting, which sets a rotation angle of 9 degrees, was used in the control file to enable real time monitoring of the currents and for internal VmDas processing.

The best calibration estimates are obtained when the velocity data is collected using the seabed as a reference. However, bottom track calibration estimates are only obtainable when the water depth is within the ADCP profiling range. For this cruise there was insufficient good quality data obtained while the water depth was within the ADCP profiling range. Consequently it was decided to use the calibration from cruise JC090 as follows for the OS75 rotation angle = -0.25 and amplitude = 1.004 , which when combined with the rotation angle set in the control file gives a net rotation angle of 8.75 .

Performance

A not unexpected consequence of running keel up was that the data quality for the instrument was uniformly poor while underway with wind speeds in excess of a couple of knots. Unfortunately these conditions prevailed for most of the cruise. However, reasonable data quality was achieved while on station.

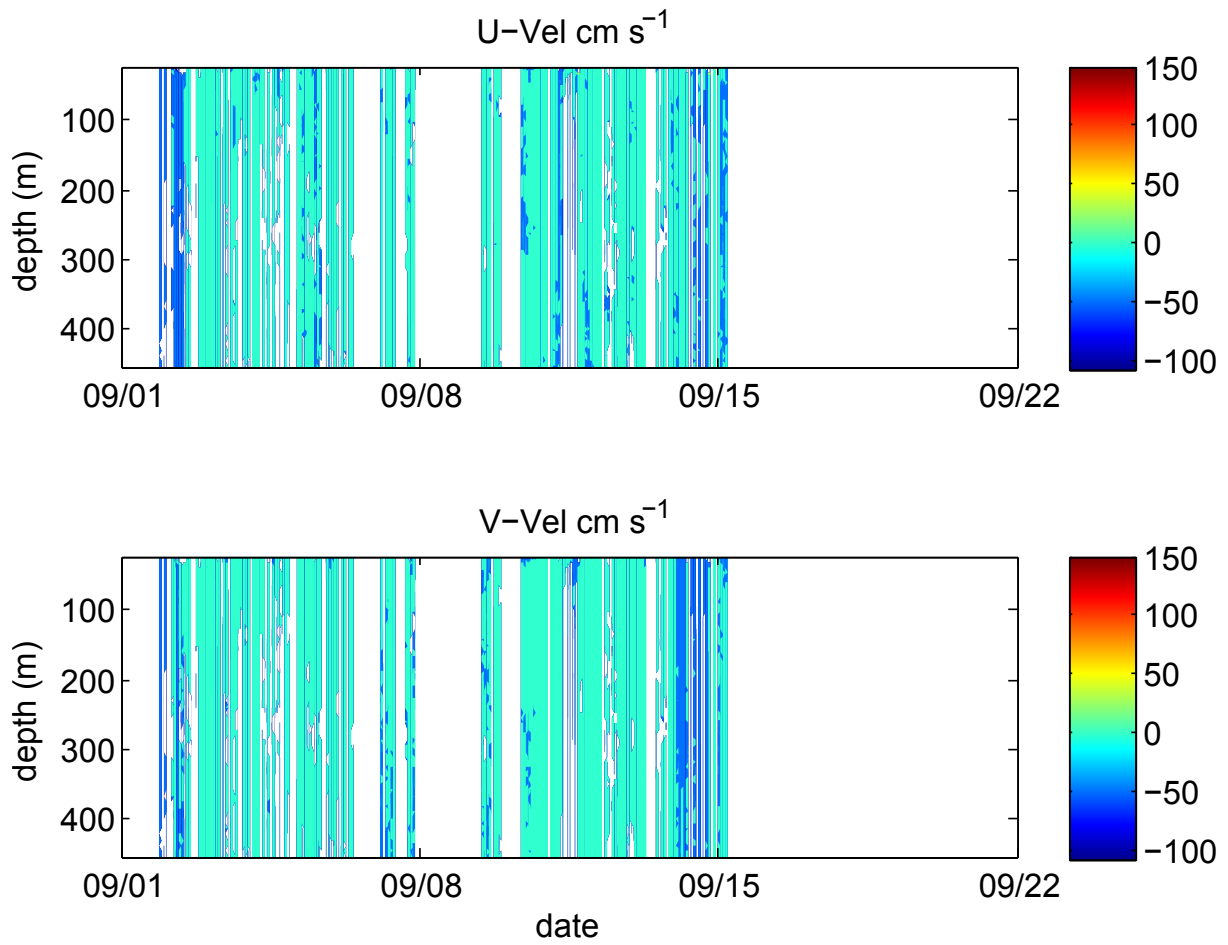

Figure 32: U and V velocity estimates from the 75 kHz VMPACP for cruise JC090. White gaps indicate when the data was of too poor a quality to yield a value.

Real Time Data Acquisition

The data from the two instruments were acquired using the RD Instruments VmDas software package. This software is installed on two PCs in the main laboratory, which control the 75kHz and 150kHz Ocean Surveyor instruments respectively. The software allows data acquisition in a number of configurable formats and performs preliminary screening and transformation of the data from beam to Earth coordinates.

Files Produced by VmDas

The files we produced have names of the form *os<inst>_jc090<nnn>_<filename>.<ext>*, where *<inst>* is the instrument name (75 or 150), *<nnn>* is the file sequence number, *<filename>* is the number of the file in the sequence and *<ext>* is the extension.

The list of files produced is given below:

- .ENR files are the binary raw data files.
- .ENS files are binary ADCP data after being screened for RSSI and correlation and with navigation data included.
- .ENX files are ADCP single ping data and navigation data after having been bin-mapped, transformed to Earth coordinates and screened for error velocity and false targets.
- .STA files are binary files of short-term average ADCP data
- .LTA files are binary files of long-term average ADCP
- .N1R files are ASCII text files of raw NMEA navigation data from the NMEA1 stream.
- .N2R files are ASCII text files of raw NMEA navigation data from the NMEA2 stream.
- .NMS files are binary files of navigation data after screening.
- .VMO files are ASCII text files specifying the option settings used for the data collection.
- .LOG files are ASCII text files logging all output and error messages.

These files were stored in */vmadcp/jc090_os75* (for 75kHz transducer data)

Post-Processing

The final processing of the data was done using the CODAS (Common Ocean Data Access System) software provided by the University of Hawaii. This suite of Unix and Matlab programs allows manual inspection and editing of bad profiles and provides best estimates of the required rotation of the data, either from water profiling or bottom tracking. The processing was done following the methodology applied on D346.

Setting Up the Directories and loading the data

1. *vmadcp_movescript2* was typed in the Unix command window. This creates a new directory called *rawdata<nnn>* (*nnn* denoting the file sequence) and moves the relevant data to this new location.
2. The command *adcptree.py jc090<nnn>nbenx --datatype enx* was typed at the command window. This command sets up a directory tree for the CODAS dataset and an extensive collection of configuration files, text files and m files.
3. Then the command '*quick_adcp.py --cntfile q_py.cnt*' was used to load the data into the directory tree, perform routine editing and processing and make estimates of both water track and (if available) bottom track calibrations. The raw ping files are also averaged into 5-minute periods. The calibration values are stored in the *adcp.cal.out* and *btcaluv.out* files found in the *cal/watertrk* and *cal/botmtrk* directory respectively and are appended each time *quick_adcp.py* is run.

Manual editing

The data were then checked in Gautoedit. The Gautoedit package within CODAS allows the user to review closely the data collected by VmDas and flag any data that is deemed to be bad. These flags can then be passed forward and, using the Unix command "*quick_adcp.py -cntfile q_pyedit.cnt*", the discarded data was removed.

Creating the Output Files

Once the editing and rotations were completed, the final velocities were collated into Mstar files (*.nc) using the Matlab *mcod_01* and *mcod_02*.

The output files produced (*os75_jc090<nnn>nnx.nc*) include the following variables:

- time - (in seconds since [2010 1 1 0 0 0])
- lon - (0 to 360)
- lat - (-90 to 90)
- depth - (of bin)
- uabs - (absolute *u* velocity in cm/s)
- vabs - (absolute *v* velocity in cm/s)
- uship - (*u* velocity of ship over ground)
- vship - (*v* velocity of ship over ground)
- decday - (decimal day of year)

The second file is of the form *os75_jc090<nnn>nnx_spd.nc* and includes, (in addition to the above variables):

- speed - (scalar water speed in cm/s)
- shipspd - (scalar ship speed over ground in cm/s).

The individual *os75-jc090<nnn>nnx_spd.nc* and *os150-jc090<nnn>nnx_spd.nc* files were then appended together into a single output file for the cruise using a script called *mcod_mapend*. The final output files are *os75-jc090nnx_01.nc* and *os150-jc090nnx_01.nc* which contain appended on-station and underway data.

The files *os75-jc090nnx_01.nc* and *os150-jc090nnx_01.nc* contain the VMADCP data for the whole cruise.

ADCP 75Hz Command file

```

;-----\
; ADCP Command File for use with VmDas software.
;
; ADCP type:      75 Khz Ocean Surveyor
; Setup name:     NB, BT off
; Setup type:     Low resolution, long range profile(narrowband)
;
; NOTE:  Any line beginning with a semicolon in the first
;        column is treated as a comment and is ignored by
;        the VmDas software.
;
; NOTE:  This file is best viewed with a fixed-point font (e.g. courier).
; Modified Last: 01November2008 for JC29 (SOFINE)
;-----/

; Restore factory default settings in the ADCP
cr1

; set the data collection baud rate to 38400 bps,
; no parity, one stop bit, 8 data bits
; NOTE:  VmDas sends baud rate change command after all other commands in
; this file, so that it is not made permanent by a CK command.
cb611

; Set for narrowband single-ping profile mode (NP),
; fifty-five (NN) 8 meter bins (NS),
; 8 meter blanking distance (NF)
WPO
NN055
NP00001
NS0800
NF0800

; enable single-ping bottom track (BP),

```

```
; Set maximum bottom search depth to 1200 meters (BX)
BP001
BX12000

; output velocity, correlation, echo intensity, percent good
ND111100000

; One and a half seconds between bottom and water pings
TP000150

; Three seconds between ensembles
; Since VmDas uses manual pinging, TE is ignored by the ADCP.
; You must set the time between ensemble in the VmDas
; Communication options
TE00000300

; Set to calculate speed-of-sound, no depth sensor, external
; synchro heading sensor, no pitch or roll being used,
; no salinity sensor, use internal transducer
; temperature sensor
EZ1020001

; Output beam data (rotations are done in software)
EX000000

; Set transducer misalignment (hundredths of degrees)
EA00900S

; Set transducer depth (decimeters)
ED00069

; Set Salinity (ppt)
ES35

; save this setup to non-volatile memory in the ADCP
CK
```

Underway Systems – *Alex. Forryan*

The raw data underwent a series of post processing programs from the mexec suite as follows;

mday_00_get_all(day) Retrieves data from techsas.

mgyr_01 Post processing gyro data.

mash_01 Post-processing Ashtech data.

mday_02_run_all(day) Appends the days file to the running logs.

mbest_all(day) Calculates the 'best' position by combining the different navigation streams.

mtruewind_01 Calculate true wind data.

Running logs of the whole cruise are updated daily using the mday_02 command. The files must be added sequentially in order. It is possible to check what order the files have been logged by checking the header using *mlisth*. The true wind direction was calculated by combining the measured relative wind speed and direction with the calculated 'best' navigation data.

Thermosalinograph

A SBE45 MicroTSG, takes temperature and conductivity measurements and is fitted in the wet lab and draws on seawater supplied from an inlet situated in the hull of the ship. Throughout the cruise salinity samples were taken from the non-toxic supply located upstream of the SBE45 every 6 hours.

A basic ratio calibration was applied to the TSG conductivity using the measured conductivity from the bottle samples post cruise.

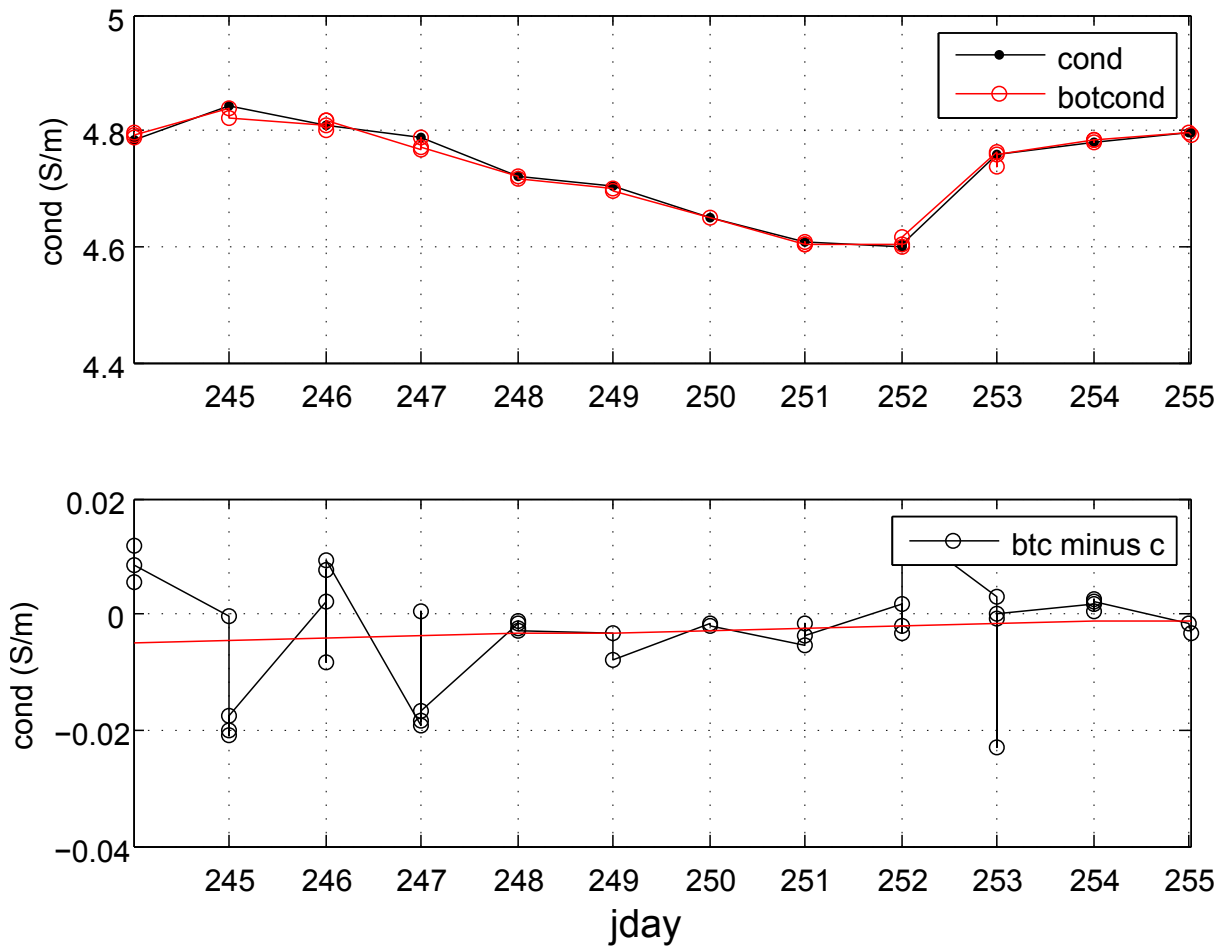

Figure 33: Comparison of recorded conductivity from underway systems TSG with bottle sample conductivity.

Acknowledgements

This work was supported by the U.K. Natural Environment Research Council through a Directed Research Programme on the Ocean Surface Boundary Layer (grant NE/I019999/1).