

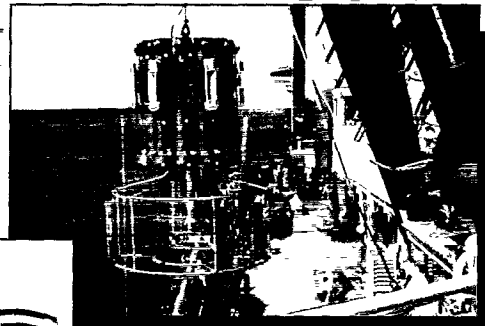

**Southampton
Oceanography
Centre**

Cruise Report

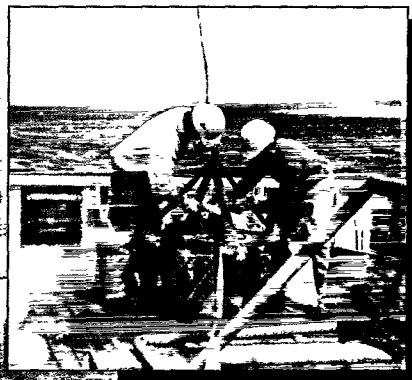
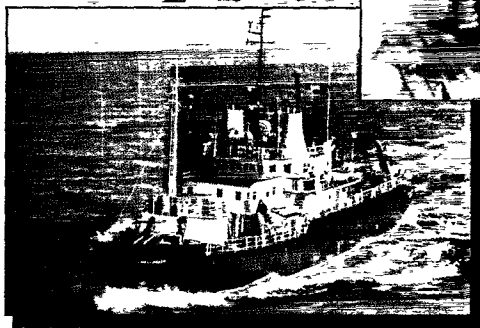
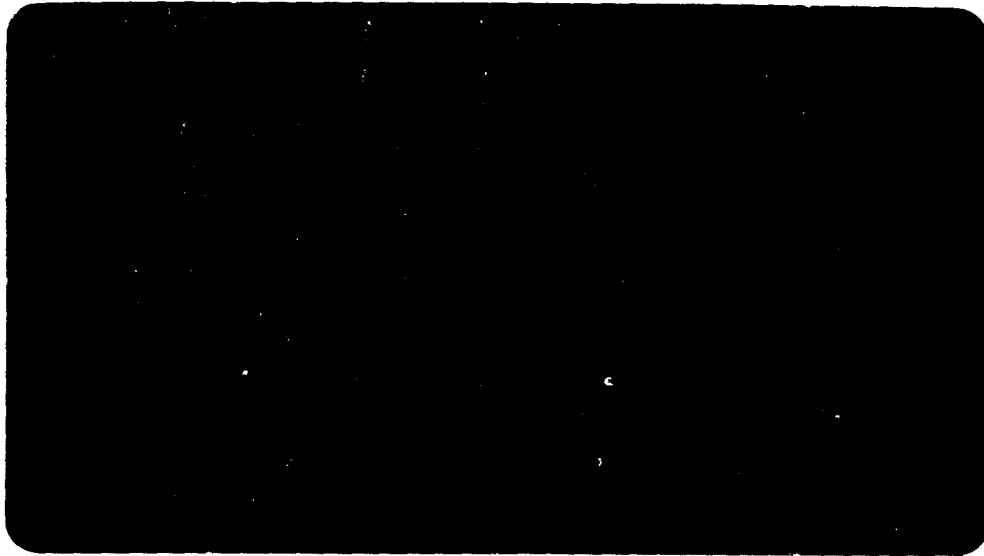

**University
of Southampton**

SOUTHAMPTON OCEANOGRAPHY CENTRE

CRUISE REPORT No. 21

RRS *CHARLES DARWIN* CRUISE 108

14 SEP - 16 OCT 1997

TOBI and MULTIBEAM surveys of
submarine landslides around the Canaries

Principal Scientist
D G Masson

1998

Challenger Division for Seafloor Processes
Southampton Oceanography Centre
Empress Dock
European Way
Southampton SO14 3ZH
UK
Tel: +44 (0)1703 596568
Fax: +44 (0)1703 596554

DOCUMENT DATA SHEET

AUTHOR MASSON, D G et al	PUBLICATION DATE 1998	
TITLE RRS <i>Charles Darwin</i> Cruise 108, 14 Sep-16 Oct 1997. TOBI and MULTIBEAM surveys of submarine landslides around the Canaries.		
REFERENCE Southampton Oceanography Centre Cruise Report, No. 21, 35pp.		
ABSTRACT <p>The overall objective of the cruise was to examine the contribution of large-scale landsliding to the evolution of the western Canary Islands. Aims included the production of a comprehensive assessment of the effects of catastrophic landslides, including analysis of their frequency, triggering mechanisms and volumes, as well as studies of landsliding processes. The main tools used included swath bathymetry, TOBI high-resolution sidescan sonar and 3.5 kHz and seismic profiling. The survey programme concentrated on three areas where landsliding was believed to be most active: the northern flank of Tenerife, the flanks of the island of La Palma and the flanks of the island of El Hierro. The cruise was highly successful, obtaining swath bathymetry and EM12 sidescan sonar data covering much of the flanks of Tenerife, El Hierro and La Palma. Large-scale slope failures are more abundant on these island flanks than had previously been recognised and at least ten slope failure events can be recognised from the new data. TOBI sidescan sonar images from key areas show varied flow processes including debris avalanche, sediment slide and debris flow.</p>		
KEYWORDS CANARY ISLANDS, CHARLES DARWIN, CRUISE 108 1997, DEBRIS FLOW, EL HIERRO, LA PALMA, SEISMIC PROFILING, SUBMARINE LANDSLIDES, SWATH BATHYMETRY, TENERIFE, TOBI		
ISSUING ORGANISATION Southampton Oceanography Centre Empress Dock European Way Southampton SO14 3ZH UK Director: Professor John Shepherd		
<i>Copies of this report are available from:</i>	National Oceanographic Library, SOC	PRICE: £8.00
Tel: +44(0) 01703 596116	Fax: +44(0) 01703 596115	Email: nol@soc.soton.ac.uk

CONTENTS

	PAGE
SCIENTIFIC PERSONNEL	6
SHIP'S PERSONNEL	7
ITINERARY	9
CRUISE OBJECTIVES	9
SURVEY PROGRAMME	9
NARRATIVE	1 1
MULTIBEAM OPERATIONS	1 6
TOBI OPERATIONS	1 6
SEISMIC PROFILING	1 7
DREDGING	1 8
PRELIMINARY RESULTS	1 9
REFERENCES	2 0
TABLE 1	2 1
FIGURES	

SCIENTIFIC PERSONNEL

MASSON, D.G.	Southampton Oceanography Centre
WATTS, A.B.	University of Oxford
WYNN, R.B.	Southampton Oceanography Centre
REEDER, M.S.	Southampton Oceanography Centre
BANNISTER, K.M.	Southampton Oceanography Centre
GEE, M.J.	University of Oxford
WYER, P.P.	University of Oxford
MITCHELL, N.C.	University of Oxford
URGELES ESCLASANS, R.	University of Barcelona
PAULSON, C.J.	Research Vessel Services
BOOTH, D.G.	Research Vessel Services
HUNTER, C.A.	Research Vessel Services
DAY, C.	Research Vessel Services
SCOTT, J.E.	Research Vessel Services
SHERRING, A.	Research Vessel Services
FERN, A.M.	Research Vessel Services
PEARCE, R.O.	Research Vessel Services
TAYLOR, A.J.	Research Vessel Services

SHIPS PERSONNEL

PLUMLEY, R.C.	Master
NEWTON, P.W.	Chief Officer
OLDFIELD, P. T.	2nd Officer
WARNER, R. A.	2nd Officer
RANT, B.N.	Radio Officer
McGILL, I.G.	Chief Engineer
GREENHORN, A.	2nd Engineer
PHILIPS, C.J.	3rd Engineer
LUTEY, W. D.	Electrician
LEWIS, T.G.	CPOD
WYNESS, M.J.	POD
SQUIBB, M.	Seaman 1A
THOMSON, I.N.	Seaman 1A
BUFFREY, D.G.	Seaman 1A
KESBY, S.	Seaman 1A
BRIDGE, A.M.	POMM
BELL, R.	Senior Catering Manager
LYNCH, P.A.	Chef
SWENSON, J.J.	M/Steward
MINGAY, G.	Steward
DILLON, C.V.	Steward

ITINERARY

Sailed Southampton, UK
Arrived Lisbon, Portugal

14th September, 1997
16th October, 1997

CRUISE OBJECTIVES

The main objective of the cruise was to examine the overall contribution of large-scale landsliding to the evolution of the Canary Islands (Fig. 1). The major aims of the proposed study were :

- (i) to use swath bathymetry and high-resolution seismic profiling to produce a comprehensive assessment of the effects of catastrophic landslides on the flanks of the Canary Islands
- (ii) to use TOBI high-resolution sidescan sonar to look in detail at selected areas of landslides to obtain further insights into landsliding processes
- (iii) to examine the frequency of landslides, their possible triggering mechanisms, the geological processes involved in landsliding, the volumes of material involved, and possible relationships to external influences (e.g. sealevel)
- (iv) to determine the wider influence of landslides in the subsidence and uplift history of the Canary Islands and of volcanic islands in general

SURVEY PROGRAMME

The survey programme was based on three areas where landsliding was believed to be most active :

- (i) the northern flank of Tenerife
- (ii) the flanks of the island of La Palma
- (iii) the flanks of the island of El Hierro

(i) Earlier studies have shown that the central section of the north flank of Tenerife has been subjected to a complex history of landsliding (Watts and Masson, 1995). It was recognised that several phases of landsliding had occurred, but individual events were poorly documented and their inter-relationship was not well understood. The main aims in this area were to :

(a) expand on the swath bathymetry survey carried out on *Charles Darwin* Cruise 82 (Watts et al, 1994) in order to gain a better understanding of the distribution of landslide scars and deposits and to clarify the morphological differences between areas affected by landsliding and adjacent areas of stable slope.

(b) collect TOBI sidescan sonar data in the area of the major landslide complex, to differentiate the deposits of the various landslide events and to try to understand the

landslide flow processes through analysis of the detailed morphological character of the landslide deposits.

(c) collect dredge samples from areas of slope which have not been subjected to landsliding, to test the hypothesis that these slopes are composed of subaerially erupted material which has been subjected to a large amount of subsidence.

(ii) The southern part of the island of La Palma is most volcanically active part of the Canary Islands (Carracedo et al, 1997). The rapid build up of the island has created a very steep sided edifice and it is likely that this area will be affected by landsliding at some future time. The northern part of the island records a much older westward-directed landslide, dating from about 0.7 Ma (Carracedo et al, 1997). The main aims in this area were to :

(a) collect swath bathymetry data along the flanks of La Palma in order to examine evidence for past landslides and to look for possible evidence of present day instability. Survey of the west flank of the island was deemed to have a higher priority than that of the east, which may be partly buttressed by Tenerife, and thus less susceptible to landsliding.

(b) collected TOBI sidescan sonar data over areas of landslides deposits, to examine failure morphology and deduce debris transport mechanisms. This aim depends on the discovery of debris deposits during the swath survey.

(iii) The island of El Hierro is the youngest of the Canary Islands and is known to have suffered at least two major flank failures (Masson, 1996). The El Golfo Debris Avalanche (and related Canary Debris Flow) is the youngest landslide event in the Canary Islands, with an age of about 15,000 years. The main aims in this area were to :

(a) Obtain complete swath bathymetry coverage of the island flanks, in part building on earlier coverage obtain from the Spanish research vessel B.I.O. *Hesperides*, to gain an overview of how landsliding has affected the evolution of the island.

(b) Collect TOBI sidescan sonar data to the south of the island, where the Saharan Debris Flow has overrun the distal part of the El Julian Debris Avalanche, to examine the avalanche/debris flow interaction and to map the structure of the avalanche deposit.

(c) Add to the TOBI sidescan sonar mosaic obtained over part of the El Golfo Debris Avalanche and proximal Canary Debris Flow during R.R.S. *Discovery* Cruise 205 in 1993 (Masson, 1994). These data would be used test and refine models of debris flow initiation due to loading of sedimented slopes by debris avalanches (Masson et al, in press).

NARRATIVE

CHARLES DARWIN sailed from Southampton at 1000 on Sunday the 14th September. The passage towards the working area off the Canaries occupied the next 3 days. Scientific operations began on the 18th September (day 261).

Day 261 (Thurs 18th September)

0800 : on station for sound velocity probe dip
0920 : launch 3.5 kHz fish
0925 : launch PES fish (this failed immediately)
1150 : complete sound velocity profile
1320-2015 : calibration run of the EM12 multibeam system
2020 : recover PES fish for repairs
2025 : continue passage towards Canaries

Day 262 (Fri 19th)

0845-1500 : streamed 8000 m of new conducting cable
1650 : relaunched repaired PES fish

Day 263 (Sat 20th)

Continue passage towards first working area around NE Tenerife
2045 : Start multibeam survey north and northeast of Tenerife.

Day 264 (Sun 21st)

Continue multibeam survey north and northeast of Tenerife.
0718 : deploy seismic profiling system on two lines parallel to the coast north of Tenerife.
300 in³ airgun and 4 channel streamer. Airgun refused to seal on deployment.
Continued first line at 3 kts while airgun was repaired.
0935 : airgun repaired and redeployed. Magnetometer deployed.
0950 : Start seismic survey. 300 in³ airgun with wave shape kit, firing rate 8 s, ships speed 6 kt.

Day 265 (Mon 22nd)

0900 : Completed seismic survey and recovered gear. Increase speed to 10 kts for passage to El Hierro. Discovered problem with seismic recording system. Data between 1723/264 and 0900/265 had failed to record. Recording system had given no indication of any problem.
1330 : Start of multibeam survey around El Hierro.

Day 266 (Tues 23rd)

0530 : First circuit of the El Hierro completed at an average distance of 1.5 miles. Excellent multibeam data of El Golfo embayment and a second possible failure off the east coast of the island.

1000 : began seismic profiling and multibeam survey off the east coast of El Hierro. During the day confirmed that a debris avalanche deposit existed off Las Playas embayment on the east side of the island. Continued this survey for the remainder of the day.

Day 267 (Wed 24th)

0000-1830 : Completed seismic profiling and multibeam survey off the east coast of El Hierro.

2000 : Seismic gear recovery complete

2000 - : Began multibeam survey of El Julan embayment on the southwest flank of El Hierro.

Day 268 (Thurs 25th)

0000-1000 : continued multibeam survey of El Julan embayment on the southwest flank of El Hierro.

1100 : Seismic profiling gear and magnetometer deployed. Continued multibeam and seismic profiling survey of El Julan flank for the remainder of the day. At 2049 increased speed to 7.5 kts with little detriment to the seismic record. Debris avalanche visible on multibeam data, but apparently has significant sediment cover.

Day 269 (Fri 26th)

0000-0830 : Continued multibeam and seismic survey of El Julan flank.

0830-0930 : Recovered seismic profiling gear and magnetometer in preparation for TOBI sidescan sonar deployment

0930-1030 : Steamed to TOBI launch position in area of Saharan Debris Flow - El Julan Debris Avalanche boundary

1030-1130 : Launched TOBI

1500 : TOBI at operational depth and collecting data. Continued TOBI survey for remainder of the day

Day 270 (Sat 27th)

Continued TOBI survey in area of Saharan Debris Flow - El Julan Debris Avalanche boundary

Day 271 (Sun 28th)

Continued TOBI survey in area of Saharan Debris Flow - El Julian Debris Avalanche boundary.

1630 : Began TOBI run up the slope of the El Julian Debris Avalanche to examine the structure of the debris avalanche.

Day 272 (Mon 29th)

0000-1100 : Completed TOBI run up the slope of the El Julian Debris Avalanche, finishing in about 1000 m of water and about 3 miles from the island. Obtained excellent images of 'faulted' sedimentary seafloor and volcanic blocks with many similarities to that seen on the El Golfo Debris Avalanche on an earlier cruise. All of the seafloor structures were surprisingly fresh, given the suspected considerable age of the El Julian failure.

1100-1150 : Recovered TOBI at the end of an excellent 3 day run

1150-1310 : Passage to restart point for swath survey around El Hierro

1310-1430 : Continuation of swath survey around El Hierro and on passage to area west of La Palma.

1430-1700 : Hove to for sound velocity dip.

1700 : Start swath survey to the west of La Palma

Day 273 (Tues 30th)

0000-2000 : Continue swath survey to the west of La Palma

2000 : Slow to deploy seismic profiling gear

2000-2045 : seismic profiling gear and magnetometer deployed.

2045 - : Continue swath and seismic survey west of La Palma at 7.5 kts. Included line extending north of the island (to 29° 30' N) to cover field of sediment waves seen on previously collected GLORIA sidescan sonar and 3.5 kHz profile data.

Day 274 (Wed 1st October)

Continue swath and seismic profiling survey west of La Palma at 7.5 kts

Day 275 (Thurs 2nd)

0000-0553 : Continue swath and seismic profiling survey west of La Palma.

0600 : recover seismic profiling gear and magnetometer

0630-0850 : steam to start of TOBI sidescan sonar run 2 west of La Palma

0850-0945 : deploy TOBI

1130: deploy magnetometer

1400 : TOBI finally at operational depth with 8000 m of wire deployed. Start of first run up the slope, parallel and adjacent to the TOBI lines run on *Discovery* Cruise 205.

Day 276 (Fri 3rd)

Continue TOBI survey of proximal Canary Debris Flow/El Golfo Debris Avalanche.

Day 277 (Sat 4th)

Continue TOBI survey of proximal Canary Debris Flow/El Golfo Debris Avalanche. Adverse currents reduce progress over the ground towards the NW to around 1 kt.

Day 278 (Sun 5th)

0000-1500 : ran TOBI survey line up the flanks of La Palma. Abundant avalanche blocks on lower slope.

1500-1605 : recover TOBI

1605-2007 : complete swath survey west of La Palma

2007-2359 : begin swath survey of east coast of La Palma

Day 279 (Mon 6th)

0000-0705 : continue swath survey of east coast of La Palma

0705 -0930 : passage to La Palma

0930-1230 : port call at La Palma to replenish fresh water supply

1230-1800 : passage towards Tenerife to continue swath survey of northern island flank

1800 - : swath survey of north flank of Tenerife, filling gaps in earlier survey, while on route to dredging site.

Day 280 (Tues 7th)

0000-0405 : complete swath survey of north flank of Tenerife, filling gaps in earlier survey.

0405-0743 : dredge site D108/01. Dredge recovered full of mud with a few small pieces of basalt. Dredge probably throttled early in the haul because of failure of 2 ton weak link.

0850-1230 : dredge site D108/02. 2 ton weak link replaced with a 5 ton link to prevent premature throttling of the dredge. Several good 'bites' obtained during the haul, culminating in the loss of the dredge during a modest 3.5 ton pull. On recovery, it was found that the pennant had failed about 60 m from the end. It was clear that the pennant (13 ton breaking strain) was seriously corroded, since it had failed before the two 5 ton weak links in the system.

1300-1638 : dredge site D108/3. Dredge attached directly to the main warp to avoid use of suspect pennants. Two 5 ton weak links used. Dredge on bottom 1442-1600. Recovered with some difficulty after becoming hung up on bottom. On Deck 1638. Again the recovery was rather disappointing, with only a few small basalt fragments, corals and bivalves recovered

1700 -1830 : on passage to start of TOBI run 3.
1848 : TOBI launch complete
2200 : TOBI at operational depth
2200-2359 : TOBI survey of north flank of Tenerife.

Day 281 (Wed 8th)

Continue TOBI survey of north flank of Tenerife, crossing the Orotava and Icod landslide deposits

Day 282 (Thurs 9th)

Continue TOBI survey of north flank of Tenerife, concentrating on the Icod landslide.

Day 283 (Fri 10th)

Continue TOBI survey of north flank of Tenerife, tracing the distal part of the Icod landslide

Day 284 (Sat 11th)

Continue TOBI survey of north flank of Tenerife, running up the Icod landslide and then across the head of the Icod and Orotava landslides.

Day 285 (Sun 12th)

0730 : Finish TOBI survey of the upper part of the Orotava Landslide. Start recovery of TOBI.

1030 : TOBI secured on deck. Passage to start of final swath survey east of La Palma.

1600-2400 : Swath survey east of La Palma.

Day 286 (Mon 13th)

0440 : complete swath survey east of La Palma. Begin passage to Lisbon.

0830 : recover 3.5 and 10 kHz fish. Begin deployment of conducting cable for washing and lubrication.

1630 : complete wire washing. Continue passage towards Lisbon. Speed slowed by poor weather with wind and sea from NE.

Passage to Lisbon completed at 1300/286.

MULTIBEAM OPERATIONS

Multibeam echosounder data were collected along all tracks using the hull mounted Simrad EM12 system on the RRS *Charles Darwin* (Fig. 2).

TOBI OPERATIONS

On sailing from Southampton a number of preliminary tasks were completed to make the vehicle ready for deployment. In particular, the new conducting tow-cable had to be terminated and a means of logging wire-out on the ship's computing system put in place.

Using a standard PC card together with software written by Dave Booth, an output was taken from the winch shaft encoder which was decoded to give an accumulated count and a rate of haul or veer. These parameters were displayed on the screen of the spare TOBI system PC. Additionally an RS232 output from the PC was connected to the ship's computer logging system via a Level A, thus making it possible to merge wire-out with ship navigation data and ultimately with TOBI data. Eventually it is hoped to incorporate these data parameters into the data stream logged on the TOBI system M-O drives.

The conducting tow-cable was terminated with a module to fit the TOBI swivel with no particular problems. The opportunity was taken to document this operation fully with the use of a digital camera so that a handbook could be assembled. The same approach was taken for other significant operations during the pre-deployment phase.

Having terminated the cable, the TOBI vehicle was connected up for a system check at which stage it was discovered that the CTD data was not being sent back. This was eventually resolved by re-installing the software used in a Scorpion micro-controller embedded in the TOBI vehicle electronics, although some minor changes had to be made in the software sent out to the ship in order to make it work reliably.

TOBI was deployed for the first time on the 26th Sept. The only snag encountered was that the link pin on the umbilical cable was too large for the depressor weight and had to be machined down to fit while TOBI was towed at 0.5 knots. After paying out wire and making sonar contact with the sea-bed it was found that the sonar gains were too high and had to be reduced to prevent overloading. It was also necessary to reduce display gain to achieve a satisfactory picture. Later when a turn was executed, loss of trigger pulses was experienced. This was attributed to excessive noise from some unknown source. The problem only occurred in the middle of a turn and usually disappeared when the wire was hauled or paid out. Despite these problems, excellent records were obtained.

After recovery a search was made for sources of noise, electrical as well as mechanical. The swivel and umbilical showed no problems but there were signs of severe fretting at the tow point on the front of the vehicle. An attempt was made to fit a packing in the towing eye in order to reduce the play at this point, and other possibly loose cables and hardware were secured. TOBI was then deployed again for line number 2 on the 2nd October. The same problems with noise were encountered again although the quality of the sonar record seemed unaffected. Towards the end of the line dropouts in the side-scan record were noticed, which since they were in pairs looking at the port and starboard side-scan records, was indicative of swivel slip-ring generated noise. We therefore decided to change the swivel at the end of this deployment.

Prior to the third deployment, having changed the swivel, the umbilical was found to be open circuit at the depressor-weight end. The umbilical was re-terminated at both ends and the vehicle was redeployed for the third line. It was immediately obvious that the noise problem had ceased and the gain controls had to be re-adjusted. The resulting record was even better than those from the previous two lines. However, the CTD data became intermittent for a while but returned later without further problems. This is believed to have been due to a faulty underwater cable or connector. Further tests on the original swivel failed to identify any source of noise.

In all TOBI completed 10.6 days of side-scan survey not including deployment and recovery time, and fulfilled all its planned objectives. It also provided an intensive learning exercise for the RVS TOBI team. A summary of the TOBI survey tracks is given in Fig. 3.

SEISMIC PROFILING

The seismic profiling system was run for a total of 4.5 days. A simple configuration of a 4 channel streamer and a single 300 in³ airgun fitted with a wave shape kit was used throughout (Fig. 4). Although only a single 300 in³ Bolt 1500C airgun was required, it was felt that the Reftek firing system would offer the best options, allowing the gun depth to be monitored (Fig. 5). The SAQ recording system was set to record four channels (running SAQ8N version 1.41 software). The graphic recorder signal, providing real time hard copy of the data, was taken from channel two. Survey speed varied from 6 to 7.5 kt, with little obvious effect on data quality.

Apart from a data collection problem on the first line, when 12 hours of digital data were lost, the seismic profiling system performed well. Minor problems occurred in attempting to seal the airguns, but once sealed they performed satisfactorily. The records were quiet and of good quality, even at speeds in excess of 7 kt, which reduced the gun depth to between 2 and 3 m. The loss of data on the first line occurred when the hard disk on the recording

system became full but no error messages were displayed. The general area of data transfer from the recording system onto an archive/storage system is too slow and needs to be examined. A summary of the seismic profiling tracks is given in Fig. 6.

DREDGING

Three rock dredge stations were occupied with the aim of recovering igneous rocks from the submarine north flank of Tenerife, to test the hypothesis that these slopes were formed subaerially and subsequently subjected to a large amount of subsidence. The site chosen was on the seaward side of a small plateau with a summit depth of about 1600 m and a steep seaward slope extending to below 2000 m waterdepth (Table 1). This offered an area of slope which was protected, by its topographic situation, from downslope transport of material from higher on the slope, thus maximising the probability of recovering in situ igneous rock.

The rock dredge was set up as follows : two weak links attached the dredge to 3 m of heavy chain (weighing 350 kg), in turn attached to a 200 m pennant, in turn attached to the coring wire. A pipe dredge was towed behind the main dredge, with the aim of collecting any fine grained material present. The weight of the chain was intended to keep the dredge in contact with the seafloor. If the dredge became stuck on the seafloor, breaking the first weak link would transfer the pull to a second wire woven through the chain mesh of the dredge. This had the dual effect of closing the dredge bag and changing the pull angle, with the intention of turning the dredge over and freeing it.

For the first dredge attempt (CD108/1), weak links of 2 and 5 tons were used. Only one small 'bite' was observed, during the early part of the haul. On recovery, both the main and pipe dredges were found to be full of mud, which contained only a few rock fragments and some shelly material (Table 1). The 2 ton weak link was found to have broken, accounting for the lack of 'bites' as the dredge was pulled up the rocky slope. For the second attempt (CD108/2), the core site was moved slightly to the west, to the area of steepest slope. Two 5 ton weak links were used, to avoid premature closing of the dredge bag by failure of the 2 ton link, now judged to be too weak. Several good 'bites' were obtained before the dredge became stuck. On applying about 4 tons of pull, it appeared to come free. When recovered, however, it was found that the pennant (13 ton breaking strain) had broken, almost certainly due to having been weakened by severe corrosion. The third attempt (CD108/3) was a direct repeat of site CD108/2. The dredge was attached to the coring warp directly, with no pennant, because the available spare pennants were judged to be in the same poor state as that which had broken during attempt 2. Two 5 ton weak links were used. As with the previous attempt, several good 'bites' were obtained before the dredge became stuck. After pulling the ship almost directly over the core

site, it came free and was recovered. As with CD108/1, site 3 produced only a few rock fragments, with assorted coral and shell debris.

PRELIMINARY RESULTS

The new swath bathymetry and EM12 sidescan sonar data covering much of the flanks of the western Canary Islands of Tenerife, El Hierro and La Palma show that large-scale slope failures have a wider distribution than has previously been recognised. High-resolution deep-tow sidescan sonar (TOBI) images from key areas give details of the morphology of failure deposits and allow failure processes to be inferred. At least ten slope failure events can be recognised from the new data (Fig. 7). Flow types are varied and include debris avalanche, sediment slide and debris flow.

North flank of Tenerife

A huge amount of swath bathymetry, TOBI and Simrad EM 12 sidescan sonar and seismic profile data was collected over the north flank of Tenerife (Figs 8-10). Preliminary analysis of this data suggests that the landslide complex previously mapped in this area consists of the amalgamated deposits of at least three and probably four landslide events. For regional mapping purposes, the sidescan sonar data derived from the EM12 multibeam was found to be the best tool for the discrimination of the various landslide events. In this sidescan data, landslide deposits are clearly distinguished by their speckled high backscatter character. Differences in backscatter levels between landslide deposits of different ages can also be discerned (Fig. 9). Young landslides give the highest backscatter, while older landslides with thicker sediment cover give relatively lower backscatter. TOBI was used to map the structure and morphology of the various landslide deposits, concentrating on the most recent landslide event, correlated with the formation of the Icod Valley on Tenerife at about 170 Ka. The data from this landslide shows a largely chaotic breccia, with some evidence of channelised flow, linear longitudinal flow structures (shears?) and waves or pressure ridges of coarse debris (e.g. Fig. 10). Individual landslide blocks range up to about 2 km in diameter, but most are much smaller, in the tens to hundreds of metres size range. A downslope decrease in block size is apparent, although very large blocks appear to have a more random distribution. The Icod Debris Avalanche shows marked differences from the El Golfo Debris Avalanche off the island of El Hierro, mapped during RRS *Discovery* Cruise 205. The latter has the appearance of a true debris avalanche deposit, with a random scatter of blocks and no obvious flow structure. In contrast, the Icod deposit shows a considerably more organised flow structure, suggesting perhaps a flow process intermediate between avalanche and debris flow.

La Palma

Swath bathymetry data was collected on both the east and west flanks of La Palma (Fig. 11). A preliminary interpretation of the swath bathymetry and TOBI data from the western flank indicates a complex area of debris avalanche deposits incised by submarine canyons on the upper slope. On the lower slope, debris avalanche deposits give way downslope to a region of sediment failure scarps, in a sequence similar to that previously found off El Hierro (Fig. 12). However, these sediment features are largely buried, suggesting that they are considerably older than the 15,000 old features off El Hierro.

Swath bathymetry data from the eastern flank of La Palma indicate the presence of a previously unknown debris avalanche deposit. The complete extent of this deposit was not mapped, however, due to lack of time. The age of the deposit is not known.

El Hierro

Swath bathymetry coverage of the slopes of El Hierro was achieved to waterdepths of 3500 m or more all around the island. In addition to extending upslope the bathymetric coverage of the El Golfo failure (northwest side of the island) obtained on the Spanish vessel B. I. O. *Hesperides*, complete coverage of the El Julan embayment (southwest) and a previously unknown failure on the east side of the island was obtained (Fig. 13). TOBI data collected over the El Julan embayment (a supposedly 500, 000 yr old failure scar) showed a sequence of surprisingly fresh sediment failure scarps, but little evidence for any debris avalanche material. Further downslope to the southwest, the TOBI images show the Saharan Debris Flow deposit overlying a largely erosional seafloor. Areas of erosion are marked by strongly lineated downslope trending lineations (furrows?) and across slope scarps (Fig. 14).

REFERENCES

- Carracedo, J.C., Day, S.J., Guillou, H. and Gravestock, P.J. 1997. Geological map of Cumbre Vieja Volcano (La Palma, Canary Islands). Estacion Volcanologica de Canarias, La Laguna, Tenerife.
- Masson, D.G. 1996. Catastrophic collapse of the flank of El Hierro about 15,000 years ago, and the history of large flank collapses in the Canary Islands. *Geology* 24, 231-234.
- Masson, D.G. 1994. RRS *Discovery* Cruise 205. TOBI surveys and coring of debris flows west of the Canaries. IOSDL Cruise Report 239, 23 pages.
- Masson, D.G., Canals, M. Alonso, B., Urgeles, R. and Huhnerbach, V. in press. The Canary Debris Flow: source area morphology and failure mechanisms. *Sedimentology*
- Watts, A.B., Peirce, C., Collier, J. and Henstock, T. 1994. RRS *Charles Darwin* Cruise 82. Seismic reflection and refraction studies in the Canary Islands region.
- Watts, A.B. and Masson, D.G. 1995. A giant landslide on the north flank of Tenerife, Canary Islands. *J. Geophys. Res.* 100, 24,487-24,498.

Table 1. RRS Charles Darwin Cruise 108 : Dredge Stations

Dredge Number	Station Time		Ship Position		Estimated dredge position		Comment
	Outboard	Inboard	On bottom	Off bottom	On bottom	Off bottom	
CD108/1	0433/280	0740/280	0555/280 28° 38.71'N 16° 23.84'W	0704/280 28° 37.92'N 16° 24.25'W	0555/280 28° 39.0'N 16° 23.7'W	0704/280 28° 38.5'N 16° 24.0'W	Dredge and bucket filled with mud containing a few basalt fragments and bivalves. 2 ton weak link had parted, closing dredge bag
CD108/2	0905/280	1230/280	1049/280 28° 38.51'N 16° 24.81'W	1135/280 28° 38.23'N 16° 25.00'W	1049/280 28° 39.1'N 16° 24.5'W	1135/280 28° 38.7'N 16° 25.0'W	Dredge lost after only 4 ton pull. On recovery, the pennant was found to have parted, due to corrosion.
CD108/3	1313/280	1640/280	1442/280 28° 38.24'N 16° 24.70'W	1605/280 28° 38.45'N 16° 24.78'W	1442/280 28° 39.1'N 16° 24.3'W	1605/280 28° 38.6'N 16° 24.6'W	Dredge recovered before end of proposed track after becoming stuck on the bottom. Several basalt fragments, corals and bivalves recovered

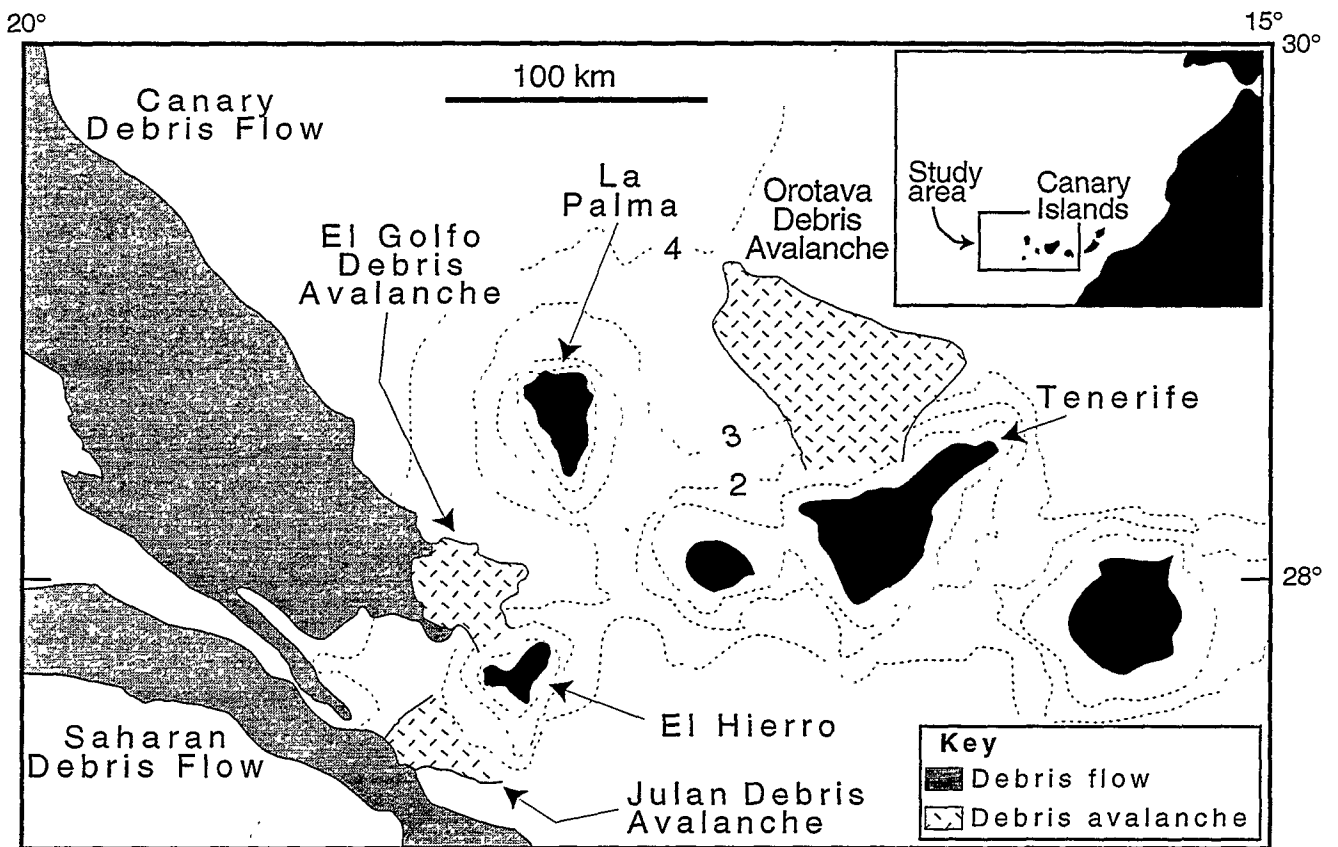

Figure 1. Location of the western Canary Islands. This figure shows the extent of slope failure deposits known (or suspected) prior to Charles Darwin Cruise 108.

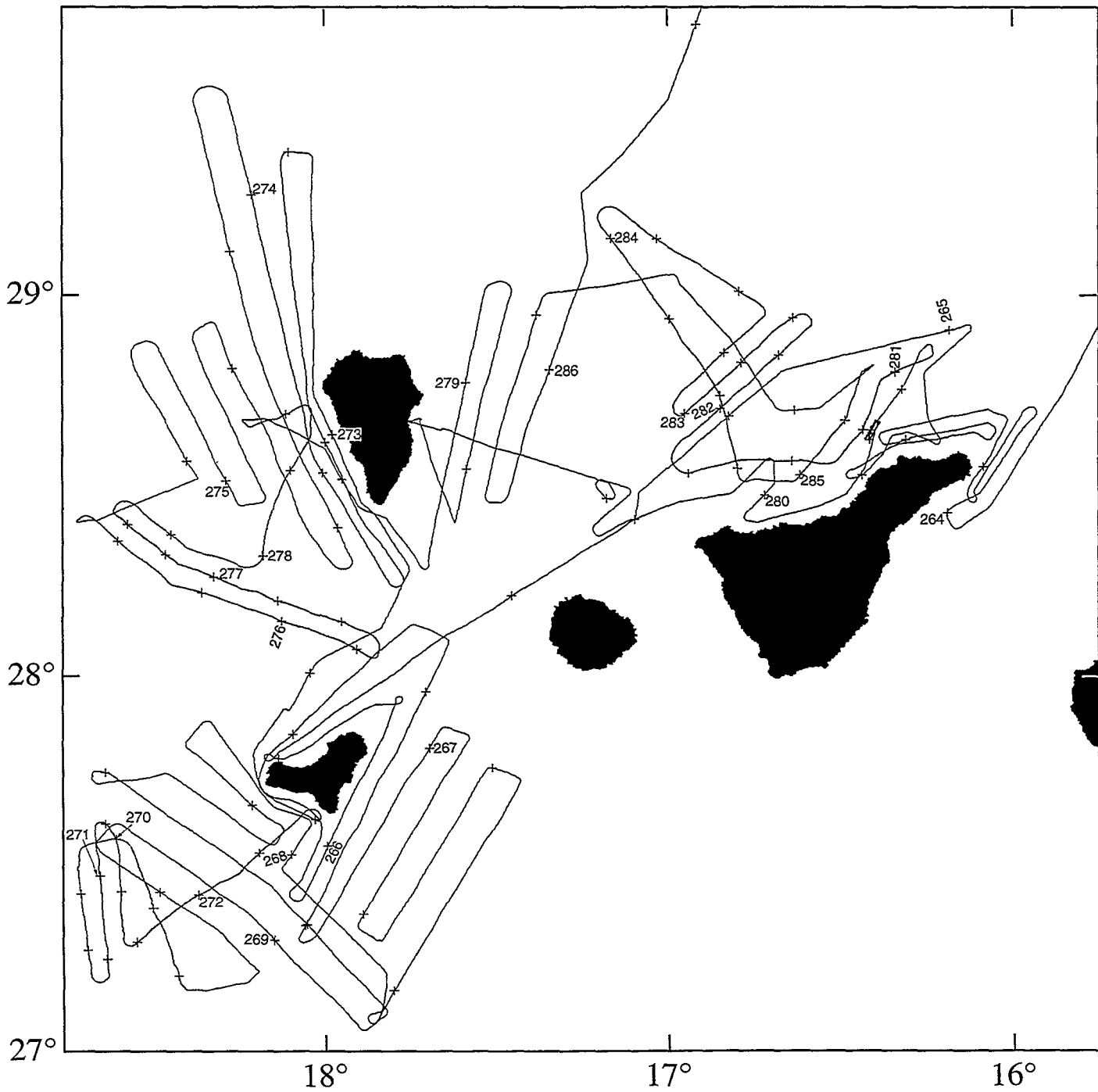

Figure 2. Summary track chart for RRS Charles Darwin Cruise 108. Annotations are day numbers at midnight; crosses on track are every 6 hours.

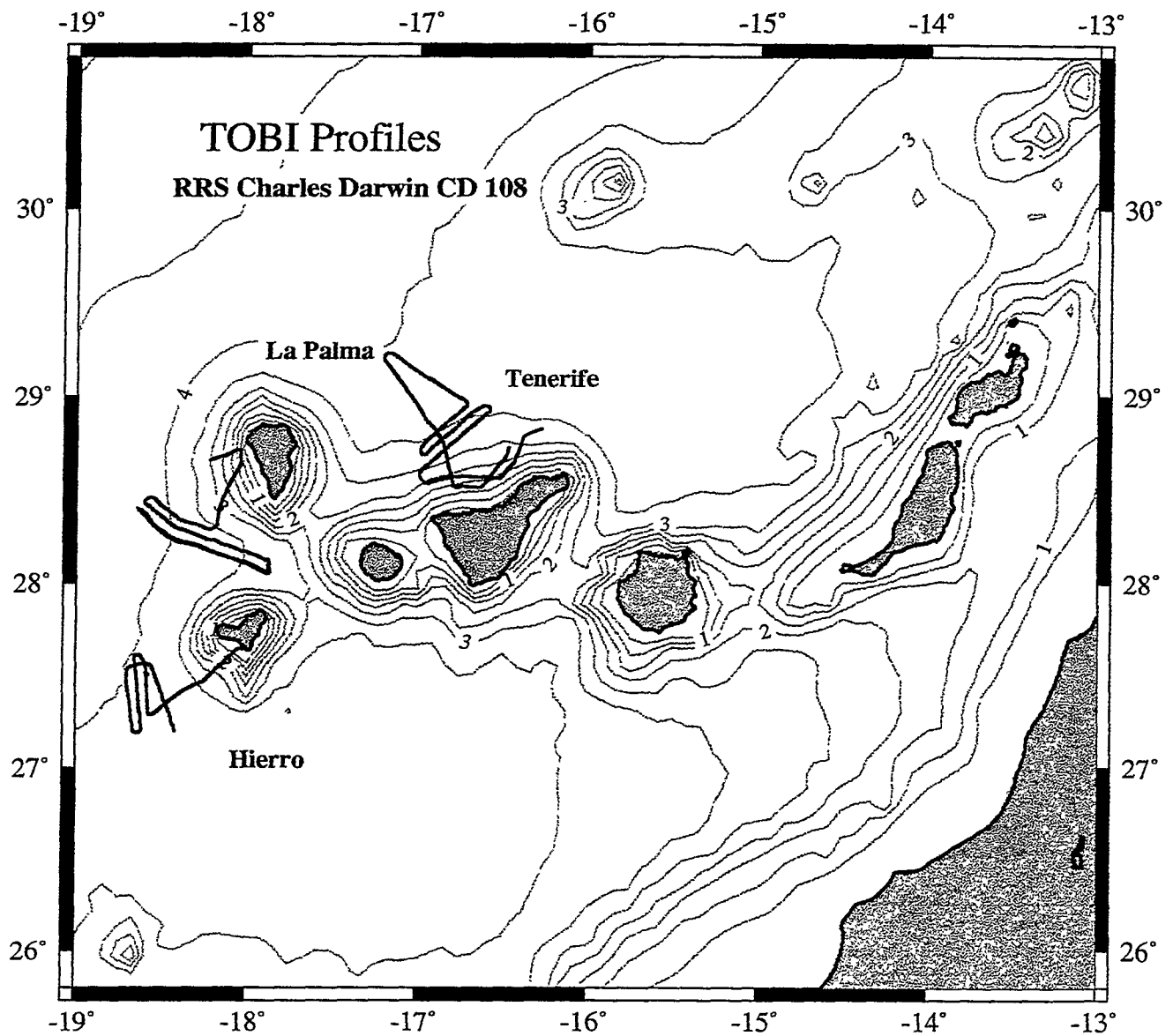

Figure 3. Tracks along which TOBI 30 kHz deep-tow sidescan sonar and 7 kHz profiles were obtained. Parallel tracks were generally run at a 5 km spacing to give marginally overlapping coverage.

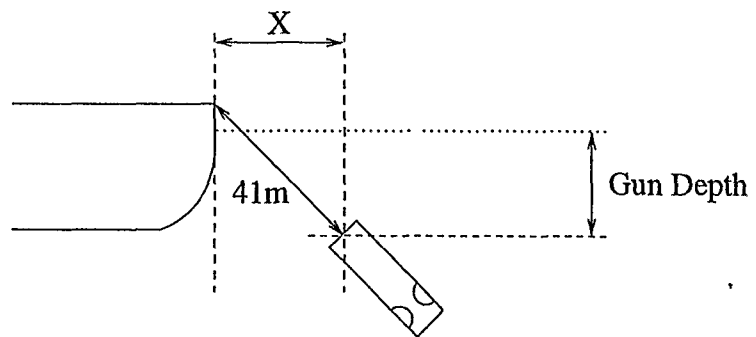
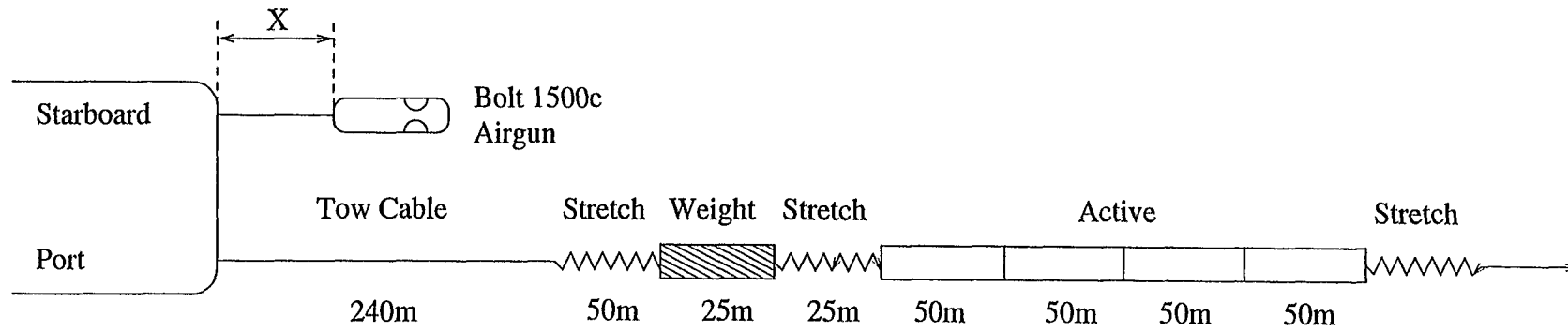

Figure 4. Geometry of airgun and streamer used during CD108

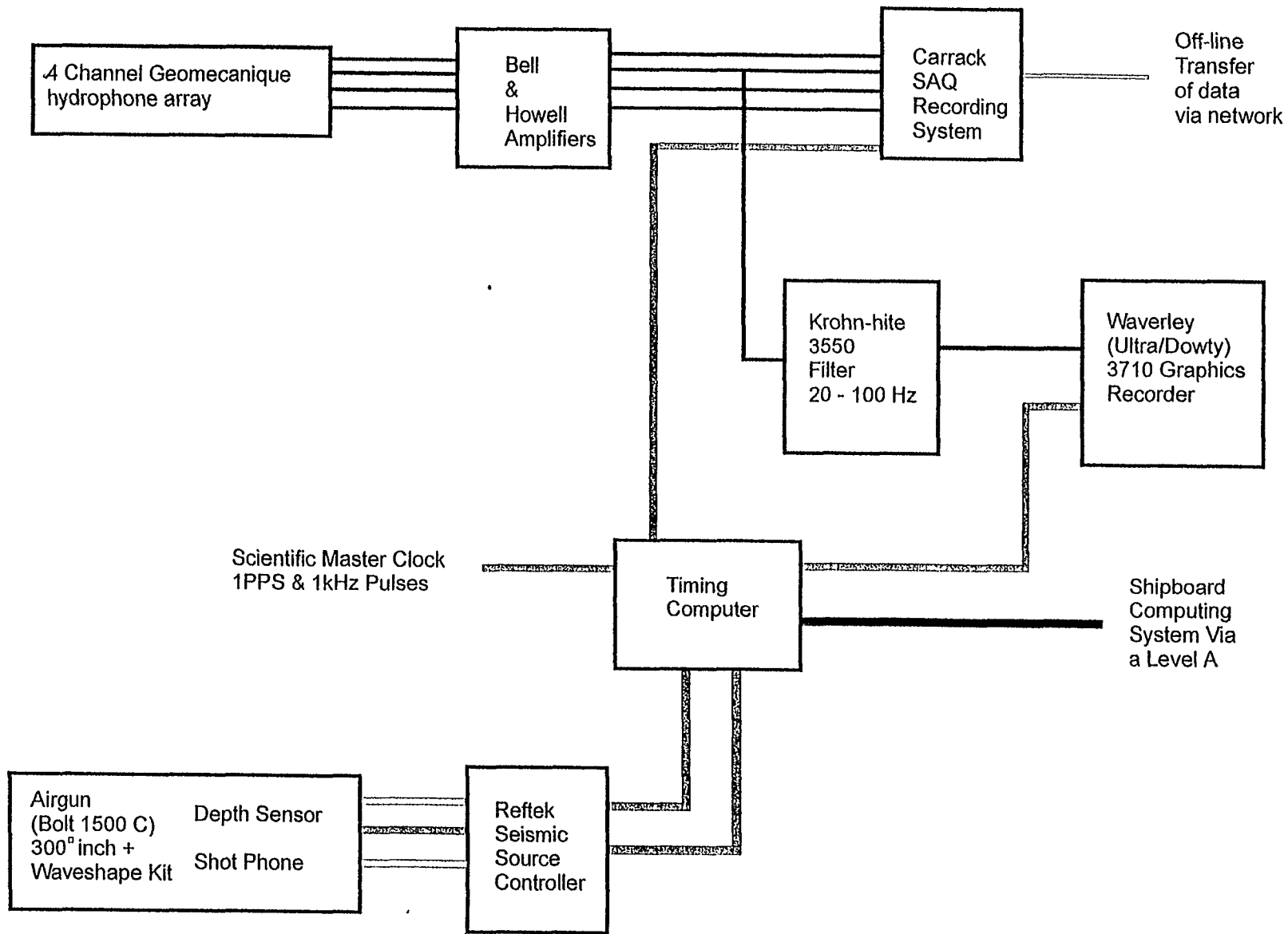

Figure 5. Block diagram of seismic recording system

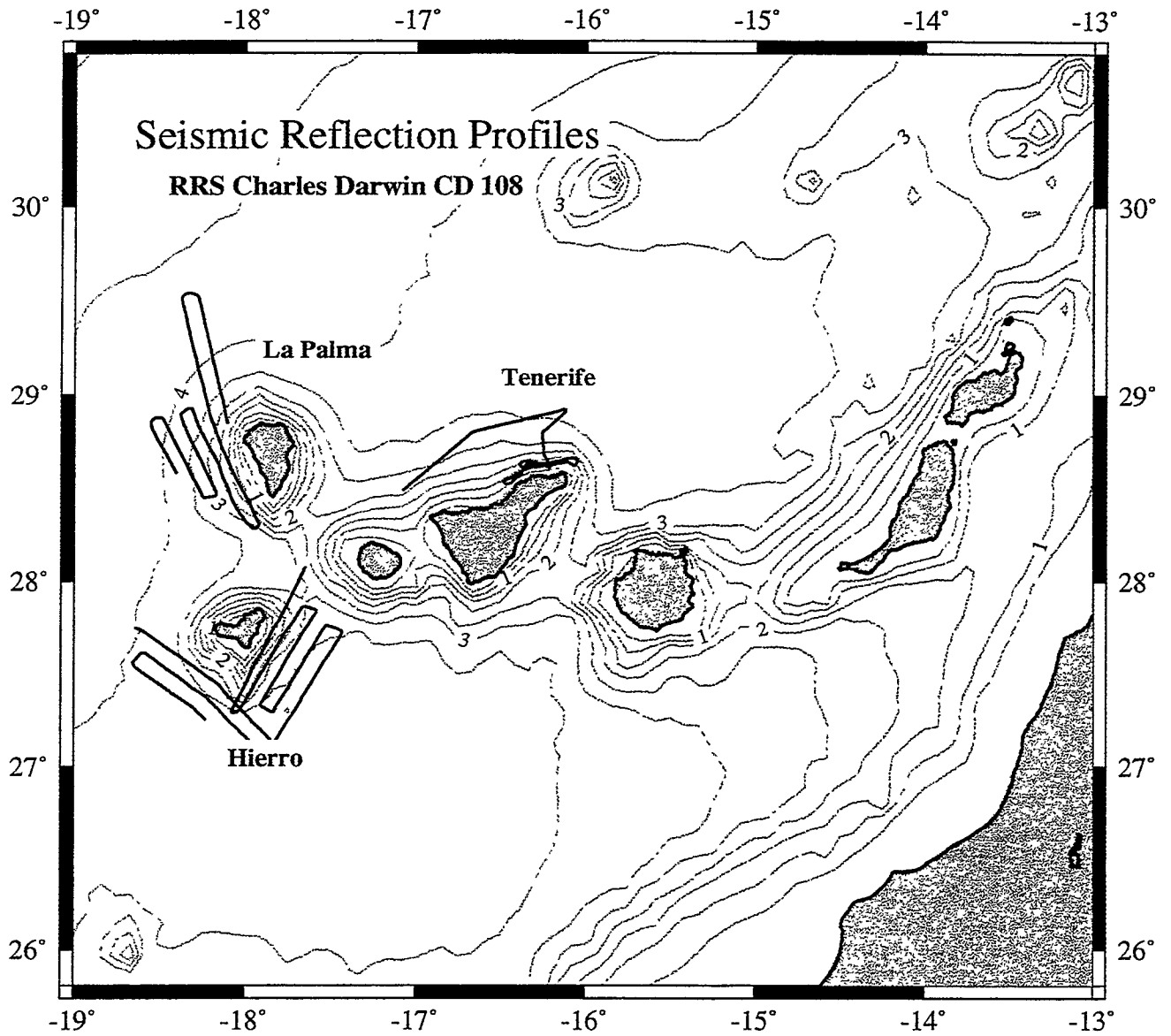

Figure 6. Tracks along which seismic reflection profile data were obtained.

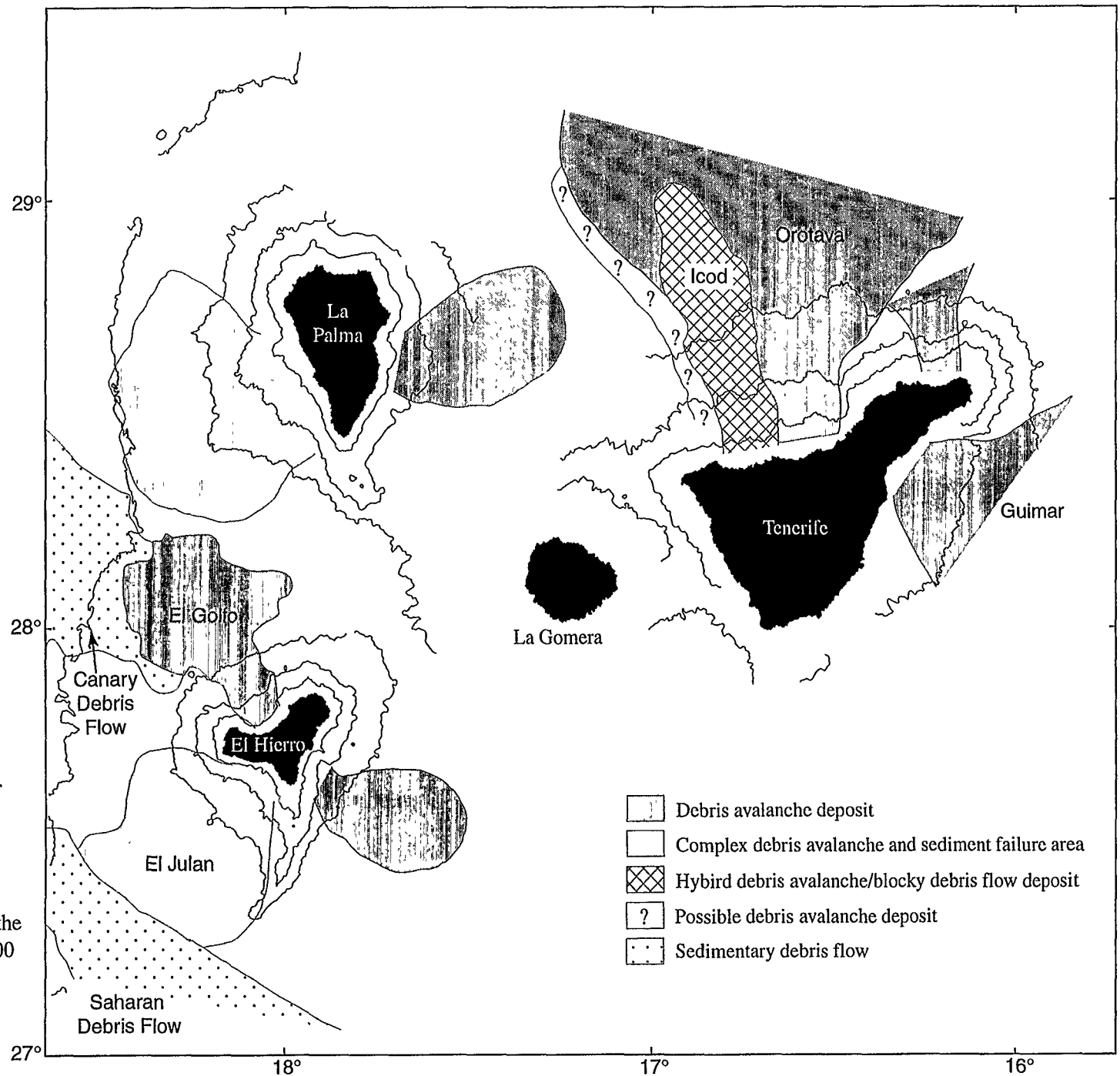

Figure 7. Preliminary interpretation of the areas affected by slope failure processes or buried by failure deposits. Previous interpretations (Watts and Masson, 1995; Masson, 1996) are included where appropriate. Landslide names are given where they exist. Contours, derived from the swath bathymetry survey, are shown at 1000 m intervals.

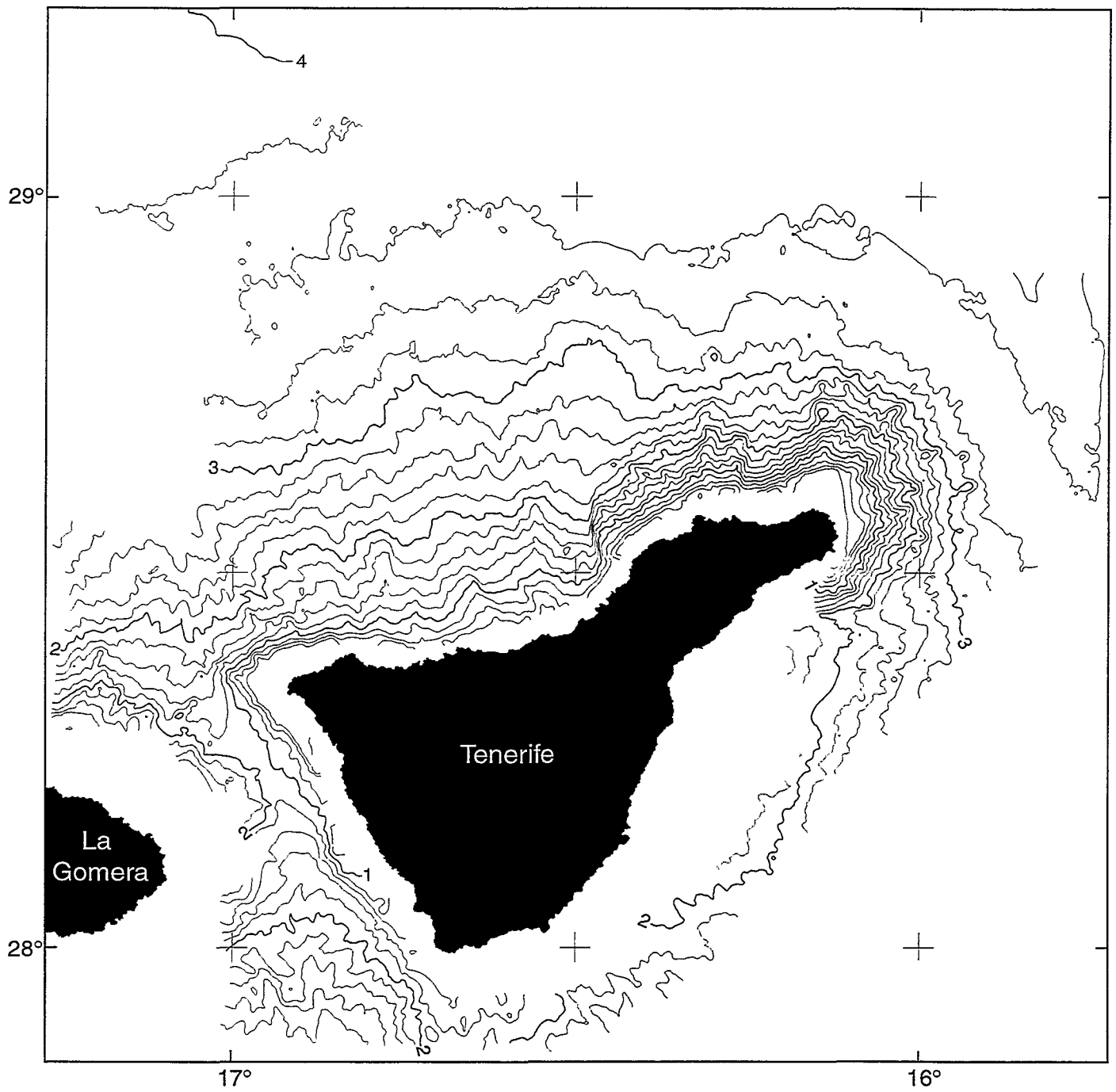

Figure 8. Summary of swath bathymetry data around Tenerife (includes data collected on RRS Charles Darwin cruise 82). Contour interval 200 m. Heavy lines are 1000 m contours.

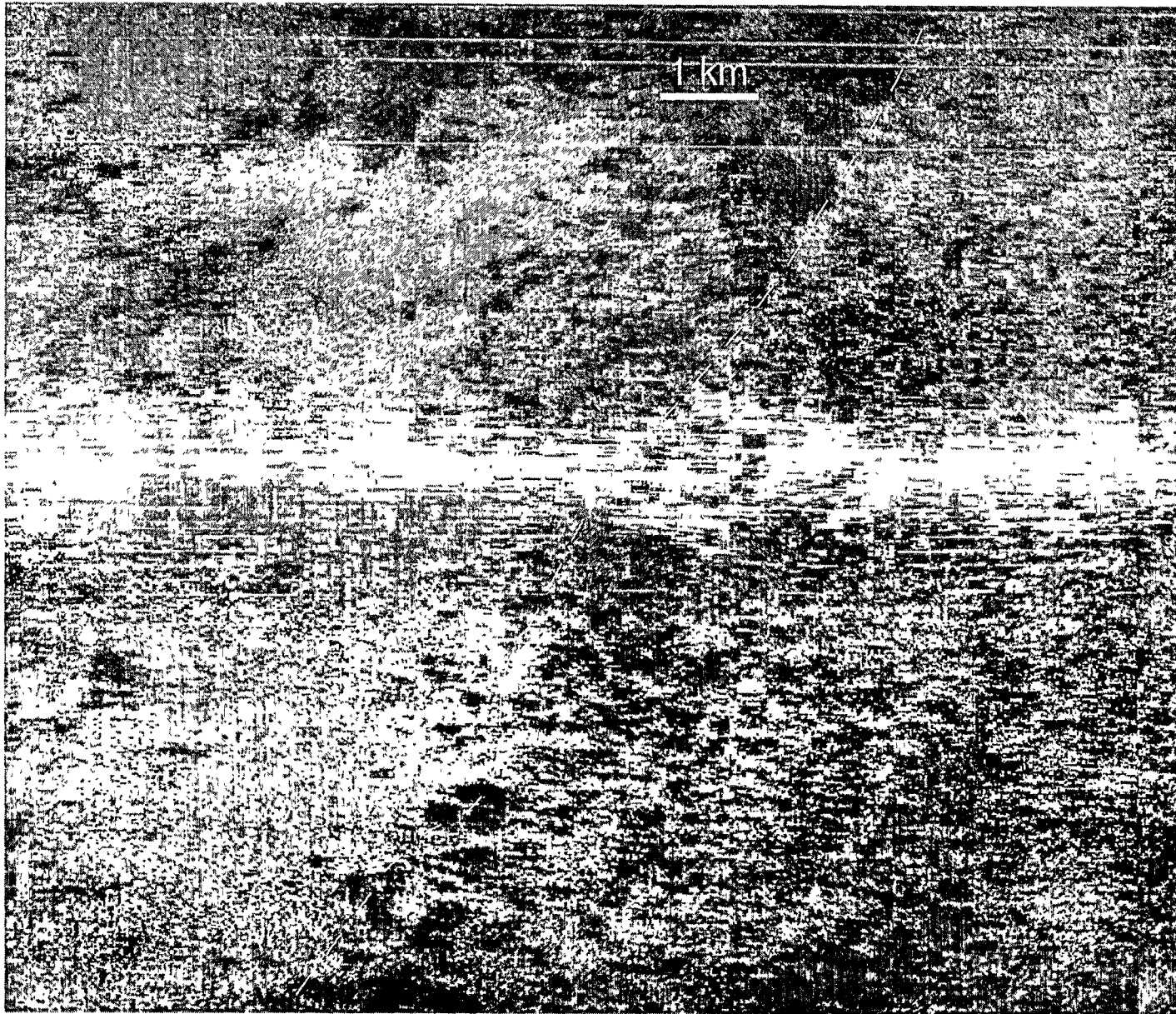

Figure 9. Example of backscatter data derived from EM12 multibeam data. High backscatter is black. Debris avalanche deposits have a distinctive speckly character in this data. It is also possible to distinguish between debris avalanche deposits of different ages, such as those which make up the debris avalanche complex on the north flank of Tenerife, because the backscatter is sensitive to the amount of sediment cover overlying each debris deposit. This example shows the boundary between the Orotava Debris Avalanche (about 400 ka age, left) and the much higher backscatter Icod Debris Avalanche (about 170 ka age, right).

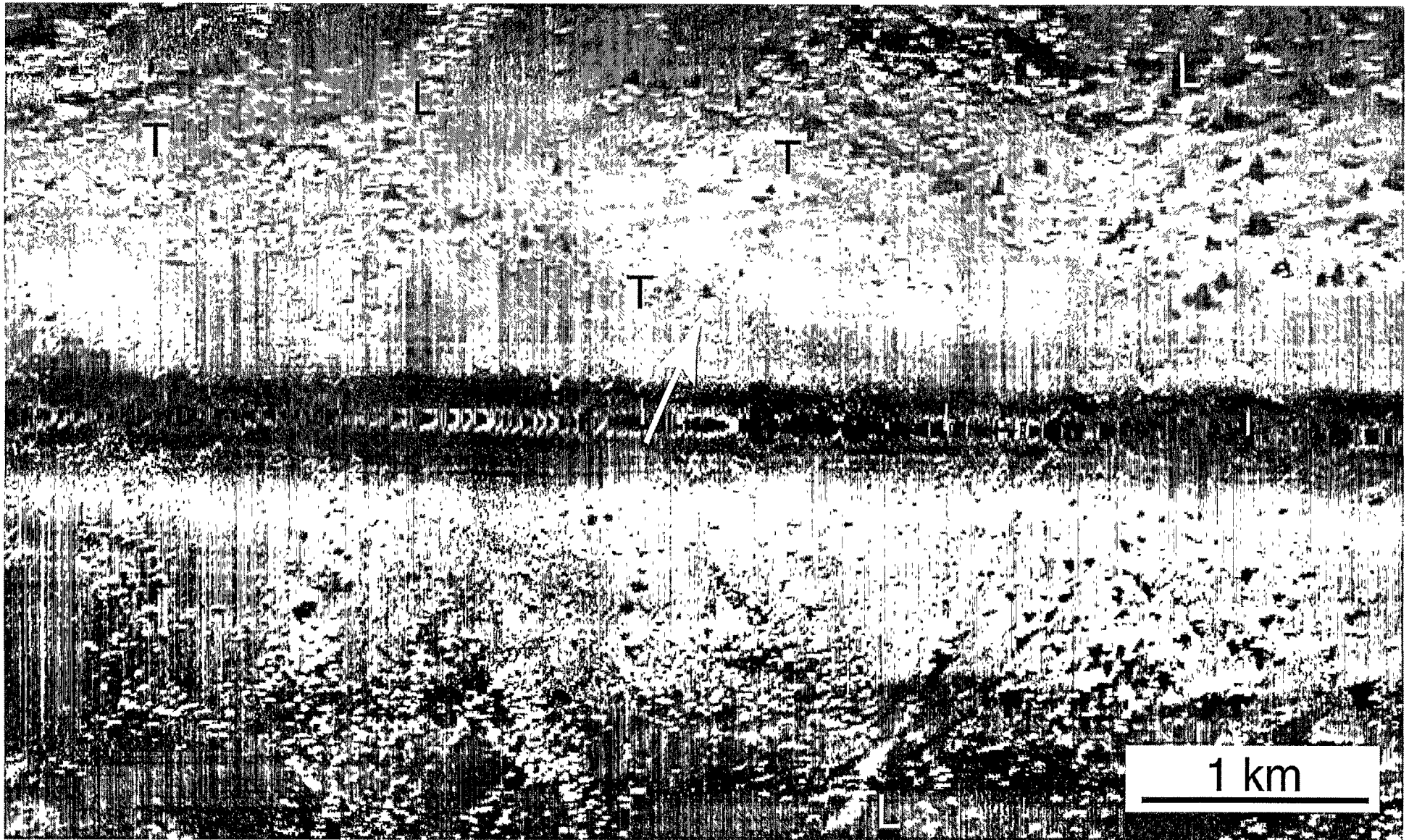

Figure 10. A TOBI sidescan sonar image showing the relatively fine-scale blocky character of the Icod Debris Avalanche. Both longitudinal (L) and transverse (T) structures are seen in this part of the avalanche. Arrow shows flow direction.

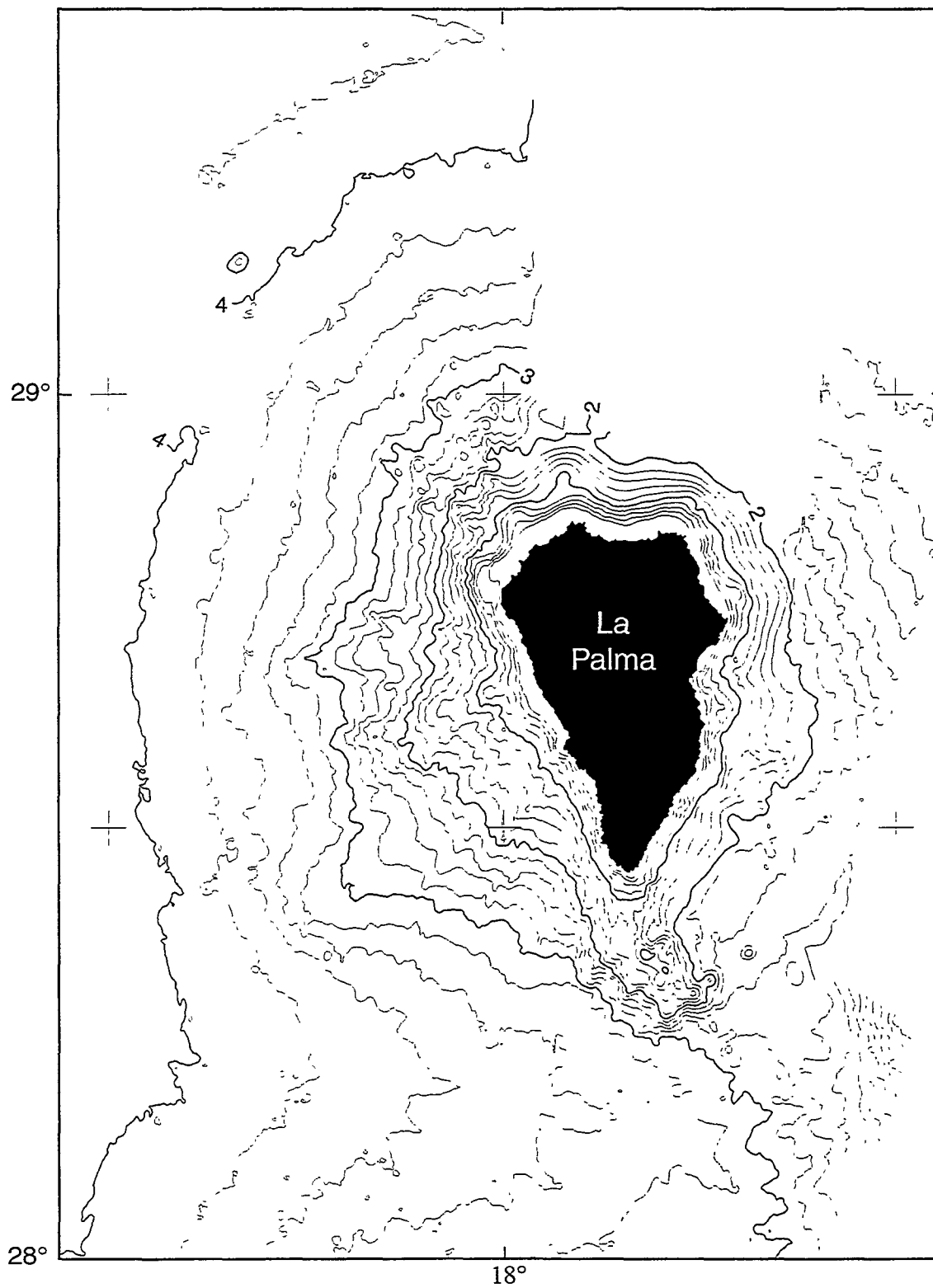

Figure 11. Summary of swath bathymetry data around La Palma (includes some data collected on B.I.O. Heperides Cruise Crescent-94). Contour interval 200 m. Heavy lines are 1000 m contours.

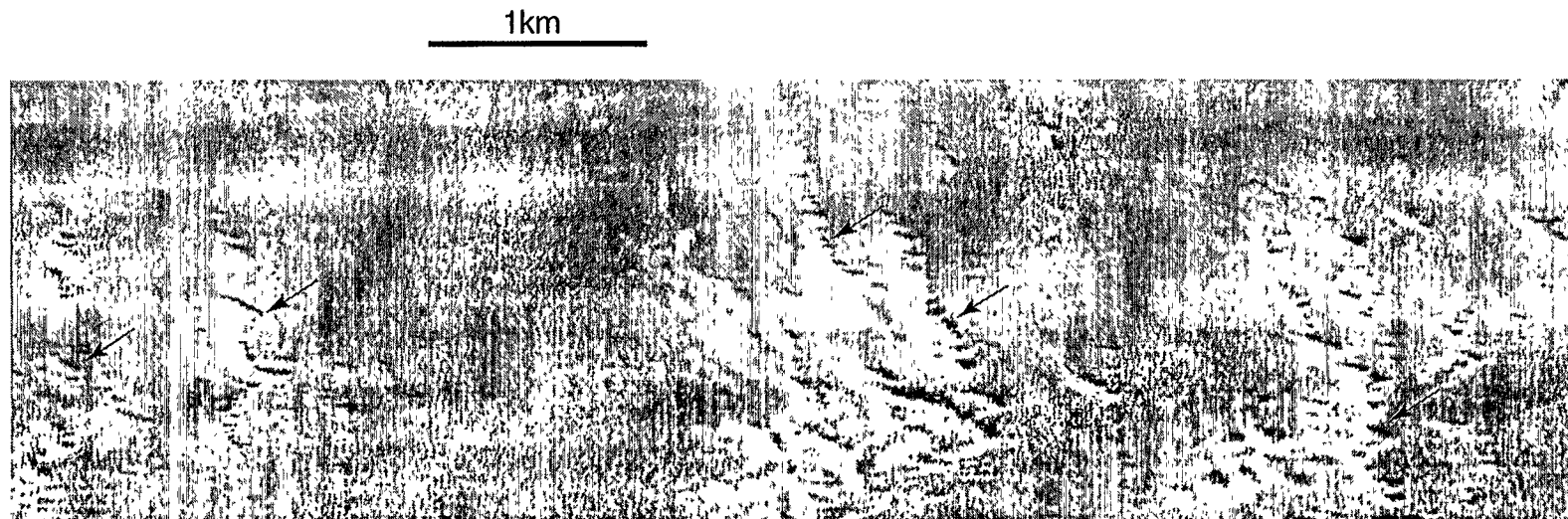

Figure 12. TOBI sidescan sonar image of a sequence of shallow rotational faults (examples arrowed) in the Canary Debris Flow headwall area southwest of La Palma. Downslope is to the left.

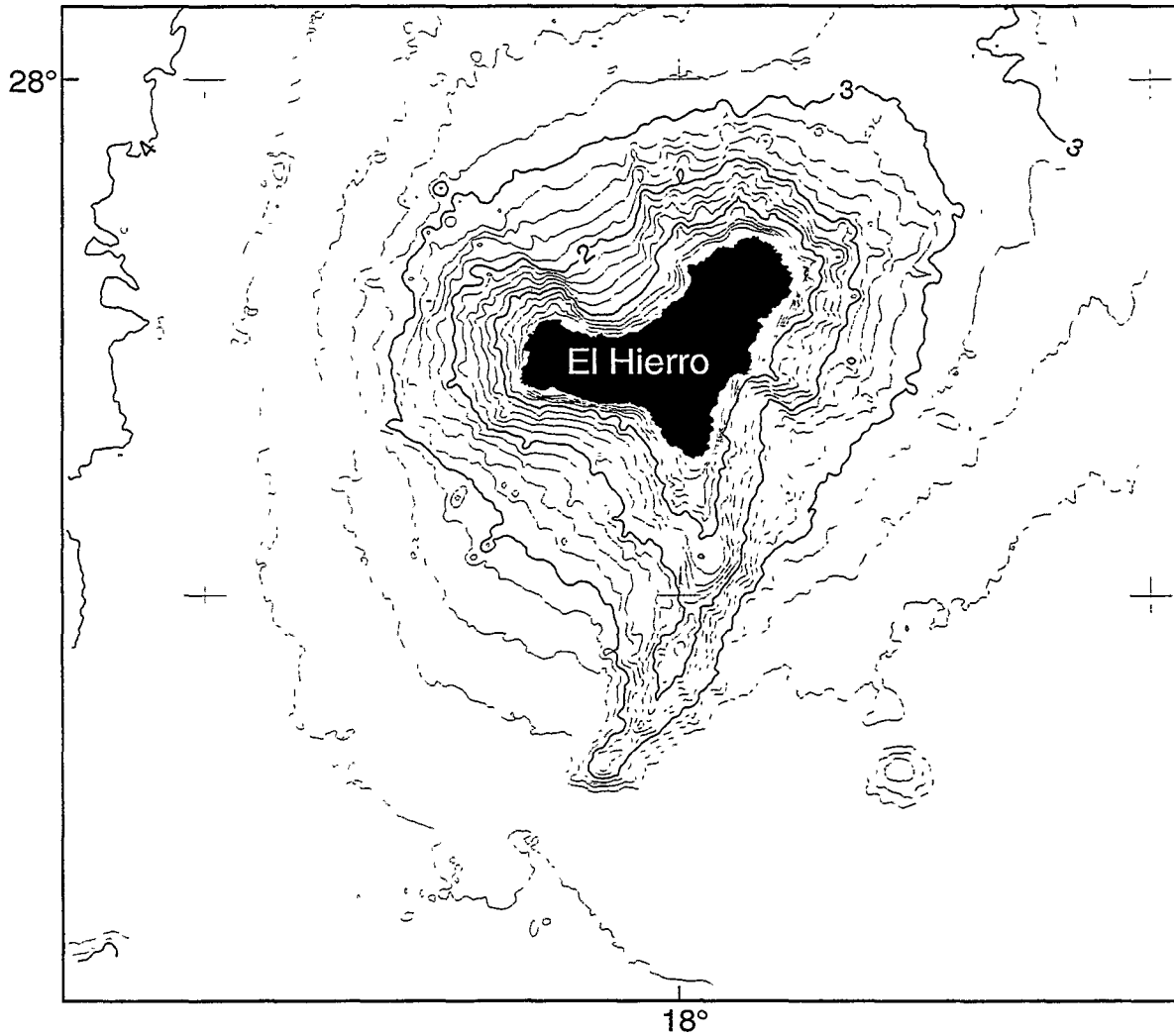

Figure 13. Summary of swath bathymetry data around El Hierro (includes some data collected on B.I.O. Heperides Cruise Crescent-94). Contour interval 200 m. Heavy lines are 1000 m contours.

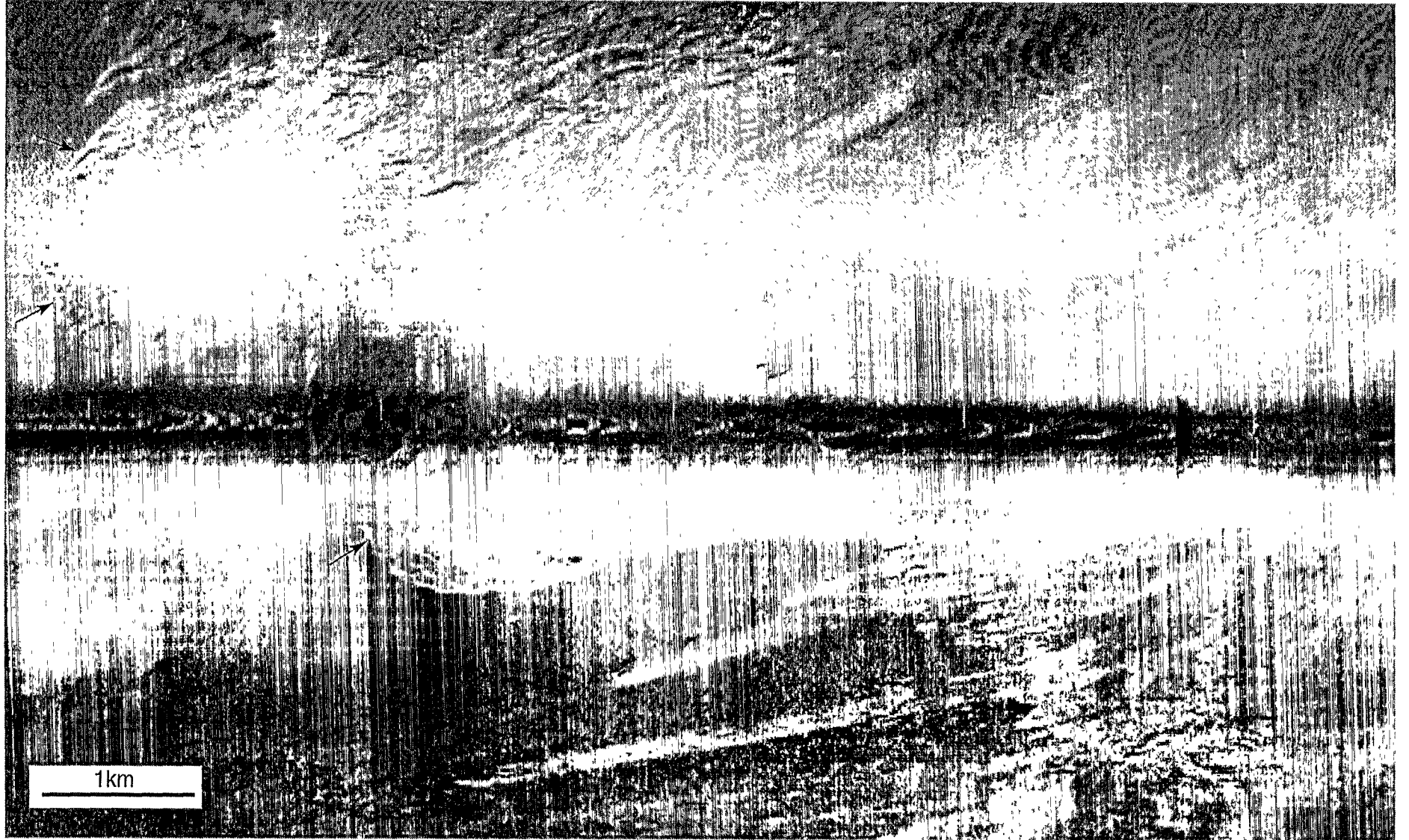

Figure 14. TOBI sidescan sonar image of an area of erosional scours south of El Hierro. Downslope is to the right. Unscoured seafloor is smooth and low backscatter (dark); scoured seafloor is rougher and has a highly variable but often high backscatter (light). In the upper part of the image, the area of scouring can be seen to have a distinct headwall scarp (arrows), but this is less clearly developed in the lower part.



**Southampton Oceanography Centre
European Way
Southampton S014 3ZH
United Kingdom
Tel: +44(0) 1703 596666
Fax: +44(0) 1703 596667**