



**National  
Oceanography Centre**  
NATURAL ENVIRONMENT RESEARCH COUNCIL

**National Oceanography Centre  
Cruise Report No. 57  
RRS James Cook Cruise JC165**

19 MAY - 12 JUNE 2018

Water column and seafloor time-series studies  
at the Porcupine Abyssal Plain Sustained Observatory

*Principal Scientists*

H A Ruhl

National Oceanography Centre, Southampton  
University of Southampton Waterfront Campus  
European Way  
Southampton  
Hants SO14 3ZH  
UK

Tel: +44 (0)23 8059 6365  
Email: [h.ruhl@noc.ac.uk](mailto:h.ruhl@noc.ac.uk)



## DOCUMENT DATA SHEET

<b>AUTHOR</b> RUHL, H A et al.	<b>PUBLICATION DATE</b> 2019
<b>TITLE</b> RRS <i>James Cook</i> Cruise 165 19 May - 12 Jun 2018. Water column and seafloor time-series studies at the Porcupine Abyssal Plain Sustained Observatory.	
<b>REFERENCE</b> Southampton, UK: National Oceanography Centre, Southampton, 158pp. (National Oceanography Centre Cruise Report, No. 57)	
<b>ABSTRACT</b> <p>RRS James Cook cruise 165 departed Southampton 19 May, operated in the Porcupine Abyssal Plain Sustained Observatory area (48°50'N 016°30'W) 22 May – 9 June, and returned to Southampton 12 June 2018. The overarching goal of the cruise was to continue various time-series observations of the surface ocean, water column, and seafloor at the site, as first studied by NOC (then the Institute of Oceanographic Sciences) in 1985. The specific objectives of the cruise were to recovery and redeploy, or service, three mooring systems (PAP1, PAP3, Bathysnap), and conduct a range of water column and seafloor observation and sampling operations. This cruise was a contribution to the Climate Linked Atlantic Section Science (CLASS) project supported by the UK Natural Environment Research Council (grant number NE/R015953/1).</p> <p>The PAP 1 mooring, a Met Office (Balmoral ODAS) buoy and Autonomous Sensor Platform (ASP) suspended 30 m below the surface buoy, was successfully, fully serviced, including replacement of the full ocean depth mooring on this occasion. The PAP 3 mooring, a sediment trap and current meter string, was successfully recovered and redeployed, including colonisation substrates and larval traps for the on-going LO3Cated (Larval Occurrences in Open Ocean: Connectivity studies in NE Atlantic and Mediterranean Sea) project. Unfortunately, the Bathysnap seafloor time-lapse camera mooring, and associated LO3Cated samplers, could not be recovered and is presumed lost (manual recovery may be attempted on a subsequent cruise, RRS Discovery cruise 103). Nevertheless, a replacement Bathysnap mooring with LO3Cated samplers was deployed. Two short-term (2-4 day) amphipod trap mooring deployments were also successfully carried out during the cruise.</p> <p>A series of water column observation and sampling operations were successfully carried out with a CTD instrument package and water bottle rosette, and vertically hauled zooplankton nets. The former including pre- and post-deployment calibrations of PAP 1 sensors. Seafloor sampling operations were successfully carried out with a Megacorer and otter trawl, yielding samples for a broad range of subsequent analyses (eDNA; prokaryotic and viral dynamics; biogeochemistry; microplastics; metazoan meiobenthos; macrobenthos; megabenthos; biochemistry and microbiome studies of selected megabenthic taxa). A programme of seafloor survey photography was also undertaken using the HyBIS vehicle, assessing the seafloor environment and associated fauna of the abyssal plain, a low abyssal hill, and the summit of a seamount ("Ben Billett"). A series of Megacorer samples were also successfully recovered from the abyssal hill location.</p> <p><b>KEYWORDS</b>          Amphipod trap, Bathysnap, Benthic communities, Biochemistry CTD, HyBIS, Hydrography, James Cook/RRS – cruise (2018) (165), Porcupine Abyssal Plain, Macrofauna, Megacorer, Megafauna, Meiofauna, Nutrients, Ocean observation, Otter trawl, Photography, Prokaryotes, Sediment trap, Zooplankton</p>	
<b>ISSUING ORGANISATION</b> <b>National Oceanography Centre</b> <b>University of Southampton Waterfront Campus</b> <b>European Way</b> <b>Southampton SO14 3ZH</b> <b>UK</b> Tel: +44(0)23 80596116 Email: nol@noc.soton.ac.uk A pdf of this report is available for download at: <a href="http://eprints.soton.ac.uk">http://eprints.soton.ac.uk</a>	

*(This page intentionally left blank)*



## Contents

<b>Sections</b>	<b>Page</b>
<b>1. Personnel</b>	<b>6</b>
<b>2. Itinerary</b>	<b>8</b>
<b>3. Objectives</b>	<b>9</b>
<b>4. Narrative</b>	<b>10</b>
<b>5. NMF technical report introduction</b>	<b>14</b>
<b>6. Mooring operations</b>	<b>17</b>
<b>7. CTD systems</b>	<b>28</b>
<b>8. HyBIS system</b>	<b>33</b>
<b>9. Other NMF equipment</b>	<b>52</b>
<b>10. Scientific ship systems</b>	<b>53</b>
<b>11. PAP1 - Observatory scientific report</b>	<b>57</b>
<b>12. PAP3 - Sediment traps scientific report</b>	<b>112</b>
<b>13. Zooplankton nets</b>	<b>115</b>
<b>14. Benthic systems and sampling</b>	<b>117</b>
<b>15. FixO<sup>3</sup>-TNA project LO<sup>3</sup>CAted</b>	<b>147</b>
<b>16. Acknowledgements</b>	<b>152</b>
<b>17. Station list</b>	<b>153</b>

## 1. Personnel

### Scientific personnel

Ruhl, Henry (Principal Scientist) - NOC, Ocean Biogeochemistry & Ecosystems  
Ballinger, Thomas - NOC, National Marine Facilities  
Barone, Giulio - Polytechnic Uni. of Marche, Department of Life and Environmental Sciences  
Benoist, Noelle - University of Southampton, Ocean and Earth Science  
Bett, Brian - NOC, Ocean Biogeochemistry & Ecosystems  
Biede, Virginia - University of Southampton, Ocean and Earth Science  
Camargo, Carolina - Partnership for Observation of the Global Ocean, Ocean Training Partnership  
Campbell, John - Campbell Ocean Data  
Cardwell, Christopher - NOC, Ocean Technology and Engineering Group  
Carugati, Laura - Polytechnic Uni. of Marche, Department of Life and Environmental Sciences  
Childs, David - NOC, National Marine Facilities  
Comben, Daniel - NOC, National Marine Facilities  
Darlington, Eleanor - NOC, National Marine Facilities  
Gana, Amine - NOC, Ocean Technology and Engineering Group  
Génio, Luciana - University of Aveiro, Department of Biology  
Hartman, Susan - NOC, Ocean Biogeochemistry & Ecosystems  
Hollingsworth, Anita - University of Southampton, Ocean and Earth Science  
Locke, Russell - NOC, National Marine Facilities  
Miskin-Hymas, Charlotte - NOC, British Oceanographic Data Centre  
Pebody, Corinne - NOC, Ocean Biogeochemistry & Ecosystems  
Pfeifer, Simone - University of Southampton, Ocean and Earth Science  
Rundle, Nicholas - NOC, National Marine Facilities  
Sherring, Alan - NOC, National Marine Facilities  
Viera Rivero, Josue Daniel - NOC, National Marine Facilities  
Ward, Juan - NOC, National Marine Facilities  
Whittle, Stephen - NOC, National Marine Facilities  
Young, Rob - NOC, Ocean Biogeochemistry & Ecosystems

### **Ship's personnel**

Leask, J.A.	Master
Voaden, E.R.	C/O
Graves, M.H.	2/O
Hoxby, S.	3/O
Fleming, H.F.	Cadet
Reid, A.G.	Cadet
Sneddon, K.	C/E
Porelli, L.N.	2/E
Nicholson, G.	3/E
Macneil, A.	3/E
Carnaffin, C.M.	ETO
Howard, C.J.	PCO
Minnock, M.	CPOS
Lewis, T.G.	CPOD
Day, S.P.	POD
MacDonald, R.P.	SG1A
Reynolds, J.	SG1A
Riley, K.P.	SG1A
Mackenzie, D.	SG1A
Caines, D.A.	H/Chef
Keighley, C.B.	Chef
Robinson, P.W.	Stwd
Mason, K.J.	A/Stwd

## 2. Itinerary

Sail NOC, Southampton, UK 19 May 2018

Operations at the Porcupine Abyssal Plain Sustained Observatory, 22 May – 9 June 2018

Dock NOC, Southampton, UK 12 June 2018

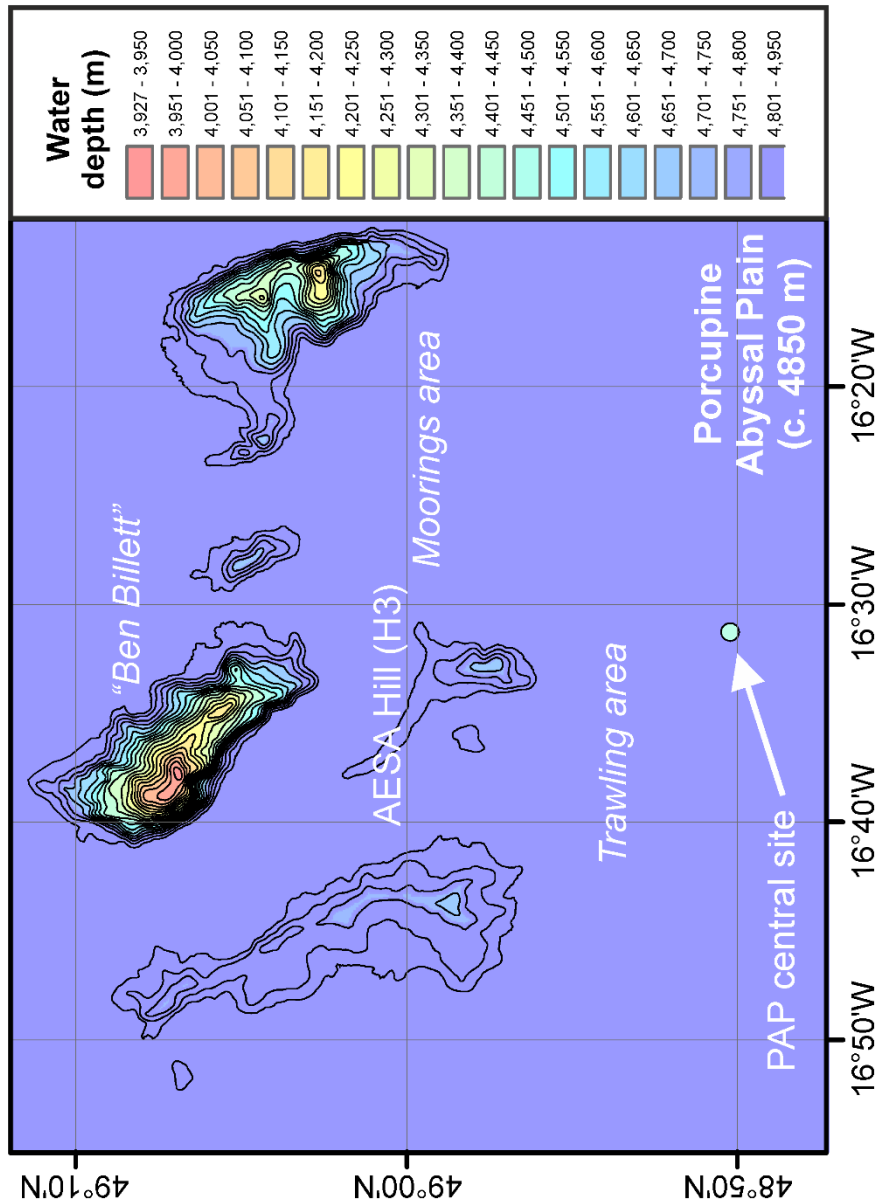

*General chart of the Porcupine Abyssal Plain Sustained Observatory operations area for RRS James Cook cruise 165, indicating selected locations referred to in this cruise report.*

### **3. Objectives**

The overarching goal of RRS *James Cook* cruise 165 was to continue various time-series observations of the surface ocean, water column, and seafloor at the Porcupine Abyssal Plain Sustained Observatory site, as first studied by NOC (then the Institute of Oceanographic Sciences) in 1985. The specific objectives of the cruise were to recovery and redeploy, or service, three mooring systems (PAP1, PAP3, Bathysnap), and conduct a range of water column and seafloor observation and sampling operations.

## 4. Narrative

The mobilization for the cruise in Southampton went well and all materials were loaded by the afternoon of Friday 18 May 2018. We departed for PAP-SO at 10:00 (BST) Saturday 19 May. By Monday 21 May we shifted the ship's clock from BST to UTC (GMT) and reached abyssal depths mid-morning and began to stream the newly mounted CTD wire. This process was finished by 16:00 and we restarted our transit to PAP-SO.

We reached the PAP-SO PAPI buoy about 06:00 and it appear to be in good condition riding reasonably high in the water with no visible damage apart from one met sensor slightly off vertical on the top of the mast outer ring. With the CTD termination having set over night we began final preparations of the CTD system including load testing the termination and adding a swivel into the arrangement.

While the final CTD preparations were done, we moved to the Bathysnap position to recover it (Station DY077-084). We made several attempts using the ships transducer, as well as two deck units and were unable to establish communication or receive any indication of its presence. The release command was given many times beginning at 07:38 and several stood watch on the bridge with binoculars during and well after its expected surface time. The reasons for the apparent failure of the release might be related to a manufacturing issue with the camera housing, which could have cascaded to failure of the release.

CTD operations were started in the vicinity of the Bathysnap position for system testing, instrument calibration, and eventually a deep CTD cast. The initial test cast was ended by the failure of the main swivel, which also drained its housing oil. The system was re-rigged without the swivel in place and a second deployment worked effectively. The CTD was then cleaned and sensors for calibration added for a shallow cast. Megacoring began in the evening with two good recoveries overnight.

23 May - The PAPI top end was recovered to deck and the lower end stopped off with a temporary buoy. The system was in overall good condition. However, the load cell appears to have damaged the wiring and instruments on the sensor frame. The anemometer on the met station mast was over at about 45 degrees from vertical. A deep CTD cast was done next. The swivel was removed for a deep cast for testing releases, lab on chip sensors, and deep-water collection.

24 May – The HyBIS system was launched just after 08:00 and at the seafloor at about 10:20. During the descent one of the lamps went out, as did the upward-looking camera, the pressure sensor and altimeter. The dive proceeded with the main camera still functional and repairs were initiated after the dive. Overnight the coring wire was having scrolling issues on recovery at about 850 metres of wire out (mwo). This hampered both Megacore recoveries overnight and required intervention in the winch room.

25 May – A shallow calibration CTD cast was conducted in the early morning including sensors from the recovered PAP1. This was followed by deployment of PAP3. An issue with one of the sediment trap battery packs was discovered where it was found to be unexpectedly drained. This was inspected and a loose wire fitting was identified, and the battery replaced prior to deployment. The charge was checked again prior to deployment and found to be full after an overnight checking period. Two Megacores were done overnight.

26 May – After the second overnight Megacore was completed, a HyBIS dive was completed. Then two additional Megacores were conducted overnight.

27 May – PAP3 DY077-040 released its ballast around 07:00 and the top floats were at the surface within 45 minutes. The dan buoy was tangled amongst the first float package and was broken off between its lower mast and floatation. The top three traps came aboard well. The bottom trap was tangled and the line was cut in several places while both the remaining float rack and release, as well as the trap lines were stopped. All remaining components were eventually recovered, and the samples looked good with modest fluxes over the deployment. Two daytime zooplankton net deployments were done and the amphipod trap was deployed. We then conducted two CTDs, one shallow and one deep. Two Megacores were done overnight.

28 May – Overnight, Megacoring was slowed considerably by scrolling issues. HyBIS went in after breakfast, but the deployment was soon aborted as the telemetry feed did not start when the high voltage system was switched on. The team did some troubleshooting and located a frayed fibre, which was fixed and the system was at the seafloor just after mid-day. Overnight, Megacore station CC13 was sampled but the scrolling issue experienced in earlier deployments was worsening with the wire having to be spooled back out and in over a period of an extra 4 hours compared to a typical deployment.

29 May – The morning found us in thickening fog, delaying the release of the amphipod trap. Fog cleared by 09:00 and the trap ballast was released. The system was on the surface shortly after 11:00 and recovered to deck just after noon. We then conducted a pair of daytime zooplankton nets followed by a deep CTD. The general purpose winch continued to have scrolling issues adding several hours to the coring work overnight.

30 May – The Megacore was recovered to deck around 08:00 and we then began preparations for HyBIS deployment. Given the GP winch scrolling issues, it was decided to use the trawl wire for Megacore work. This had been done on DY077 with good effect. The HyBIS deployment went well apart from an increase in heave; with two transect lines achieved and a sufficient number of images now taken in the PAP central area. PAP1 software testing was completed in the evening and the final assembly process had begun. The use of the trawl wire for coring revealed scrolling issues with this winch as

well, which were resolved with the replacement of a blown fuse and re-alignment of the scrolling positions.

31 May – The HyBIS deployment was delayed by a re-termination of the fibre optic cable. We were able to run two lines in the H3 area once the system was up and running again. We then proceeded to Megacoring on the trawl wire overnight.

1 June – The use of the trawl wire for Megacoring worked well. The amphipod trap was deployed in the morning followed by a shallow and then deep CTD cast for calibration and sampling. By the evening, the weather was building and we decided to move about 50 nm to the NE, into the eye of the weather system to avoid the worst wind and seas.

2 June – As the weather system passed overnight we stayed to the NE of the PAP-SO and gradually began moving back in the morning. This move enabled us to avoid the worst of the weather and leave deck conditions workable for final assembly of the PAP1 mooring. Once back on station in the early evening we began Megacoring with a mid-night set of zooplankton nets. Another Megacore was then done.

3 June – Final electronic connections were made on PAP1 and it began a period of full testing, telemetering back to NOC. We started a HyBIS dive in the morning that was then followed by a Megacore deployment.

4 June – The PAP1 overnight testing went well and the system was ready to deploy at 08:00. The deployment went very well with no major issues arising. The new winch for the main rope performed well, although the scrolling had to be manually cued to switch direction at the right time. The anchor was released at about 14:43 and the anchor position calculation began once the system was thought to have reached the seabed. We then moved to restart Megacoring overnight with the final zooplankton nets occurring around midnight.

5 June – We released and recovered the amphipod trap first thing in the morning. We then repositioned to recover the old PAP1 mooring line deployed on FS *Meteor* cruise M108. The recovery went well and the lines were all aboard by 14:00. It was a good performance of the acoustic release system, which had been deployed for 4 years. With the PAP mooring line recovery going very well, we opened up enough time in our schedule to revisit the Bathysnap location and try another release. Unfortunately, after doing another set of blind releases and waiting well past the prospective surfacing time, there was no sign of it. In the evening, we moved to a location NW of PAP-SO to deploy the OTSB, in a SE direction overnight.

6 June – The trawl was recovered in good condition mid-morning. The catch was light and generally free of mud. The trawl processing took about 5-hours with several specialised sampling approaches



being done. We then moved to the H3 area for a HyBIS deployment. The deployment went well and we achieved three lines of the fine scale grid. We then resumed Megacoring overnight.

7 June – The coring overnight went very well with 8/8 core tube retrievals on each of two drops. We deployed Bathysnap before breakfast and then moved to triangulate its position, as well as that of PAP3. A shallow CTD was conducted for calibration of the Star-Oddi temperature loggers, followed by a deep cast for a final trial of the lab-on-chip nutrient sensors.

8 June – The final two Megacores were conducted overnight on the H3 hill slope. We then started a HyBIS dive down the lower slope of the northern side ending on the abyssal plain. We streamed the video live to the internet with >500 viewers watching. We then moved to another trawl, again off to the west of our normal working area, where we could this time run south to north.

9 June – The trawl came on deck around 08:00 and was a larger catch than the first, but still without much mud. The samples were processed throughout the day and included a sample request that came in as a result of the live streaming the day before. We then moved to survey the western flank and top of 'Ben Billett' (named for our colleague Dr David S.M. Billett), a seamount in the northern part of the PAP study area. The survey revealed some rock outcrops, steep faces and higher abundances of filter feeders on the upper areas than on the steep slopes and plain. With the survey finishing at 14:30 we then moved to make preparations for the passage to Southampton.

**HAR**

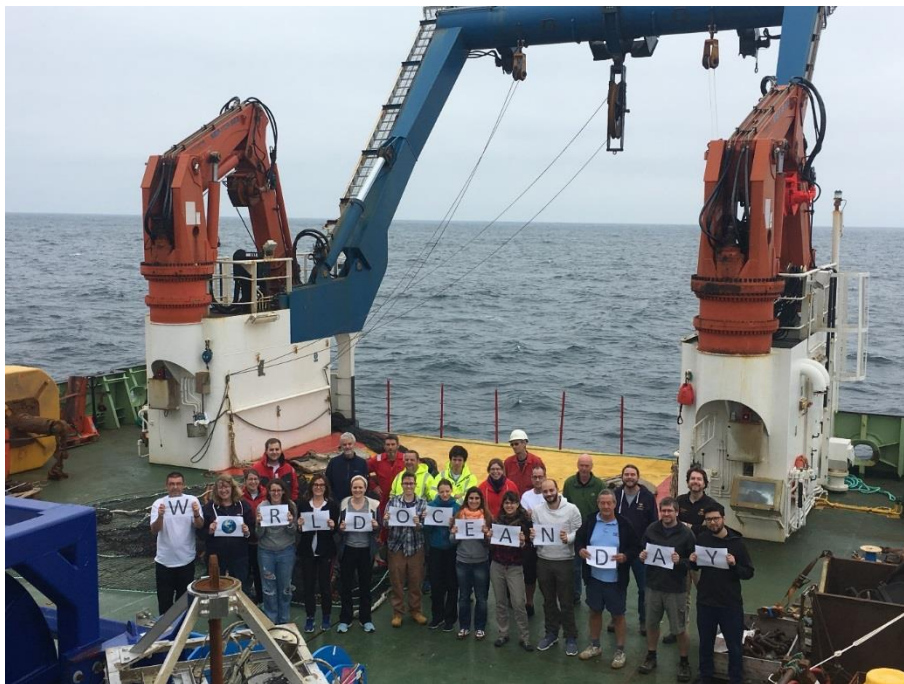

*8 June 2018 – World Oceans Day aboard RRS James Cook cruise 165*

## 5. NMF technical report introduction

### Technical Team

Sensors & Moorings	Dave Childs	CTD Pilot
	Tom Ballinger	Trainee CTD Pilot
	Steve Whittle	Moorings Coordinator
	Nick Rundle	Senior Technical Officer
MARS	Russell Locke	HyBIS Pilot
	Josue Viera	HyBIS Pilot
Ship Systems	Juan Ward	Engineering Manager
	Ella Darlington	Technician
Ocean Engineering Group	Allan (Iceman) Sherring	Team Leader
	Dan Comben	Project Manager/Technician

### NMF systems introduction

This year's PAP cruise has been predominantly benthic investigations with interludes of moorings activities and nets. Many of the usual scientists and associated equipment deployed on the PAP research cruise have been utilised for the COMICS cruise off Namibia on DY90. The main foci for the NMF technical team have been to turn around the PAP 1 and PAP 3 moorings, with supporting CTD calibration deployments, deploy HyBIS for benthic HD digital film and stills grid work, deploy and retrieve amphipod traps, turn around Bathysnap and support trawling, nets and coring as needed. The individual group reports for each technical discipline are collated in this report.

### Moorings

The PAP 1 mooring is a collaboration between four organisations, NMF, OBE, The Met Office and OTEG. Overall design, development and deployment of the physical system is the responsibility of the Sensors and Moorings (S&M) team within the National Marine Facilities (NMF) group. The surface buoy (a Balmoral ODAS buoy) complete with meteorological sensors is currently supplied by the Met Office. Ocean Technology and Engineering Group (OTEG), with extensive support from Campbell Ocean Data (COD), look after the Electronics and communications hub and real time data stream as well as occasional trial sensor deployments. The specifications and scientific data are provided by and for the customer: NOC DST Ocean Biochemistry & Ecosystems (OBE).

The mooring is over 6.5 km in length and sits in 4850 m of water giving it a 4 km plus watch circle. The majority of the scientific instruments are housed in the Autonomous Sensor Platform (ASP) suspended 30 m below the surface buoy. Most years the top end of the mooring including the ODAS buoy and the ASP and chain are the only parts replaced. This year for the first time in four years, the

entire mooring has been serviced, which unusually included stripping down and rebuilding the ODAS buoy at sea to replace the keel and many of the meteorological sensors.

PAP 3 is a sediment trap mooring, until 2018 it carried four Maclean sediment traps, three conventional and one inverted, with the inverted one being removed from the design this year. In addition to these there are also two Nortek current meters and one SeaBird Microcat 37IMP. The mooring is 1930 m long, reaching to approximately 2920 m from the surface.

Bathysnap and the amphipod trap are both moored landers provided by OBE. The Ixsea release for the 2017 Bathysnap gave no response during two separate attempts to release it. It is possible that the unit was damaged during deployment but there is no specific evidence for this. The 2018 Bathysnap was deployed without incidence, ranged and triangulated.

### **CTD**

The Stainless steel CTD with 10 litre Niskin bottles was used for sensor calibration of the moored instruments and trialling two of the OTEG nutrient sensors. Salts were taken and run on the Salinometers on board. The CTD system was initially planned to be operated with a swivel of which Sensors and Moorings supplied two, both of which failed before deployment.

### **HyBIS**

The Hydraulic Benthic *In Situ* Sampler (HyBIS) is a modular hybrid platform which can be used with a number of bolt-on modules. It is one of the MARS suite of ROVs and AUVs. For the purposes of the PAP cruise it was used in its most basic configuration as a benthic observation system while the ship followed a predetermined pattern. HyBIS connects up to the ship's fibre optic deep tow cable for deployments over the Starboard gantry. Two MARS technicians deployed HyBIS over a 12-hour watch.

### **Megacorer**

This was supplied by NMF, with technicians from OEG to support it. Deployments were supervised by Brian Bett of OBE and a group of scientists.

### **OTSB (Otter Trawl, Semi Balloon)**

This was deployed via the main block on the stern gantry but supported during deployment and recovery by NMF via the two 5T North Sea deck winches.

### **Ship Fitted Systems**

Ship fitted systems operated with seamless efficiency with extra effort to provide live video feed to shore, helping scientists with OLEX data and sub bottom profiling.

### **Ancillary Equipment**

The Liquid Nitrogen Generator (LNG) was required as part of the cruise agreement and was located in the hanger next to the Wet Lab door, however as no scientists requested liquid nitrogen, it was not switched on during the cruise. Other systems included in the OEG report.

## 6. Mooring operations

The main objectives were to turn round PAP1 and PAP3 moorings. Standard Sensors and Moorings deployment and recovery methods were used for operations involving PAP1 and PAP3 moorings, winches used aboard RRS *James Cook* were the ships Trawl Winch and 2 × 5T deck winches and the new PAP1 Romica Winch supplied by Base Engineering. On the deployment of the CTD containing the IXSEA release units to 4851 m, the deck unit connected to the ship's drop keel was used, this has a transducer cable fitted from the keel to the lab. Of the six releases on the CTD, four gave good ranges and release commands while two did not respond with any ranges, but on recovery of the CTD they were found to have released.

### PAP 1 Mooring

The top end of the PAP1 mooring was to be partially replaced from the keel down. The ODAS buoy was to be retrieved, cleaned and refurbish on the new keel for the 2018 deployment, all of which increased the effort and risk in the operation. Initial observations of the buoy suggested that it sat well in the water and that the lower part that had been painted with antifouling paint looked exceptionally clean compared to previous years and compared to the upper section. This was a good indication that the buoy would be suitable for redeployment.



*2017 PAP 1 mooring buoy recovery*

Stage 1: The ship approached the buoy from the stern and hooked in on the mast lifting point with a 30 T braded rope onto the trawl warp through the gantry. The buoy was then lifted onto the red zone and secured in place so that the structure could be climbed upon to release the hook. The connecting chain was then hauled in using the starboard mounted 5T deck winch with a deck stopper and the frame lifted on board using a strop on the starboard pedestal crane. The bottom end of the sensor frame was disconnected whilst held on the stopper. The sensor frame was then lifted out of the way and the temporary large surface buoy was brought in on the crane and connected to the mooring. The buoy was then released from the starboard crane with a SeaCatch.

Stage 2: The ODAS buoy was separated from its keel and placed on the deck next to the new keel. During the next few days, the ODAS buoy was jet washed and stripped of its 2017 Met Office sensors and communications hub. The new keel was fitted with instruments and the new communications hub was connected through and tested prior to final assembly. The Met Office sensors were also replaced where possible, although damage to connectors at the top end meant that the temperature and humidity sensor could not be replaced, it was also later discovered that the wave sensor had malfunctioned. The new sensor frame was completed and tested through the new buoy on deck before deployment.

Stage 3: Once reassembled in the red zone on the back deck, the buoy was connected to the sensor frame and the mooring rope on the Large Romica winch as per the 2018 schematic. The PAP 1 deployment started by letting some of the chain connecting the buoy to the sensor frame over the stern before releasing the buoy from the trawl warp through the gantry. The frame was then released from the starboard crane and the rope payed out from the Romica through the large sheave on the port crane measuring off Star Oddi positions for the first 700 m.





*PAP 1 sensor frame connected*

The sub-surface float was lifted into position on the starboard crane and the outboard mooring stoppered off while the float was connected into the mooring just before the floating section. The buoy was then released over the stern from a Sea Catch on the starboard crane. The rest of the mooring rope was payed out until the release was fitted, also by holding the outboard mooring on a deck stopper. After which the last 700 m of rope was spooled out, followed by the last 20 m of chain and finally the anchor released from the starboard crane using a SeaCatch.



*PAP 1 subsurface float (anchor weight in foreground)*

Stage 4: With the large Romica winch now empty of rope, the old rope from the previous PAP1 mooring could be retrieved. The ship backed onto the temporary marker buoy and a tag rope was hooked. Unfortunately, the rope parted at the splice, luckily the parted section was grabbed from the stern before it was lost over board and the process continued. The Buoy was lifted on deck using the gantry and disconnected. The IXSEA release did not give any ranges so it was quickly decided to blind fire the release. It soon became apparent that the release had fired due to the subsurface float breaking the surface. The ship then moved away while the rope was reeled in and the Star Oddi sensors removed, there were only a couple of small knots and bights during recovery that did not cause any issues. The subsurface float was brought on deck and the last section of rope retrieved.

Observations and Recommendations: On recovery of PAP1 it was noticed that the forelock shackles on the load cell the pins had started to corrode and the shackle pin looked to be slightly coming away from the main body of the shackle. There was significant deformation on the top eye of the load pin which will need replacing or the pin scrapping. The load cell had failed at some point after deployment, the power and data lead had been ripped out and the connector beaten flat, this will require some rethinking before the in line load cell can be incorporated again. Luckily, as a result of the curtailed pelagic science programme, the number of technical staff on board, and the fine conditions experienced, no real problems were encountered, this should not be assumed for a busier / shorter PAP-SO cruise.



PAP1 ODAS BUOY  
AS DEPLOYED  
JC165 2018

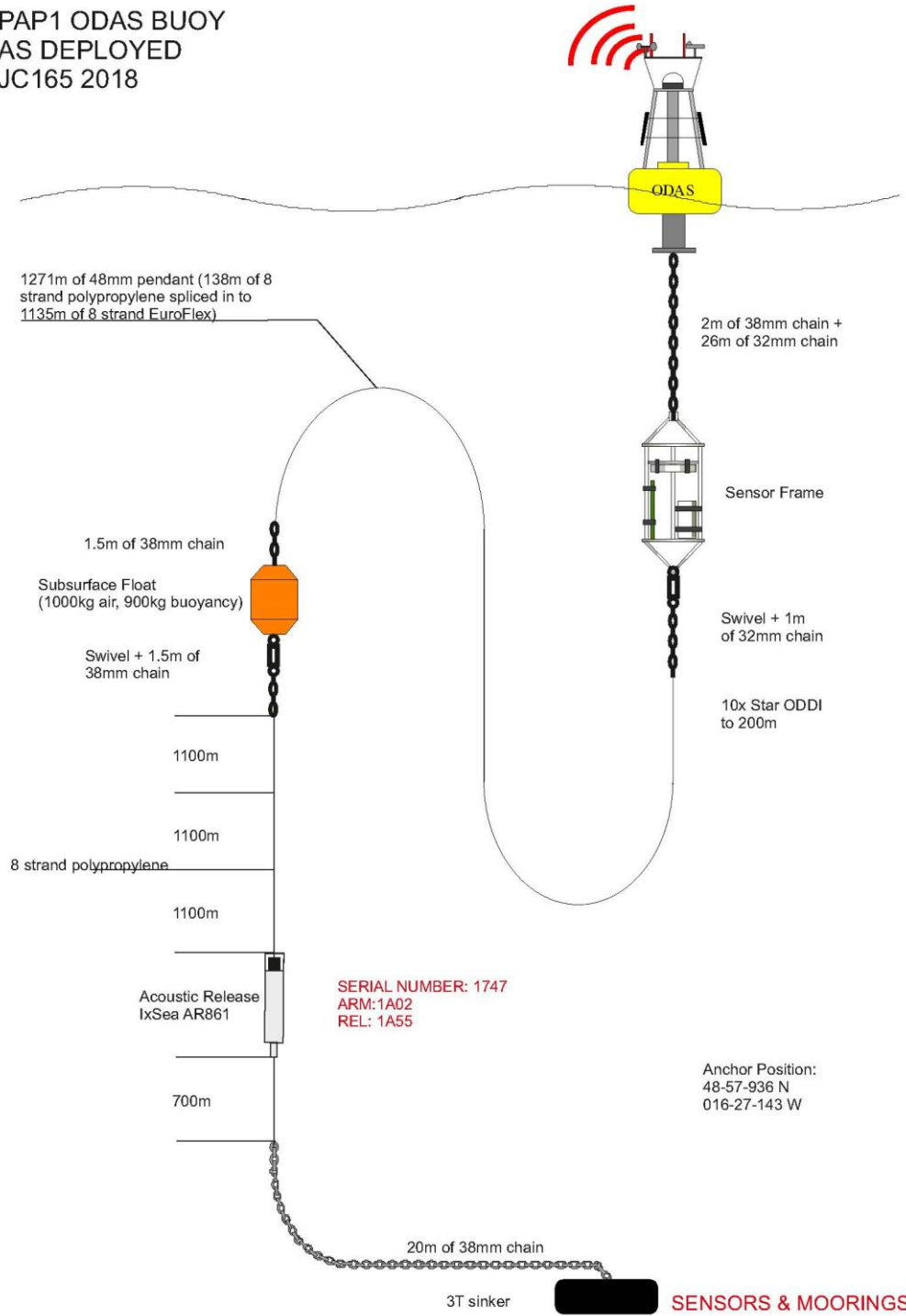

## Buoy Anchor Position Calculator

Mooring Name:	PAP 1 2018																		
Buoy Deployment Method:	Buoy First																		
Planned Seabed Position For Anchor:	<table border="1" style="width: 100%; border-collapse: collapse; text-align: center;"> <thead> <tr> <th colspan="3">LATITUDE</th> <th colspan="3">LONGITUDE</th> </tr> <tr> <th>Degrees</th> <th>Minutes</th> <th>Quad</th> <th>Degrees</th> <th>Minutes</th> <th>Quad</th> </tr> </thead> <tbody> <tr> <td style="background-color: yellow;">48°</td> <td style="background-color: yellow;">57.9950'</td> <td style="background-color: yellow;">N</td> <td style="background-color: yellow;">016°</td> <td style="background-color: yellow;">22.1770'</td> <td style="background-color: yellow;">W</td> </tr> </tbody> </table>	LATITUDE			LONGITUDE			Degrees	Minutes	Quad	Degrees	Minutes	Quad	48°	57.9950'	N	016°	22.1770'	W
LATITUDE			LONGITUDE																
Degrees	Minutes	Quad	Degrees	Minutes	Quad														
48°	57.9950'	N	016°	22.1770'	W														
Water Depth At Planned Seabed Anchor Position:	4,083 m																		
Calculated Fall Back Distance :	583 m																		
Vessels Track:	030.5°																		
Anchor Release Position (At The Stern):	<table border="1" style="width: 100%; border-collapse: collapse; text-align: center;"> <thead> <tr> <th colspan="3">LATITUDE</th> <th colspan="3">LONGITUDE</th> </tr> <tr> <th>Degrees</th> <th>Minutes</th> <th>Quad</th> <th>Degrees</th> <th>Minutes</th> <th>Quad</th> </tr> </thead> <tbody> <tr> <td style="background-color: yellow;">48°</td> <td style="background-color: yellow;">58.3480'</td> <td style="background-color: yellow;">N</td> <td style="background-color: yellow;">016°</td> <td style="background-color: yellow;">21.8130'</td> <td style="background-color: yellow;">W</td> </tr> </tbody> </table>	LATITUDE			LONGITUDE			Degrees	Minutes	Quad	Degrees	Minutes	Quad	48°	58.3480'	N	016°	21.8130'	W
LATITUDE			LONGITUDE																
Degrees	Minutes	Quad	Degrees	Minutes	Quad														
48°	58.3480'	N	016°	21.8130'	W														
Estimated Fall Back Seabed Position:	<table border="1" style="width: 100%; border-collapse: collapse; text-align: center;"> <thead> <tr> <th colspan="3">LATITUDE</th> <th colspan="3">LONGITUDE</th> </tr> <tr> <th>Degrees</th> <th>Minutes</th> <th>Quad</th> <th>Degrees</th> <th>Minutes</th> <th>Quad</th> </tr> </thead> <tbody> <tr> <td style="background-color: yellow;">48°</td> <td style="background-color: yellow;">58.0766'</td> <td style="background-color: yellow;">N</td> <td style="background-color: yellow;">016°</td> <td style="background-color: yellow;">22.0565'</td> <td style="background-color: yellow;">W</td> </tr> </tbody> </table>	LATITUDE			LONGITUDE			Degrees	Minutes	Quad	Degrees	Minutes	Quad	48°	58.0766'	N	016°	22.0565'	W
LATITUDE			LONGITUDE																
Degrees	Minutes	Quad	Degrees	Minutes	Quad														
48°	58.0766'	N	016°	22.0565'	W														

First Buoy Ranging Position:	<table border="1" style="width: 100%; border-collapse: collapse; text-align: center;"> <thead> <tr> <th colspan="3">LATITUDE</th> <th colspan="3">LONGITUDE</th> </tr> <tr> <th>Degrees</th> <th>Minutes</th> <th>Quad</th> <th>Degrees</th> <th>Minutes</th> <th>Quad</th> </tr> </thead> <tbody> <tr> <td style="background-color: yellow;">48°</td> <td style="background-color: yellow;">57.7080'</td> <td style="background-color: yellow;">N</td> <td style="background-color: yellow;">016°</td> <td style="background-color: yellow;">21.5330'</td> <td style="background-color: yellow;">W</td> </tr> </tbody> </table>	LATITUDE			LONGITUDE			Degrees	Minutes	Quad	Degrees	Minutes	Quad	48°	57.7080'	N	016°	21.5330'	W
LATITUDE			LONGITUDE																
Degrees	Minutes	Quad	Degrees	Minutes	Quad														
48°	57.7080'	N	016°	21.5330'	W														
First Ranging Position Ping Distance:	4,171 m																		
Calculated Horizontal Distance:	852 m																		
Second Buoy Ranging Position:	<table border="1" style="width: 100%; border-collapse: collapse; text-align: center;"> <thead> <tr> <th colspan="3">LATITUDE</th> <th colspan="3">LONGITUDE</th> </tr> <tr> <th>Degrees</th> <th>Minutes</th> <th>Quad</th> <th>Degrees</th> <th>Minutes</th> <th>Quad</th> </tr> </thead> <tbody> <tr> <td style="background-color: yellow;">48°</td> <td style="background-color: yellow;">57.7090'</td> <td style="background-color: yellow;">N</td> <td style="background-color: yellow;">016°</td> <td style="background-color: yellow;">22.7850'</td> <td style="background-color: yellow;">W</td> </tr> </tbody> </table>	LATITUDE			LONGITUDE			Degrees	Minutes	Quad	Degrees	Minutes	Quad	48°	57.7090'	N	016°	22.7850'	W
LATITUDE			LONGITUDE																
Degrees	Minutes	Quad	Degrees	Minutes	Quad														
48°	57.7090'	N	016°	22.7850'	W														
Second Ranging Position Ping Distance:	4,178 m																		
Calculated Horizontal Distance:	886 m																		
Third Buoy Ranging Position:	<table border="1" style="width: 100%; border-collapse: collapse; text-align: center;"> <thead> <tr> <th colspan="3">LATITUDE</th> <th colspan="3">LONGITUDE</th> </tr> <tr> <th>Degrees</th> <th>Minutes</th> <th>Quad</th> <th>Degrees</th> <th>Minutes</th> <th>Quad</th> </tr> </thead> <tbody> <tr> <td style="background-color: yellow;">48°</td> <td style="background-color: yellow;">58.4300'</td> <td style="background-color: yellow;">N</td> <td style="background-color: yellow;">016°</td> <td style="background-color: yellow;">22.1630'</td> <td style="background-color: yellow;">W</td> </tr> </tbody> </table>	LATITUDE			LONGITUDE			Degrees	Minutes	Quad	Degrees	Minutes	Quad	48°	58.4300'	N	016°	22.1630'	W
LATITUDE			LONGITUDE																
Degrees	Minutes	Quad	Degrees	Minutes	Quad														
48°	58.4300'	N	016°	22.1630'	W														
Third Ranging Position Ping Distance:	4,105 m																		
Calculated Horizontal Distance:	424 m																		

Arc Sampling Interval:	0.50°	=	6.3 m steps on the arc.																								
Accuracy:	High																										
1st and 2nd Range Arc Intersection Calculated:	Yes																										
2nd and 3rd Range Arc Intersection Calculated:	No																										
3rd and 1st Range Arc Intersection Calculated:	No																										
Calculated Seabed Position	<table border="1" style="width: 100%; border-collapse: collapse; text-align: center;"> <thead> <tr> <th colspan="3">LATITUDE</th> <th colspan="3">LONGITUDE</th> </tr> <tr> <th>Degrees</th> <th>Minutes</th> <th>Quad</th> <th>Degrees</th> <th>Minutes</th> <th>Quad</th> </tr> </thead> <tbody> <tr> <td style="background-color: yellow;">00°</td> <td style="background-color: yellow;">00.0000'</td> <td style="background-color: yellow;">Quad</td> <td style="background-color: yellow;">000°</td> <td style="background-color: yellow;">00.0000'</td> <td style="background-color: yellow;">Quad</td> </tr> <tr> <td style="background-color: yellow;">48°</td> <td style="background-color: yellow;">57.9360'</td> <td style="background-color: yellow;">N</td> <td style="background-color: yellow;">016°</td> <td style="background-color: yellow;">22.1430'</td> <td style="background-color: yellow;">W</td> </tr> </tbody> </table>	LATITUDE			LONGITUDE			Degrees	Minutes	Quad	Degrees	Minutes	Quad	00°	00.0000'	Quad	000°	00.0000'	Quad	48°	57.9360'	N	016°	22.1430'	W		
LATITUDE			LONGITUDE																								
Degrees	Minutes	Quad	Degrees	Minutes	Quad																						
00°	00.0000'	Quad	000°	00.0000'	Quad																						
48°	57.9360'	N	016°	22.1430'	W																						

WARNING!: One Or More Of The Ping Ranging Distances Is In Error. The Seabed Position Of The Mooring Has Therefore Been Calculated With Limited Accuracy

### **PAP 3 Mooring**

On deployment and recovery of PAP3 the port side 5T deck winch was used with no problems, after concerns about its load bearing capability.

Stage 1: The PAP 3 mooring was released and the Billings float hooked on the starboard quarter. Standard mooring procedure was used to bring the PAP3 mooring on deck. On the recovery operation for PAP3 the Billings float and first section of glass buoyancy along with the 15 m polyprop and 50 m of polyester braid above and below the buoyancy were recovered to the deck in a tangled mess, the mast on the Billing float snapped as it was being hauled onto the deck and the Novatech beacon was lost to the deep and the Billings floated off into the distance while we continued to recover the mooring. There were no other problems for most of the recovery of the very last sediment trap. The last of the 500 m lengths of polyester braid making up the 1500 m section had become tangled around the glass buoyancy above the sediment trap. On recovering the buoyancy to deck, the sediment trap was just below the surface, the rope parted with the trap dropping away. The ropes were stopped off and the loose bights brought in when it was noticed that the rope leading to the bottom of the sediment trap was chaffed in two sections. The rope was stopped off and dangerous sections cut out and re-joined to bring the sediment trap onto the aft deck, it did come in upside down but trap and instruments under the trap were all recovered intact.

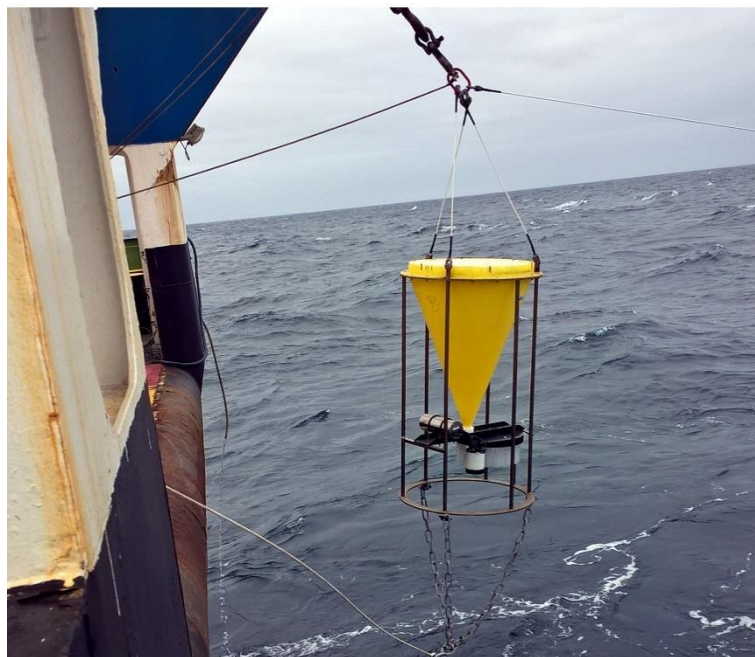

*Sediment trap deployment*

Stage 2: There was no double-barrelled winch on the deck for this cruise, so PAP3 mooring deployment and recovery was done using the port side 5T deck winch and aft port pedestal crane, this type of

deployment is known as a “live deployment.” The starboard pedestal crane was used for the deployment of all three sediment traps.

Observations and Recommendations: To look at Billings float mast, maybe go back to plastic mast that would be more robust than fibre glass when recovering to the aft deck when tangled with buoyancy and rope.

### PAP 3 TO DEPLOY JC 165 2018

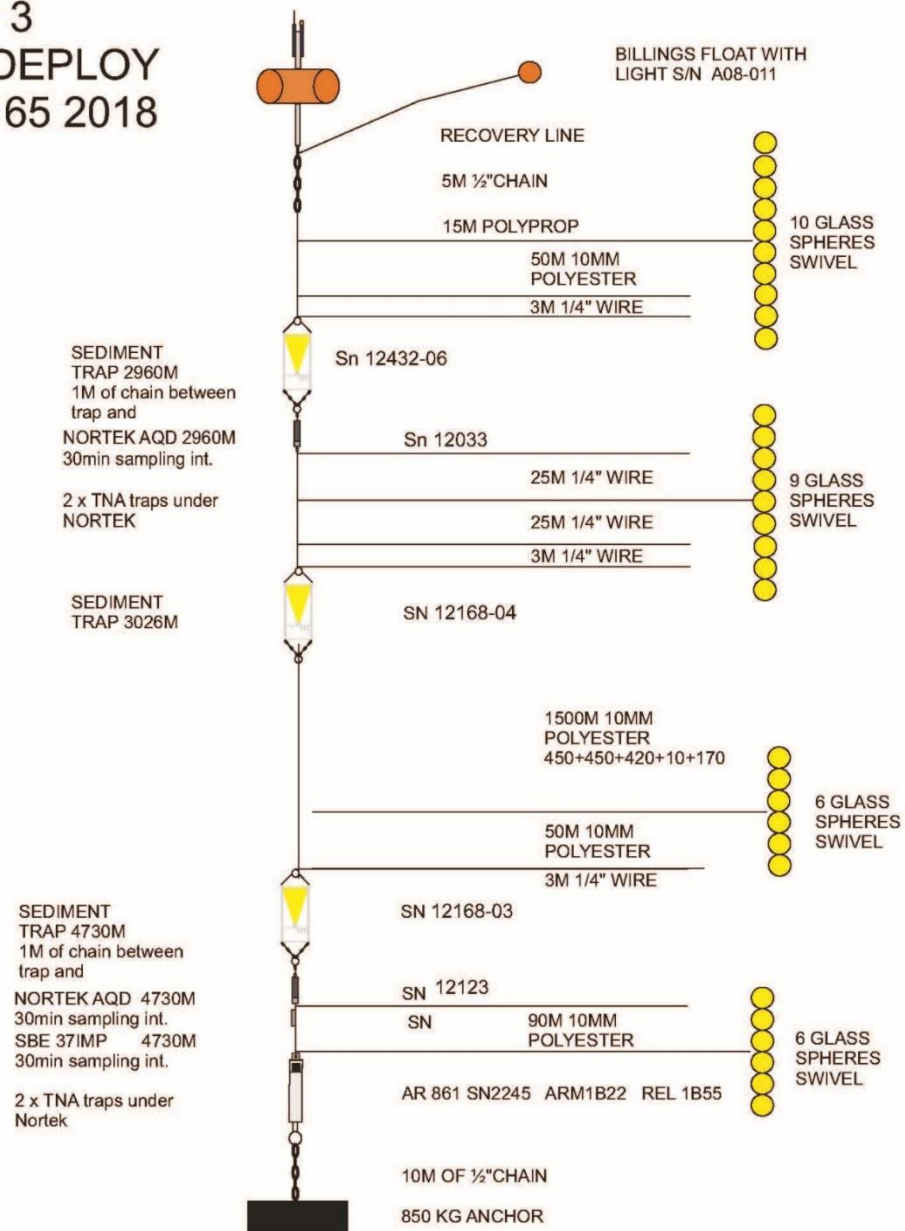



## Buoy Anchor Position Calculator

Mooring Name:	PAP 3 2018					
Buoy Deployment Method:	Buoy First					
Planned Seabed Position For Anchor:	LATITUDE			LONGITUDE		
	Degrees	Minutes	Quad	Degrees	Minutes	Quad
	49°	00.1520'	N	016°	27.3690'	W
Water Depth At Planned Seabed Anchor Position:	4,810 m					
Calculated Fall Back Distance :	687 m					
Vessels Track:	110.0°					
Anchor Release Position (At The Stern):	LATITUDE			LONGITUDE		
	Degrees	Minutes	Quad	Degrees	Minutes	Quad
	49°	00.1520'	N	016°	27.3690'	W
Estimated Fall Back Seabed Position:	LATITUDE			LONGITUDE		
	Degrees	Minutes	Quad	Degrees	Minutes	Quad
	49°	00.2789'	N	016°	27.9005'	W

First Buoy Ranging Position:	LATITUDE			LONGITUDE		
	Degrees	Minutes	Quad	Degrees	Minutes	Quad
	49°	00.6000'	N	016°	27.5000'	W
First Ranging Position Ping Distance:	4,837 m					
Calculated Horizontal Distance:	510 m					
Second Buoy Ranging Position:	LATITUDE			LONGITUDE		
	Degrees	Minutes	Quad	Degrees	Minutes	Quad
	48°	59.8000'	N	016°	26.8000'	W
Second Ranging Position Ping Distance:	5,032 m					
Calculated Horizontal Distance:	1,478 m					
Third Buoy Ranging Position:	LATITUDE			LONGITUDE		
	Degrees	Minutes	Quad	Degrees	Minutes	Quad
	48°	59.8000'	N	016°	27.9000'	W
Third Ranging Position Ping Distance:	4,880 m					
Calculated Horizontal Distance:	824 m					

Arc Sampling Interval:	0.50°	=	8.2 m steps on the arc.			
Accuracy:	High					
1st and 2nd Range Arc Intersection Calculated:	No					
2nd and 3rd Range Arc Intersection Calculated:	Yes					
3rd and 1st Range Arc Intersection Calculated:	No					
Calculated Seabed Position	LATITUDE			LONGITUDE		
	Degrees	Minutes	Quad	Degrees	Minutes	Quad
	49°	00.2400'	N	016°	27.8160'	W

**WARNING!** One Or More Of The Ping Ranging Distances Is In Error. The Seabed Position Of The Mooring Has Therefore Been Calculated With Limited Accuracy

Version 2.7  
Tim Page 13th August 2016

### **Bathysnap and amphipod trap**

The 2017 Bathysnap failed to respond to either the hull mounted transducer or the Superducer when ranged from the deck unit, two attempts were made to blind fire the release, but the package never returned. It is possible the system is still intact and working, one suggestion was to go back and try the release with all thrusters switched off, which has worked on occasions. The deployment of the 2018 Bathysnap and amphipod traps went without incident.

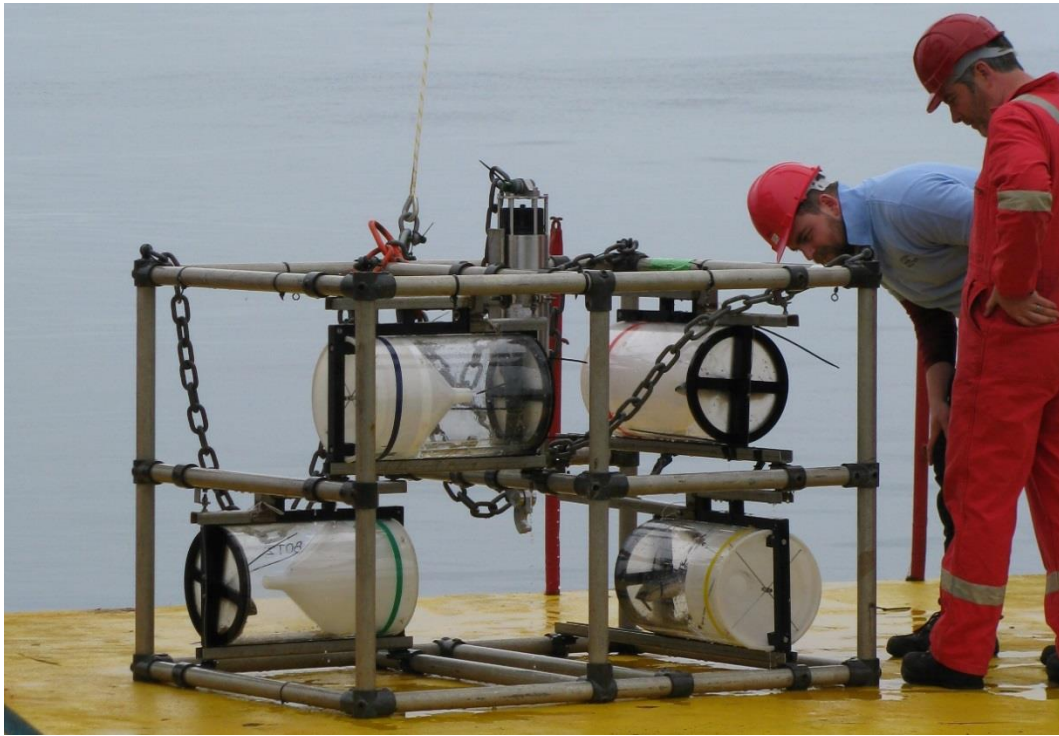

*Recovered OBE amphipod trap system*

## Buoy Anchor Position Calculator

Mooring Name:	Bathysnap 2018					
Buoy Deployment Method:	Buoy First					
Planned Seabed Position For Anchor:	LATITUDE			LONGITUDE		
	Degrees	Minutes	Quad	Degrees	Minutes	Quad
	49°	00.3000'	N	016°	27.9000'	W
Water Depth At Planned Seabed Anchor Position:	4,802 m					
Calculated Fall Back Distance :	686 m					
Vessels Track:	082.2°					
Anchor Release Position (At The Stern):	LATITUDE			LONGITUDE		
	Degrees	Minutes	Quad	Degrees	Minutes	Quad
	49°	00.3040'	N	016°	27.9040'	W
Estimated Fall Back Seabed Position:	LATITUDE			LONGITUDE		
	Degrees	Minutes	Quad	Degrees	Minutes	Quad
	49°	00.2537'	N	016°	28.4634'	W

First Buoy Ranging Position:	LATITUDE			LONGITUDE		
	Degrees	Minutes	Quad	Degrees	Minutes	Quad
	49°	00.0660'	N	016°	27.2770'	W
First Ranging Position Ping Distance:	4,883 m					
Calculated Horizontal Distance:	886 m					
Second Buoy Ranging Position:	LATITUDE			LONGITUDE		
	Degrees	Minutes	Quad	Degrees	Minutes	Quad
	49°	00.0628'	N	016°	28.5605'	W
Second Ranging Position Ping Distance:	4,861 m					
Calculated Horizontal Distance:	755 m					
Third Buoy Ranging Position:	LATITUDE			LONGITUDE		
	Degrees	Minutes	Quad	Degrees	Minutes	Quad
	49°	00.8000'	N	016°	27.9860'	W
Third Ranging Position Ping Distance:	4,892 m					
Calculated Horizontal Distance:	934 m					

Arc Sampling Interval:	0.50°	=	7.5 m steps on the arc.			
Accuracy:	High					
1st and 2nd Range Arc Intersection Calculated:	No					
2nd and 3rd Range Arc Intersection Calculated:	Yes					
3rd and 1st Range Arc Intersection Calculated:	Yes					
Calculated Seabed Position	LATITUDE			LONGITUDE		
	Degrees	Minutes	Quad	Degrees	Minutes	Quad
	49°	00.3000'	N	016°	27.9840'	W

**WARNING!. One Or More Of The Ping Ranging Distances Is In Error. The Seabed Position Of The Mooring Has Therefore Been Calculated With Limited Accuracy**

Version 2.7  
Tim Page 13th August 2016

## 7. CTD systems

### CTD Operations

A total of 13 CTD casts were undertaken on the cruise making use of an NMF 24-way Stainless Steel CTD frame with 10 L Niskin water samplers. Between casts the sensors were flushed with MilliQ three times before installation of caps on the TC-duct inlet and pump exhaust of both sensor pairs. After the rosette had been sampled, the whole CTD package was rinsed with fresh water to prevent salt crystals forming in the sensors, associated tubing and particularly the carousel latch assembly.

### Instrument Configuration

The following sensors were installed on the Stainless Steel CTD frame and used throughout the cruise:

<b>Instrument / Sensor</b>	<b>Model</b>	<b>Serial No</b>	<b>Channel</b>	<b>Casts Used</b>
Stainless steel 24-way frame	NOCS	SBE CTD9	N/A	All casts
24-way Carousel	SBE 32	32-19817-0243	N/A	All casts
Primary CTD deck unit	SBE 11plus	11p-19817-0495	N/A	All casts
CTD Underwater Unit	SBE 9plus	09p-87077-1257	N/A	All casts
Primary Temperature Sensor	SBE 3P	03p-4383	F1	All casts
Primary Conductivity Sensor	SBE 4C	04c-2571	F2	All casts
Digiquartz Pressure sensor	Paroscientific	134949	F3	All casts
Secondary Temperature Sensor	SBE 3P	03p-5494	F4	All casts
Secondary Conductivity Sensor	SBE 4C	04c-2580	F5	All casts
Primary Pump	SBE 5T	05t-3088	N/A	All casts
Secondary Pump	SBE 5T	05t-4539	N/A	All casts
Primary Dissolved Oxygen Sensor	SBE 43	43-0619	V0	All casts
Light Scattering Sensor	WETLabs BBRTD	BBRTD-182	V2	All casts
Altimeter	Benthos 916T	41302	V3	All casts
Transmissometer	WET Labs C-Star	CST-1654DR	V6	All casts
Fluorometer	CTG Aquatracka MKIII	088244	V7	All casts
10L Water Samplers	OTE	1A-24A	N/A	All casts



The following Seasave Instrument Configuration file was used throughout the cruise:

```

<?xml version="1.0" encoding="UTF-8"?>
<SBE_InstrumentConfiguration
SB_ConfigCTD_FileVersion="7.26.2.0" >
  <Instrument Type="8" >
    <Name>SBE 911plus/917plus CTD</Name>

<FrequencyChannelsSuppressed>0</FrequencyChannelsSuppre
ssed>
  <VoltageWordsSuppressed>0</VoltageWordsSuppressed>
  <ComputerInterface>0</ComputerInterface>
  <!-- 0 == SBE11plus Firmware Version >= 5.0 -->
  <!-- 1 == SBE11plus Firmware Version < 5.0 -->
  <!-- 2 == SBE 17plus SEARAM -->
  <!-- 3 == None -->
  <DeckUnitVersion>0</DeckUnitVersion>
  <ScansToAverage>1</ScansToAverage>
  <SurfaceParVoltageAdded>0</SurfaceParVoltageAdded>
  <ScanTimeAdded>1</ScanTimeAdded>
  <NmeaPositionDataAdded>1</NmeaPositionDataAdded>
  <NmeaDepthDataAdded>0</NmeaDepthDataAdded>
  <NmeaTimeAdded>0</NmeaTimeAdded>

<NmeaDeviceConnectedToPC>1</NmeaDeviceConnectedToP
C>
  <SensorArray Size="13" >
    <Sensor index="0" SensorID="55" >
      <TemperatureSensor SensorID="55" >
        <SerialNumber>03P-4383</SerialNumber>
        <CalibrationDate>19 July 2017</CalibrationDate>
        <UseG_J>1</UseG_J>
        <A>0.0000000e+000</A>
        <B>0.0000000e+000</B>
        <C>0.0000000e+000</C>
        <D>0.0000000e+000</D>
        <F0_Old>0.000</F0_Old>
        <G>4.39853378e-003</G>
        <H>6.55124310e-004</H>
        <I>2.40295187e-005</I>
        <J>1.96531926e-006</J>
        <F0>1000.000</F0>
        <Slope>1.0000000</Slope>
        <Offset>0.0000</Offset>
      </TemperatureSensor>
    </Sensor>
    <Sensor index="1" SensorID="3" >
      <ConductivitySensor SensorID="3" >
        <SerialNumber>04C-2571</SerialNumber>
        <CalibrationDate>20 July 2017</CalibrationDate>
        <UseG_J>1</UseG_J>
        <!-- Cell const and series R are applicable only for wide
range sensors. -->
        <SeriesR>0.0000</SeriesR>
        <CellConst>2000.0000</CellConst>
        <ConductivityType>0</ConductivityType>
        <Coefficients equation="0" >
          <A>0.0000000e+000</A>
          <B>0.0000000e+000</B>
          <C>0.0000000e+000</C>
          <D>0.0000000e+000</D>
          <M>0.0</M>
          <CPcor>-9.5700000e-008</CPcor>
        </Coefficients>
        <Coefficients equation="1" >
          <G>-9.9325171e+000</G>
          <H>1.54037944e+000</H>
          <I>3.42845023e-004</I>
          <J>8.68686417e-005</J>
          <CPcor>-9.5700000e-008</CPcor>
          <CTcor>3.2500e-006</CTcor>
          <!-- WBOTC not applicable unless ConductivityType =
1. -->
          <WBOTC>0.0000000e+000</WBOTC>
        </Coefficients>
        <Slope>1.0000000</Slope>
        <Offset>0.00000</Offset>
      </ConductivitySensor>
    </Sensor>
    <Sensor index="2" SensorID="45" >
      <PressureSensor SensorID="45" >
        <SerialNumber>134949</SerialNumber>
        <CalibrationDate>9 November 2015</CalibrationDate>
        <C1>-3.695717e+004</C1>
        <C2>-2.691791e-001</C2>
        <C3>1.143300e-002</C3>
        <D1>3.349300e-002</D1>
        <D2>0.000000e+000</D2>
        <T1>3.049225e+001</T1>
        <T2>-3.372510e-004</T2>
        <T3>3.990980e-006</T3>
        <T4>3.875890e-009</T4>
        <Slope>1.0000000</Slope>
        <Offset>0.00000</Offset>
        <T5>0.000000e+000</T5>
        <AD590M>1.280300e-002</AD590M>
        <AD590B>-9.092836e+000</AD590B>
      </PressureSensor>
    </Sensor>
    <Sensor index="3" SensorID="55" >
      <TemperatureSensor SensorID="55" >
        <SerialNumber>03P-5494</SerialNumber>
        <CalibrationDate>27 September 2017</CalibrationDate>
        <UseG_J>1</UseG_J>
        <A>0.0000000e+000</A>
        <B>0.0000000e+000</B>
        <C>0.0000000e+000</C>
        <D>0.0000000e+000</D>
        <F0_Old>0.000</F0_Old>
        <G>4.32413647e-003</G>
        <H>6.25842090e-004</H>
        <I>1.93295066e-005</I>
        <J>1.45373148e-006</J>
        <F0>1000.000</F0>
        <Slope>1.0000000</Slope>
        <Offset>0.0000</Offset>
      </TemperatureSensor>
    </Sensor>
    <Sensor index="4" SensorID="3" >
      <ConductivitySensor SensorID="3" >
        <SerialNumber>04C-2580</SerialNumber>
        <CalibrationDate>27 July 2017</CalibrationDate>
        <UseG_J>1</UseG_J>
        <!-- Cell const and series R are applicable only for wide
range sensors. -->
        <SeriesR>0.0000</SeriesR>
        <CellConst>2000.0000</CellConst>
        <ConductivityType>0</ConductivityType>
        <Coefficients equation="0" >
          <A>0.0000000e+000</A>
          <B>0.0000000e+000</B>
          <C>0.0000000e+000</C>
          <D>0.0000000e+000</D>
          <M>0.0</M>
          <CPcor>-9.5700000e-008</CPcor>
        </Coefficients>
        <Coefficients equation="1" >
          <G>-1.04717345e+001</G>
          <H>1.53894573e+000</H>
          <I>5.99368719e-004</I>
          <J>4.18086687e-005</J>

```

```

    <CPcor>9.57000000e-008</CPcor>
    <CTcor>3.2500e-006</CTcor>
    <!-- WBOTC not applicable unless ConductivityType =
1. -->
    <WBOTC>0.00000000e+000</WBOTC>
    </Coefficients>
    <Slope>1.00000000</Slope>
    <Offset>0.00000</Offset>
    </ConductivitySensor>
</Sensor>
<Sensor index="5" SensorID="38" >
<OxygenSensor SensorID="38" >
    <SerialNumber>43-0619</SerialNumber>
    <CalibrationDate>14 October 2017</CalibrationDate>
    <Use2007Equation>1</Use2007Equation>
    <CalibrationCoefficients equation="0" >
    <!-- Coefficients for Owens-Millard equation. -->
    <Boc>0.0000</Boc>
    <Soc>0.0000e+000</Soc>
    <offset>0.0000</offset>
    <Pcor>0.00e+000</Pcor>
    <Tcor>0.0000</Tcor>
    <Tau>0.0</Tau>
    </CalibrationCoefficients>
    <CalibrationCoefficients equation="1" >
    <!-- Coefficients for Sea-Bird equation - SBE calibration
in 2007 and later. -->
    <Soc>5.9230e-001</Soc>
    <offset>-0.5062</offset>
    <A>-3.7031e-003</A>
    <B> 1.3544e-004</B>
    <C>-1.9849e-006</C>
    <D0> 2.5826e+000</D0>
    <D1> 1.92634e-004</D1>
    <D2>-4.64803e-002</D2>
    <E> 3.6000e-002</E>
    <Tau20> 1.0900</Tau20>
    <H1>-3.3000e-002</H1>
    <H2> 5.0000e+003</H2>
    <H3> 1.4500e+003</H3>
    </CalibrationCoefficients>
    </OxygenSensor>
</Sensor>
<Sensor index="6" SensorID="27" >
    <NotInUse SensorID="27" >
    <SerialNumber></SerialNumber>
    <CalibrationDate></CalibrationDate>
    <OutputType>2</OutputType>
    <Free>1</Free>
    </NotInUse>
</Sensor>
<Sensor index="7" SensorID="70" >
    <TurbidityMeter SensorID="70" >
    <SerialNumber>BBRTD-182</SerialNumber>
    <CalibrationDate>6 March 2017</CalibrationDate>
    <ScaleFactor>3.343e-003</ScaleFactor>
    <!-- Dark output -->
    <DarkVoltage>6.600e-002</DarkVoltage>
    </TurbidityMeter>
</Sensor>
<Sensor index="8" SensorID="0" >
    <AltimeterSensor SensorID="0" >
    <SerialNumber>41302</SerialNumber>
    <CalibrationDate>13 March 2006</CalibrationDate>
    <ScaleFactor>15.000</ScaleFactor>
    <Offset>0.000</Offset>
    </AltimeterSensor>
</Sensor>
<Sensor index="9" SensorID="27" >
    <NotInUse SensorID="27" >
    <SerialNumber></SerialNumber>
    <CalibrationDate></CalibrationDate>
    <OutputType>2</OutputType>
    <Free>1</Free>
    </NotInUse>
</Sensor>
<Sensor index="10" SensorID="27" >
    <NotInUse SensorID="27" >
    <SerialNumber></SerialNumber>
    <CalibrationDate></CalibrationDate>
    <OutputType>2</OutputType>
    <Free>1</Free>
    </NotInUse>
</Sensor>
<Sensor index="11" SensorID="71" >
    <WET_LabsCStar SensorID="71" >
    <SerialNumber>CST-1654DR</SerialNumber>
    <CalibrationDate>16 April 2017</CalibrationDate>
    <M>21.2217</M>
    <B>-0.1295</B>
    <PathLength>0.250</PathLength>
    </WET_LabsCStar>
</Sensor>
<Sensor index="12" SensorID="5" >
    <FluoroChelseaAqua3Sensor SensorID="5" >
    <SerialNumber>088244</SerialNumber>
    <CalibrationDate>29 September 2016</CalibrationDate>
    <VB>0.185700</VB>
    <V1>2.079400</V1>
    <Vacetone>0.342300</Vacetone>
    <ScaleFactor>1.000000</ScaleFactor>
    <Slope>1.000000</Slope>
    <Offset>0.000000</Offset>
    </FluoroChelseaAqua3Sensor>
</Sensor>
</SensorArray>
</Instrument>
</SBE_InstrumentConfiguration>

```

## CTD suite technical issues and instrument changes

On cast 001, immediately after the package had entered the water, the CTD deck unit alarmed, the cast was stopped and the package brought back to the deck for investigation. As we were still able to receive data from the CTD, an electrical termination fault was ruled out. At this point it was suspected that the bottom contact connector may be causing the problem, and on closer inspection it was found that the blanking plug on JB6 was not fully seated. After a quick clean, and a squirt of silicone lubricant, the connector was refitted, the CTD cast restarted and the fault cleared. All subsequent casts were completed without any further problems.

There were some issues with various Niskin water samplers not closing on firing, to help minimise this, the rosette was washed with fresh water between casts. Some of the 10 L Niskin's required replacement O-rings and tap spares and one bottle screw cap. Any defects found with the Niskin's were reported to the NMF technicians by the scientific party allowing for replacements to be fitted. One topside termination was made during the steam to the worksite and no further terminations were required.

*Cast Summary*

Cast Number	Julian Day	Max. Wire Out
CTD001	142	10
CTD002	142	100
CTD003	142	100
CTD004	143	4820
CTD005	145	100
CTD006	145	4828
CTD007	147	100
CTD008	147	2000
CTD009	149	4830
CTD010	152	100
CTD011	152	4828
CTD012	158	500
CTD013	158	4827
Total Veer	27143 m	
Total Haul	27143 m	
Total Wire Distance	54286 m	

*Data Processing:* Standard Sea-Bird processing of the raw data was completed using Sea-Bird Data Processing software. The processing order used for all casts was as follows:

- Data Conversion
- Bottle Summary
- Align CTD
- Cell TM

At the start of the cruise, each step was set up in cooperation with the scientific party using BODC's preferred settings where possible. After each cast, the raw data was immediately backed up to the network drive to avoid any data loss. Once backed up, processing of the cast data took place and this was also immediately backed up to the network drive to avoid data loss.

*Salinity Processing:* Salinity samples were taken from the CTD rosettes by the scientific party using crates of sample bottles (24 bottles per crate). These were, once filled, moved to the Electronics Workshop and left for a period of at least 24 hours prior to processing to allow the samples to equilibrate

to the lab temperature. Samples were analysed on a Guildline Autosol 8400B SN: 72227 by NMF Technicians throughout the cruise, this also included the processing of all the underway samples. At the start of the cruise the salinometer was standardised using IAPSO Standard Seawater batch P161 (K15=0.99987, 2xK15=1.99974, 34.995 PSU). An IAPSO Standard Seawater standard was run as a sample before and after each crate of samples as a control. A data file from the analysis software was supplied for each crate as an Excel spreadsheet. All measurements were also logged manually on paper log-sheets. These log-sheets were also supplied along with scans in pdf format. Software Used:

- Aquadopp Deep Water 1.40.14
- Autosol\_2009 V1
- Pcomm Terminal Emulator 2.10
- Sea-Bird SeaTerm 1.59
- Sea-Bird Seasave 7.26.6.26
- Sea-Bird SBE Data Processing 7.26.6.28
- Microsoft Office

## 8. HyBIS System

Cruise Outline. HyBIS was used during JC165 to make video transects over the PAP site and to record HD stills images. Basic stats:

No. of dives JC165 (Dives HY18 - HY27):	10
Water depths:	3950 - 4850m
Total time at seabed:	45:54 hrs
Total run time:	79:38 hrs
Total Video (Apple ProRes 422):	HD 2.38 TB; PAL 95.6 GB
Scorpio images:	28967 images; 95.1 GB

Master #1 Lacie Raid unit SER# (MRVL002B6E8141A6B53) will be installed in the NOC media room for BODC to archive and provide access for scientists post cruise.

Backup #1 Lacie Raid unit SER# (MRVL002B6E1935F8C05) will be retained by the ROV team until BODC have archived the Master unit

Mobilisation. Southampton (NOC), 15-18 May 2018. The HyBIS system was mobilised in Southampton. During the week, the rack mounted electronics and computers were set up in the main lab and the ships data feeds required for the HyBIS software were provided by the Ship Systems Technician. Since the ship's WMT beacon was going to be used, the ships Sonardyne software was also configured to send an UDP stream to the HyBIS computers. They also supplied a Winch CCTV Video Feed along with a ship's supplied Display Monitor/TV since this is required for the Winch Operator.

OEG made the Evergrip termination to the Deep Tow cable and approximately 4 m of wire were exposed to allow for the electrical and fibre optic terminations. According to the new NMF Standard Operating Procedure put in place "Assurance of availability of ship's fitted scientific electro-optical system", HyBIS technicians should have received a termination certificate to guarantee the cable had been electrically tested and Fibre Optic power meter readings had been done. This was not the case for this cruise. Since these checks had not been carried out, ROV Team members had to carry out the checks to ensure the cable was ready to be used.

On Wednesday, the electrical tests were done on the Deep Tow cable. The Deep Tow cable mechanical termination was then load tested with 4000 kg for 5 minutes. On Thursday, the fibre optic termination was done. Using an OTDR and power meters, readings were taken to check the strength and integrity of the fibre optic signal. On Friday, after CTD mobilisation was completed, HyBIS was powered up on high voltage (HV). During the first HV power up, Scorpio video signal was received but no PAL camera feeds or telemetry data, therefore no control over lights or thrusters. Power measurements were redone to check the status of the fibre and the measurements showed -10 dBm on the Telemetry fibre tail into the rack, while -8 dBm on the Scorpio. Therefore, signals were well within specs. The next step was to

check if the Focal top unit was receiving power, so the Focal tray on the rack was opened and checked it function correctly.

It was discussed that back at base, HyBIS was usually powered from the 240 V wall socket. The last day before mobilisation, a full system check was also done with the HV, so in theory, nothing should have changed between then and mobilisation. To keep diagnosing, HyBIS was powered up on the deck lead, supplying single phase 240 V AC directly to the telemetry tube instead of using the HV cable that feeds the HV transformer. This time, HyBIS powered up correctly and all sensors sent their data, as well as being able to turn on/off lights with the topside control box. HyBIS was then powered up on HV once more and the system worked correctly. The conclusion was that since HyBIS had not been powered up recently, it probably needed a “top up”/couple of power cycles for the boards and capacitors to charge up. This often occurs with the Scorpio, but this time it has happened with the vehicle. A similar first time power up issue occurred on the previous science cruise JC138. The isolation procedure was carried out and vehicle made safe for stowing.

It should be noted that for the next HyBIS mobilization the Deep Tow Cable Pre-Cruise Termination and Certification must be planned correctly so that it does not delay mobilisation and set up of HyBIS on DY094. Fibres power meter readings by ROV team on 17/05 were:

	1310 nm	1550 nm
Red	-7.2 dB	-8.4 dB
Grey	-8.0 dB	-9.6 dB
Black	-8.2 dB	-11.7 dB

Therefore, the Red fibre will be used for the Telemetry to the vehicle and the Grey fibre for the Scorpio camera.

De-Mobilisation. The HyBIS system remained on board the RSS *James Cook* for JC166-JC167 ROV Trials so there was no de-mobilisation post JC165.

Umbilical Termination. During JC165, HyBIS and Coring operations took place one after the other so HyBIS had to be isolated and the deep tow cable removed from the oil-filled HV junction box (JB) after each dive. This process is really delicate since the 900 µm fibre optic tails that are spliced to the umbilical have to be disconnected, along with the three electrical cores before being taken out of the HV JB and slid into the protective tube for transport. The deep tow cable is then brought up through the sheaves and placed out of the way on the hangar top. This is necessary because the deep tow and coring cable share the same sheaves. This whole process is done in a controlled manner and as gently as possible, but the fibre optics can be easily damage during the extraction and transportation. The risk is that bending or tangling of the fibres can occur and this increases the likelihood of an internal fibre break.

On the first two dives there were no issues from the fibres. On the third, HY20, the dive was aborted at 20 m after no communications were established with the vehicle. Upon recovery, power meter measurements were made along with an OTDR, which proved the red and the black fibre were broken on the HyBIS termination end of deep tow cable. A quick repair of the red fibre was made on deck by fusing on a new ST tail. This allowed the dive to be resumed without too much delay. To reduce subsequent unwanted delays due to fibre optic damage, power meter readings were then taken each time the deep tow cable was reinstated into HyBIS to check whether damage had occurred during swapping of the ship's cables. This eliminated the risk of discovering a problem once HyBIS had been deployed.

During HY23 pre-dive checks it was found that there was vehicle telemetry communication but no Scorpio video signal. Checking the fibre rattler converter on the rack, none of the signal strength LED's were lit up. Doing a power meter reading, only -20 dBm were being received on the ST tail connected to the rack. Cleaning all the connectors in the lab allowed the Scorpio video to function, but it flickered and disconnected constantly, proving that we were barely receiving the minimum receiver sensitivity levels. Therefore, a full deep tow cable termination had to be done since the fibre had been damaged again. Once finished the termination, power readings from F.O termination from workshop to F.O JB of Main lab. (Transmitter sends -7 dBm) were:

	1310 nm	1550 nm
Red	-14.0 dBm (7dB)	-16 dBm(9dB)
Grey	-16.3 dBm (9.5dB)	-18 dBm(11dB)
Black	-15.3 dBm (8.6dB)	-20 dBm(13dB)

The deep tow cable was then connected again to Hybis and the dive finished successfully. The photo below shows how the fibre terminations can tangle and damage while inside the protective tube.



Suggestions/Recommendations. Check stock of Evergrip terminations, fibre optic components, electrical cable crimps and re-stock as required.

High Voltage Operations. Prior to the cruise the HV operations were discussed and agreed with the RRS *James Cook* Master. It was agreed that the HyBIS HV responsible person would take responsibility of the HV cage keys throughout the cruise. HyBIS would not be operated using HV on deck and would be powered up and powered down and earthed at 20 m water depth. The bridge was notified via VHF

radio each time HyBIS was turned on and powered down. A permit to work / isolation certificate was filled out at the end of each dive to show that the vehicle was isolated and HV probes were used each time the HV JB was opened.

Suggestions/Recommendations. NMF will review current HyBIS permit to work / isolation Certificate. HyBIS is different from ISIS in that the power is completely disconnected and locked out of the ship system and an earthing spider is attached after each dive. There should never be a situation where a permit to work on HyBIS is required while it is still connected to the ship. It is suggested that for HyBIS the joint permit to work / isolation certificate is replaced by just an isolation certificate.

HyBIS System. During this cruise the HyBIS vehicle was stowed on deck outside of the starboard workshop and moved by crane into position under the parallelogram prior to each dive. Only the downward looking camera module was mobilised and the associated HyBIS spares boxes and consumables were stowed in cages in the main hangar. The power supply (240 V 5 kW) was housed in the HV cage and topside displays and interfaces setup in the middle bay of the main laboratory. Deck testing was achieved using the 240 V AC deck lead plugged into a socket in the starboard workshop. A deck fibre optic lead was temporarily connected to the F.O. JB in the hangar because it was a shorter run and provided less of a trip hazard than routing it along the deck, past the CTD and through the doors to the main lab.

Hydraulic System. During JC165 the HyBIS hydraulics were not required, however, it was noted that the problem of the hydraulic reservoir emptying, which was noted during JC138 still persisted. During the first HyBIS dive of JC165 (HY18) it was noted that the hydraulic reservoir had emptied even though the hydraulics had not been used. During dive HY22 a DSPL light and one of the PAL cameras was pointed at the pressure relief valve on the Schilling comp. to see if it was the source of the leak. The PAL feed was recorded and it could be seen that although the relief valve was not leaking, oil was entering the water and by the time HyBIS had reached the seabed at c. 4850 m water depth, the comp. had completely emptied.

For dive HY24 the light and PAL camera were positioned to look at the starboard valve pack and hydraulic motor. During this dive the leak was pinpointed to the band clamp that holds each side of the hydraulic reservoir Schilling compensator together. To try and fix the leak, the band clamp was tightened and the comp. was again observed during dive HY25. The comp. did not begin to leak until approximately 3500 m water depth and the flow of oil had slowed but the comp did still slowly empty. The comp requires servicing/replacing.

Suggestions/Recommendations. Remove hydraulic reservoir/comp. and service to cure hydraulic oil leak prior to DY094.



Thrusters. Thruster 001 was in the Port position prior to first HyBIS dive HY18. Thruster failed during the first dive and it was believed that water had found its way into the thruster and tripped the motor controller. The thruster comp. was not empty. After the dive the thruster was removed, flushed with IPA and left to drain for 24 hours. The thruster was stripped and all the shaft seals and O-rings were replaced. It was noted that the rear shaft bearing was showing signs of corrosion but it was not replaced at that time. The thruster was fitted back onto HyBIS in the Port position for dive HY21.

During HY21 pre-dive checks the thruster initially tripped the motor controller but after power cycling a few times it ran continuously. During dive HY21 the thruster did not work and tripped the motor controller. The motor did not operate during HY22 pre-dive checks or during the dive. The motor did not operate during HY23 pre-dive checks or during the dive. Other notes: Motor removed from HyBIS for dive HY24. Drained and tested using deck lead and worked. Fitted back to vehicle in Port position for HY25 but failed during pre-dive checks. Tested during ascent of dive HY25. Operated for a couple of seconds before cutting out. Motor did not operate during HY26 pre-dive checks or during the dive. Motor did not operate during HY27 pre-dive checks or during the dive.

Thruster 002: Prior to first dive, thruster 002 was the HyBIS spare. It was filled with oil and fitted to HyBIS in the starboard position and was the only thruster fitted for dive HY19. The thruster worked to a water depth of approximately 2000 m before cutting out. The thruster was tested during HY19 post dive checks and ran for a few seconds before tripping thruster controller. We removed the thruster, flushed it with IPA and left it to drain. O-rings and shaft seals were not replaced but the thruster was tested on the floor during HY23 post-dive checks and ran okay, so was filled with fresh oil and re-fitted to HyBIS in the port position for dive HY24. The comp. was also fully drained and filled with fresh oil. It was tested during the ascent of dive HY24, and during post-dive checks, and did not work. An oil leak to the thruster front O-ring was noticed.

During further checks the thruster and hydraulic pump connectors were swapped over. The thruster controls now operated the hydraulic pump and the pump controls turned the thruster, which was as expected and ruled out a control issue within the pressure tubes. The thruster removed to replace leaking front O-ring. While opening the thruster it was noted that the connector feed through into the body was able to turn. The sealing O-rings were checked and looked okay but could not be changed without desoldering the motor windings, and so were not changed. The thruster was re-assembled and tested on deck lead and ran okay. The thruster was left off vehicle and stored in the spares box.

Thruster 005: The thruster was in Starboard position prior to first HyBIS dive HY18. It failed during first dive and as with thruster 001, it was believed that water had found its way into the thruster and tripped the motor controller. The thruster comp. was not empty. After the dive the thruster was removed, flushed with IPA and left to drain. The thruster was stripped and all the shaft seals and O-rings were

replaced. The thruster was tested on the floor between dives using the deck lead and worked so was fitted back onto HyBIS in the Starboard position for dive HY21. The thruster ran okay throughout dive HY21 but during HY22 pre-dive the thruster again cut out and tripped the motor controller. The thruster was left on HyBIS for dive HY22. During ascent to surface thruster was tested and worked okay, however, failed again during HY23 pre-dive checks and HY23 dive. The thruster was left on HyBIS for dive HY24 but failed during the dive and during post-dive checks. During further checks thruster and hydraulic pump connectors were swapped over. The thruster controls now operated the hydraulic pump but the pump controls did not turn the thruster. This was not surprising as thruster was not working at all but showed that it was not a control issue within the pressure tubes. Other notes: Thruster left on HyBIS but did not work during dive HY25. Motor did not operate during HY26 pre-dive checks or during the dive. Motor did not operate during HY27 pre-dive checks or during the dive.

Suggestions/Recommendations. There is an issue with the thrusters that could not be resolved during JC165. The thrusters seem to work intermittently on deck but would not operate underwater. At first it was thought that the problems were the result of water ingress but when stripped down no water could be seen inside, and the thruster comp.s were not losing oil. The resistance of the motor coils was measured at the connector pins and each coil measured approximately 7 Ohms. No short could be measured, although a 'shorting sound' could sometimes be heard from the motor during energization. To test the motors further, they probably need to be operated on the bench, with the high power tube removed, to see what fault appears on the motor controller. Check and replace O-ring spares used on JC165.

Modules. *Sampling* - Not used this cruise. *Downward video* - The downward looking video module was used throughout JC165. The module was fitted with a Super Scorpio HD camera, three Cathyx Aphas lights and two Sidus scaling lasers. *Grab module* - Not used this cruise. *Cameras* - Two Super Scorpio HD cameras with Sony HDR-CX560V were made available from the Isis ROV equipment. Unit Serial# SSC103 was mounted onto HyBIS, while the 2<sup>nd</sup> unit Serial# SSC102 was kept as a spare. The download of images (12 megapixels) required removal of the camera for connection to the main lab control computer and video display. Download time to the computer is 30 minutes for 10 GB. During operations, the Scorpio camera was white balanced to the seabed in the absence of a suitable white surface. This appeared to work sufficiently well to provide realistic image colours. During Dive HY21, on power up there was no Scorpio video feed, but the rattler and a power meter reading of -8dBm proved the Scorpio was being powered and the fibre was in good condition. After a power cycle, the Scorpio video signal returned, but the camera had lost all its settings. It is believed that the battery may have run flat. Two Bowtech PAL cameras were used throughout JC165. No electrical interference was seen as noted during the previous HyBIS cruise JC138.

Suggestions/Recommendations. Investigate if Scorpio CX560VE battery can be replaced (NP-FV50=default, FV70 or FV100)

Super Scorpio Specifications:

HD: 1920 × 1080 / (50P), **50i**, 25p

12.3 MEGA-PIXEL quality for Ultra-High Definition (4672 x 2628-pixel) still images

Sensor: Exmor Back-illuminated CMOS 1/2.88" (6.2mm)

10× Optical Zoom Lens (26.3mm - 263mm in 35mm format)

Focal length f 3.8 - 38mm

Aperture: F1.8 - F9.6

64GB Internal Flash Memory

On recovery, deck download of images (Ethernet deck cable)

*Lights* - For all dives, three downward facing Cathyx Aphos lights were used along with two DSPL LED matrix lights for forward and upward lighting. The lighting circuit was split into two, with the two Aphos downward facing lights on one circuit and the third Aphos plus the two DSPL lights on the second circuit.

During the first dive HY18, the DSPL and 3<sup>rd</sup> Aphos lights went out. After recovery, it was found that a connector to one of the DSPL lights had leaked and shorted out due to a broken cap. After replacing the 10A fuse in telemetry tube and fitting new tails, all the lights work correctly during dive HY21 and onwards.



Suggestions/Recommendations. Consider purchasing DSPL LED Matrix lights for HyBIS when budgets allow, to replace existing halogen lamps. This will help reduce total current drawn by the vehicle and the need to borrow ISIS LED lights for each cruise.

*Scaling Lasers* - Two Isis ROV Sidus lasers were mounted to the HD Scorpio camera to provide 10 cm scaling. These were connected to the switch controlled power supply used for the UHI experiment. During dive HY22 it was noted that the aft laser was producing two dots, one brighter than the other. The laser was removed post dive and a liquid could be seen on the inside of the lens. The laser was dismantled and the liquid appeared to be more like grease from the O-ring seals rather than sea water. The laser was cleaned and re-assembled ready for dive HY23.

Suggestions/Recommendations. Check laser bodies for corrosion. Strip laser to check/replace O-ring seals. Either keep as HyBIS lasers or return to ISIS spares.

*Valeport VA500 Pressure / Altimeter transducers* - Due to the limited RS232 serial ports provided by the fibre optic multiplexor this unit had to be operated in RS485 mode, switchable by a connector short between pins 5 & 9. The resultant data stream suffered from electrical radiated noise generated whenever the thrusters or hydraulics were operated. Re-siting the instrument and cable run had some improvement but continued to be a problem during all dives. This electrical noise had no effect on any of the RS232 channels.

The unit seemed to misbehave and not provide data during the first dive once in the water. Other notes: Spent a morning testing and reconfiguring the altimeter. Reduced the baud rate to 9600 since it is less prone to errors and because the 907 focal board is configured on that baud rate for RS485. Reduced the sampling rate to 1 Hz. Also removed RS485 Address mode since it seemed to confuse the unit if it received a character on the line. This could easily happen on the dive due to noise. On the second dive the altimeter did not start to work until the unit was at 100 m. It performed well for the rest of the dive. It was increased to 2 Hz at the end of the dive to try to increase accuracy due to the heave inherent on HyBIS. For the rest of the dives, the unit functioned correctly. Occasionally it will not output data straight away on power up, but usually after the 100 m depth it starts generating data and work flawlessly for the rest of the dive.

Suggestions/Recommendations. Electrical Interference within HyBIS has been a consistent problem and requires redesign with improved housekeeping to minimise this problem. Consideration to upgrade fibre optic multiplexor to provide additional RS232 channels

*Tritech Sonar* - The HyBIS Tritech Super SeaKing DST sonar (S.N. 244116) was not used during the cruise since the working depth was over the 4000 m water depth rating of the unit.

*Compass* - HyBIS is fitted with an Xsense MTi-30 AHRS, a full gyro-enhanced Attitude and Heading Reference System (AHRS). It outputs drift-free roll, pitch and true/magnetic North referenced yaw. The Xsense is a complex device that requires a calibration process to truly reflect its accuracy within its working location. This had not been achieved before the cruise so differences between ship heading with the vehicle on deck and offsets of USBL tracks were made in the control software data display (-50 degrees).

Suggestions/Recommendations. Investigate and calibrate compass with Xsense software.

*Telemetry Tube* - On Post dive HY19, thanks to time frame and good weather conditions, the telemetry tube was removed from HyBIS. This was necessary to replace the 10 Amp fuse that powers the second group of lights (3<sup>rd</sup> Aphos and the two DSPL).

Power meter / ammeter. This unit was repaired and calibrated back at base. The serial output was connected to the GUI PC to read the current readings. This cruise did not require the use of the hydraulic pumps which are the highest current consumption system. Using the three Cathx lights, 2 DSPL lights, Lasers, Scorpio, 2 PAL cameras, Sensors (telemetry tube + compass + altimeter) the current readings were: Current meter = 2.7-2.9 A @ 237 V. Analog Amppmeter in PSU 5-6 A. This device is designed for high current consumptions, so is normal there is slight difference in low current operations.

Lab Setup and Rack Mount Case. The rack unit was upgraded to a more compact version to facilitate transport and have integrated new W10 computers.



Mini HP GUI Machine. This computer provides monitoring and control of the vehicle. National Instruments Labview code provides for vehicle status displays: Heading & attitude; Turns count;

Pressure; Altimeter; Data logging (1 second time stamped UTC); Ship and vehicle USBL position via ship UDP and Sonardyne Ranger 2 telegram respectively. UDP data broadcast for HD video overlay.

3<sup>rd</sup> party software. Insite GUI and virtual Ethernet device server – Scorpio camera control and image download; Seonet Pro - Tritech obstacle avoidance sonar; Chrome/Firefox – network configuration of AJA KiPro video recorders.

Mini HP OFOP Machine. The OFOP PC was provided along with a second monitor for science logging of ocean floor observations and positioning. Real-time input of ship and HyBIS positions came from ship UDP broadcasts.

AJA KiPro video recorders. Two AJA Rackmounted KiPro units were used to record video, as well as a third unit taken as a spare unit. The Top unit is assigned to the Scorpio HD camera. This feed comes from the overlay, so the user can switch it ON and OFF when required. The overlay has the raw Scorpio SDI signal via a CWDM frequency receiver. The 2<sup>nd</sup> unit is connected to the 720P50 quad which has the two PAL tooling cams. The Apple ProRes 422 codec was employed for all recordings. Approximately every 2 hours during the dive the local cartridge disks would be transferred to the Lacie drives.

HD Video Overlay. The HyBIS video overlay allows the HyBIS topside system to show real time data in one of the HDMI video feeds. The data can come directly from the vehicle or from the ship, GPS or other scientific sensors. During the cruise, this performed well. The error reported on the previous cruise did not appear (intermittent IIC error). During the dives, the display used was the one with “Date, Pressure, numerical Heading and Beacon Position”. During dive HY22 the display with all the feeds was used, and no error appeared.

Suggestions/Recommendations. Investigate IIC error software bug. Modify code to include the altimeter but not big compass.

Topside Fibre optic multiplexor: This 1U unit houses the fibre optic multiplexor with a Focal 907 board and associated power supplies. Connections provided for serial devices and Hydrolek control interface for lights, thrusters, hydraulics and lasers.

UPort 16 port USB RS232 / RS485: This unit is provides the GUI PC with a USB serial expansion to read the sensors data from the Topside Fibre optic multiplexor.

Netgear 8 port switch: This unit provides ROVNET connection for all network devices.

Moxa 2 port serial connected to Shipnet: This unit reads the Sonardyne beacon from the ship and forwards it to the Moxa 4 port.

Moxa 4 port serial to ROVnet: This unit provides for network virtual serial com ports and UDP broadcast. Receives a serial feed and broadcast the info into ROVnet.

Displays: Two Dell 27” monitors for the computer displays and two 28” Samsung TVs mounted on a bespoke frame provide for display of video and PCs. A 23” monitor was used as a second extended display for OFOP for science use to log data and events into the software. A 24” HDMI monitor was used for the Apple mini mac. A CCTV monitor to display the winch CCTV feed for the Winch Operator was supplied by the ship.

Video Archiving / Replay: An Apple mini mac was made available to do the video transferring. It was connected to the two Thunderbolt 2 Lacie 5big 40 TB disk arrays (32 TB available storage on Raid 5). One of the Lacies was the Master and the other a Backup. Finally, an AJA KiPro dock was used to read the cartridges.



Football Floats. Football floats were mobilised with the HyBIS equipment and stowed on board but because only the downward camera module was being used during JC165 and HyBIS would not be landing on the sea bed, the floats were not used.

Sonardyne Beacons. A ship supplied WMT beacon was used for each deployment and routinely charged by the NMF Tech. This provided very good tracking throughout the cruise. The Ranger 2 software was configured with a UDP telegram to output the vehicle position for inclusion in the HyBIS OFOP and data display. Occasionally, the beacon started to divert in a diagonal for about 50 m before coming back to the original position after a couple of seconds. This also happened in the Sonardyne Ranger PC, so the problem has to be related to this machine. Ship Systems Technician believes it is an old computer and Sonardyne should supply a new hardware PC.

Overview/Conclusions. HyBIS performed correctly during all dives, delivering 2631 GB of data which includes 28967 still images and more than 45 hours of video. As a result of the lighting harness failure during the first dive, the lighting conditions were slightly poorer for the first two dives but were still acceptable as sea conditions were not too rough, therefore not much heave. For the rest of the dives all three Aphos lights were used and good lighting levels existed, however, some of the stills images were blurred on a couple of the dives due to a combination of the amount of camera zoom and large heave of the ship.

Although the thrusters were not required for JC165 they did not operate reliably on deck or in the water. The cause of this should be investigated further and remedied prior to its next deployment on DY94. Again, although the hydraulics were not required on JC165 they were tested and suffered from the same reservoir oil leak as observed on JC138. During JC165 the leak was pin-pointed to the joint between the upper and lower halves of the Schilling compensator. Although this could not be fixed during JC165 it should be resolved before DY94.

The new rack setup performed without issues and reduced the complexity of the main lab setup, which was previously done using two laptops. During JC165, both HyBISs Techs worked the same 12 hr shift and the HyBIS vehicle was disconnected from the deep tow cable after each dive. It was not possible to work an offset shift pattern since some of the pre and post dive tasks required both technicians such as connecting and disconnecting the deep tow cable, pre and post dive checks and the post-dive maintenance. Doing one dive every two days allowed longer effective dive times, with the following day being used to do the post dive maintenance, Scorpio data download and preparations for the next dive. Occasionally dives were made on consecutive days, but this resulted in slightly shorter dives due to post and pre-dive checks having to be fitted into the same 12 hour shift.

The only other issue that affected the HyBIS performance was damage to the fibre optic tails. The tails are very delicate and it was found that even when placed inside the protective sleeve during the swapping of ship's cables, they would tie themselves into knots. The likelihood of damage is increased each time the fibre optic terminations are removed and then re-connected to the HV junction box. This risk was highlighted prior to the cruise and two re-terminations had to be made during operations. The re-terminations did have an impact on the dives length, however, this was kept to a minimum. Overall, HyBIS was successfully deployed for the PAP JC165 cruise, and delivered the video, data and photos that the science party needed for their research.

## **HyBIS Dive Summaries**

### 24/05/18 HY18

Water depth 4825 m; 08:10 In water; 10:20 Seabed; 15:15 Off Seabed; 17:00 On Surface; 17:10 On Deck; In water time 8:50 hours; On bottom time 4:55 hours.



Started at 06:00. 1hr to feed cable through sleeve. 1hr to connect it to HyBIS + do PreDive.

08:15 Pressure sensor not working

08:45 Checked calibration of the power/current monitor of the 240V/HV PSU. Calibration OK. Energized thrusters briefly and they interfere with PAL signal (loose camera feed).

09:00 At 1100m, Lost 3<sup>rd</sup> Aphos and DSPL. Cameras are still on, but not able to see anything.

09:40 Tried to run thrusters, no current is drawn neither sound heard on Scorpio.

Tried the hydraulic pump, no current is drawn neither sound heard on Scorpio.

09:50 Power cycle done. 3<sup>rd</sup> Aphos and DSPL still not working.

Tried the hydraulic pump, 15 Amps current is drawn and sound heard on Scorpio.

Tried to run thrusters, no current is drawn neither sound heard on Scorpio (a brief glitch can be seen on the cameras)

Tried again the hydraulic pump. This time, did not work. Disabled due to the thrusters.

10:21 Scorpio White Balance. Set at 5 second interval.

11:00 Changed Scorpio to Manual Focus + Far to prevent blurring. Scorpio was also zoomed in, so pictures are now slightly darker due to less Aperture.

12:25 Ki pro Scorpio tape change (78% free, 110 GB).

15:15 End of dive. Off Bottom

16:35 At 1000m, turn off |Scorpio and lights.

HV Power Off and Isolation.

Post Dive Data Summary: Scorpio Video 267.59 GB; Download Scorpio Images 3069 files 9.64 GB;

Text log files with GUI Compass and OFOP

Post Dive Notes: Scorpio seems to work better with Autofocus due to the heave movement.

### 26/05/18 HY19

Water depth 4825 m; 07:45 In water; 09:38 Seabed; 16:40 Off Seabed; 18:35 On Surface; 18:45 On Deck; In water time 10:50 hours; On bottom time 7:02 hours

Post Dive Data Summary: Scorpio Video 371.65 GB; PAL Video 95.63 GB; Download Scorpio Images 4547 files, 14.9 GB; Text log files with GUI Compass and OFOP

Post Dive Notes:

07:50 All sensors working. Initially altimeter was not working but started to give correct data at 100m. Starboard thruster is OK (is the spare unit.) No Port thruster fitted on this dive.

09:30 Rotated HyBIS to remove turns. The PAL cameras now only just blink slight due to the noise, but no as cutting out as the previous dive. The altimeter/depth sensor is lost when thruster is used, but comes back OK.

09:40 Ship Beacon is sometimes erratic. Checking if Pole has been lowered.

09:38 On Bottom, 4825m

White Balance Scorpio

Started recording both Ki Pro (recording the Quad jus to see how much it uses in **720p**).

09:40 Moving to Waypoint 6 at 0.4 Knots

10:00 Thruster stopped working.

11:15 Reached Waypoint 6. Extending 200m at 0.3

11:30 Lost Altimeter

11:45 Ki Pro Tape Change. Scorpio is 78% free of 500GB, (110 GB used)

Quad is 62% free of 250GB (95 GB used).

11:58 Altimeter has come back

13:45 Ki Pro Tape Change

15:47 Ki Pro Tape Change

16:10 Waypoint 10 reached.

16:30 Stopped Logging GUI. Changed altimeter refresh from 1 Hz to 2Hz. Keep the 9600 baud rate.

16:40 End of Dive. Off Bottom.  
 17:57 Lost comms and video for 10 seconds (Scorpio, PAL and data) Came back.  
 17:59 Lost comms and video (Scorpio, PAL and data)  
 18:01 Video and data came back (1100m depth)  
 18:35 On Surface

Post dive Thruster resistance measurements

Thruster SN#001 (just serviced on post dive with new seals and dried)

1&2	7 Ohm	2&3	7.4 Ohm	1&3	7.7 Ohm		
1&4	5.9 MOhm		2&4	5.9 MOhm		3&4	5.9 MOhm

Thruster SN#005 (dried but to be serviced ???)

1&2	7.4 Ohm	2&3	7.1 Ohm	1&3	7.1 Ohm		
1&4	Inf MOhm		2&4	Inf MOhm		3&4	Inf MOhm

Thruster SN#002 (still on the vehicle, probably flooded, needs removal and service)

1&2	6.9 Ohm	2&3	6.2 Ohm	1&3	4.8 Ohm		
1&4	17 MOhm		2&4	17 MOhm		3&4	17MOhm

28/05/18 HY20 - Aborted with comms problem.

Post Dive Notes:

08:25 Power up. Scorpio OK. No telemetry neither PAL cameras.  
 Quickly measured with the power meter -> Scorpio -8dBm. Telemetry Low/No dBm.  
 Power cycle but no change.  
 Abort dive.

Isolation .

09:00 Power readings from F.O termination HyBIS to F.O JB of Main lab. Transmitter sends -7dBm.

	1310 nm	1550 nm	
Red	Low/No dBm	Low/No dBm	dBm
Grey	-15.0 dBm (8.86dB)		-17 dBm(10dB)
Black	Low/No dBm	Low/No dBm	dBm

OTDR from Main Lab

Red	9.4350 km
Grey	9.4370 km
Black	9.4442 km

OTDR from HyBIS

Red (Red cable tie for Vehicle Telemetry)	0m BAD
Grey (Green cable tie for Scorpio)	9.4380 km
Black (Black cable tie)	0m BAD

Cut off Red and Black fibres. The green was left since it had good readings.  
 Could only redo the red since black was too short for a new tail fusion splicing.

10:00 OTDR from HyBIS Red -> GOOD. 9.4330 km

Power readings from F.O termination HyBIS to F.O JB of Main lab. Transmitter sends -7dBm.

	1310 nm	1550 nm
Red	-14.0 dBm (7.1dB)	-16.2 dBm(9.3dB)
Grey	-16.0 dBm (9.1dB)	-17.4 dBm(10.4dB)
Black(NA)		

28/05/18 HY21

Water depth 4840 m; 10:58 In water; 13:02 Seabed; 16:47 Off Seabed; 18:38 On Surface; 18:45 On Deck; In water time 7:40 hours; On bottom time 3:45 hours

Post Dive Data Summary: Scorpio Video 197.8GB; Download Scorpio Images 2375 files, 7.53 GB; Text log files with GUI Compass and OFOP.

Post Dive Notes: Using FO Grey for Scorpio. New fusion spliced FO Red for Telemetry. FO Black not available.

11:05 Power Up. Telemetry OK.  
Got telemetry but no scorpio. Rattler did show between -10/-15 dBm and power meter -8dBm.  
11:10 Power cycle. Telemetry OK. Scorpio now OK but came with default initial screen.  
Seems the Scorpio camera battery was flat.  
Investigate if Scorpio CX560VE battery can be replaced (NP-FV50=default, FV70 or FV100)  
12:40 4200m tried Stbd thruster. OK and no noise in cameras.  
12:50 Cable out 4700. Alt/Depth sensor report 4806 decibar = 4712m.  
13:02 On Seabed 4840 m  
White balance scorpio, snaps timer 5 seconds and start recorder.  
3 Cathx, 2 DSPL, Lasers, Scorpio, 2 PAL cameras, Sensors (telemetry tube + compass + altimeter) on:  
Current meter says 2.7-2.9A @ 237V. Analog Ampmeter in PSU says 5-6A.  
13:05 Start towards WPT 12 at 0.4 Knots.

No issues so far with the overlay. Problem resolved due to new rack setup? We are using the display with Date, Pressure, Heading and Beacon Position. No Big compass.  
Could modify code to include the altimeter but not big compass.

14:30 Reached WPT 12, extending another 200m.  
14:50 End extension. Moving to WPT 13.  
15:15 Reached WPT 13, starting new transect towards WPT 14 at 0.4.  
16:26 Reached WPT 14, extending another 200m.  
16:47 End of Dive. OFF Bottom.  
18:25 Power Off  
18:35 On Surface

### 30/05/18 HY22

Water depth 4832 m; 10:30 In water; 12:24 Seabed 4832 m; 16:27 Off Seabed; 18:15 On Surface; 18:20 On Deck; In water time 7:45 hours; On bottom time 4:03 hours

Post Dive Data Summary: Scorpio Video 211.8 GB; Download Scorpio Images 2528 files, 8.4 GB; Text log files with GUI Compass and OFOP.

Post Dive Notes: Delay due to problems with winch scrolling and coring cable.

09:10 got donkey tube at deck  
09:45 Power readings from F.O termination HyBIS to F.O JB of Main lab. Transmitter sends -7dBm.  
1310 nm 1550 nm  
Red -14.0 dBm (7dB) -16.7 dBm(9.7dB)  
Grey -20.0 dBm (13dB) -21 dBm(14dB)  
Black (NA)  
10:30 Start Deployment  
10:35 Power Up. Scorpio and sensors except altimeter. Scorpio rattler has power LED + 2 LEDs for signal.

Altimeter is not sending ascii string. Press "sync" for couple of seconds and came back to live.

10:35 Started recording Quad to observe hyd comp relief valve if it leaks.

11:25 2200m depth. Starting to see hydraulic comp go down and to see oil bubbles in the camera but not from schilling comp pressure relief.

11:45 3400m. Hydraulic comp almost empty

12:24 On Bottom, 4832 m. Scorpio WB and every 5 seconds. Recording Ki Pro.

12:30 Start going to WPT 15 at 0.4 Knots

13:04 Rubbish on seabed.

14:05 WPT 16 reached, extending.

14:25 Starting from WPT 17 to WPT 18 at 0.4 kn

16:15 Reached WPT 18.

16:27 End of Dive. Off Bottom

16:32 Tried thrusters. Starboard OK. Port cut offs.

16:33 Power cycle. Tried again and Starboard OK. Port cut offs.

17:57 Power off.

18:15 On Surface

31/05/18 HY23

Water depth 4800 m; 10:40 In water; 12:42 Seabed; 16:17 Off Seabed; 18:10 On Surface; 18:15 On Deck; In water time 7:30 hours; On bottom time 3:35 hours.

Post Dive Data Summary: Scorpio Video 187.3 GB; Download Scorpio Images 2247 files, 7.7 GB; Text log files with GUI Compass and OFOP.

#### Post Dive Notes

06:00 Scorpio download.

06:45 Connected umbilical and started pre dive.  
Had telemetry but no scorpio video feed. Rattler only showd Power LED but no signal levels.  
Cleaning tails did bring Scorpio video but was flickering and intermittent.  
Measured power meter reading, had -20 dBm. Clearly too low, so fibre diagnosed as faulty.

07:15? Started to re do full termination.  
Power readings from F.O termination from workshop to F.O JB of Main lab. Transmitter sends -7dBm.

	1310 nm	1550 nm
Red	-14.0 dBm (7dB)	-16 dBm(9dB)
Grey	-16.3 dBm (9.5dB)	-18 dBm(11dB)
Black	-15.3 dBm (8.6dB)	-20 dBm(13dB)

10:10 Reconnected umbilical to HyBIS. Used Red for Vehicle Telemetry and Grey for Scorpio.  
Power on Deck lead.  
Everything fine. Scorpio rattler has power LED + 2 LEDs for signal.  
Pre Dive.

10:40 In Water

10:44 Power On. Everything OK except Altimeter. Tried to press Sync but nothing.

10:50 Altimeter started to work on its own at 100m.

10:55 Overlay set to show all sensor data to see if we get IRC error as previous cruise.

12:42 On Bottom. 4800m. Scorpio WB, Ki Pro recording.  
Moving to WPT 20 at 0.5  
Laser bottom unit has "two dots".

14:26 Reached WPT21, moving to WPT 22 at 0.5 kn

16:17 End of Dive. Off Bottom  
Zoomed in on Scorpio and took some snap shots to see diffraction of the lasers.

17:55 Power Off

18:10 On Surface

03/06/18 HY24

Water depth 4806 m; 08:15 In water; 10:10 Seabed; 16:30 Off Seabed; 18:15 On Surface; 18:20 On Deck; In water time 10:00 hours; On bottom time 6:20 hours.

Post Dive Data Summary: Scorpio Video 336.8 GB; Download Scorpio Images 4000 files, 13.4 GB; Text log files with GUI Compass and OFOP.

Post Dive Notes

7:00

Power readings from HyBIS HV JB to F.O JB of Main lab. Transmitter sends -7dBm.

	1310 nm	1550 nm
Red	-14.6 dBm (7.8dB)	-16.6 dBm(9.7dB)
Grey	-15.2 dBm (8.5dB)	-17.3 dBm(10.3dB)
Black	-16.2 dBm (9.3dB)	-20.7 dBm(13.7dB)

08:15 In Water

08:20 Power Up. All sensors working except altimeter

08:26 Altimeter started working at 100m

09:25 2700m. Hyd Comp has not really moved, only a little bit probably to air in the system.

09:30 2900m. Some oil could be seen coming out from the hydraulic comp underside, where the band clamps hold on the end cap.

10:10 On Bottom. 4806m. Scorpio WB. Timer 5 seconds.

10:12 WPT 23 moving to WLT 24 at 0.5 Kts. Later slowed down to 0.4.

11:22 Reached WPT24, extending.

11:44 End of Line. Moving to WPT 26 at 0.4

13:40 Reached WPT26 and extending.

14:05 WPT 27, start of new line at 0.4 Kts.

15:43 End of line. Going to WPT29 at 0.3kt. Later increased to 0.4 and 0.5 Kts.

16:30 End of Dive. Off Bottom at 4767m

Thruster test, both cut.

16:50 Power cycle, changed Topside box. Hydraulics worked fine; thrusters till cut.

18:00 Power Down

18:15 On Surface

06/06/18 HY25

Water depth 4802 m; 10:43 In water; 12:39 Seabed; 18:18 Off Seabed; 20:02 On Surface; 20:05 On Deck; In water time 09:19 hours; On bottom time 5:39 hours.

Post Dive Data Summary: Scorpio Video 300.6 GB; Download Scorpio Images 3542 files, 11.5 GB; Text log files with GUI Compass and OFOP.

Post Dive Notes

Started 7am

Power readings from HyBIS HV JB to F.O JB of Main lab. Transmitter sends -7dBm.

	1310 nm	1550 nm
Red	-14.3 dBm (7.5dB)	-17.3 dBm(10.3dB)
Grey	-15.5 dBm (8.7dB)	-17.7 dBm(10.5dB)
Black	Not Tested	Not Tested

10:43 In Water  
10:49 Power up. All sensors, including the altimeter  
At 1000m, started recording Quad to observe leak.  
12:10 3500m No apparent leaks on hyd comp  
12:16 Big oil bubble  
12:25 Starting to leak at higher speed.  
12:39 At bottom, 4802m. Scorpio WB and 5 second timer. Moving to WPT 32 at 0.4 Kts.  
12:45 Ki Pro recording  
12:56 Hyd Comp empty  
14:21 Moving to WPT33 at 0.3, later 0.4 Kts  
14:46 Reached WP33, moving to WPT 34.  
16:39 Reached WPT35, moving to WPT36 at 0.5 Kts  
17:46 Reached WPT36, extending 200m.  
18:18 End of Dive, off bottom  
18:21 Tested thrusters. Starboard did not work. Port come on for a second.  
19:47 Power Off  
20:02 On Surface

08/06/18 HY26

Water depth 4805 m; 06:47 In water; 08:42 Seabed; 16:30 Off Seabed; 18:23 On Surface; 18:25 On Deck; In water time 11:36 hours; On bottom time 7:48 hours.

Post Dive Data Summary: Scorpio Video 419.65 GB; Download Scorpio Images 4929 files, 15.6 GB; Text log files with GUI Compass and OFOP.

Post Dive Notes

Started 6am

Power readings from HyBIS HV JB to F.O JB of Main lab. Transmitter sends -7dBm.

	1310 nm	1550 nm
Red	-14 dBm (7.2dB)	-16.6 dBm(9.6dB)
Grey	-15.7 dBm (8.9dB)	-17.8 dBm(10.7dB)
Black	Not Tested	Not Tested

06:47 In Water  
06:56 Power Up. Everything OK.  
08:42 On bottom, 4805m. Scorpio WB. Ki Pro Recording  
09:00 Moving to WPT1, 800m, 65deg, 0.3Kts  
10:45 End of line, moving 270deg. Tape Change  
11:20 New move, 245 deg, 0.4kts  
12:50 New move, 30 deg. Tape Change  
13:12 Moving now on 65 deg at 0.3kts  
14:51 Going due North, 1000m. Tape Chage  
16:30 End of dive.  
No coring to be done after HyBIS, so no need to disconnect the Deep Tow Cable.

09/06/18 HY27

Water depth 4270 m; 09:52 In water; 11:43 Seabed; 14:30 Off Seabed; 16:00 On Surface; 16:05 On Deck; In water time 6:08 hours; On bottom time 2:47 hours.

Post Dive Data Summary: Scorpio Video 146.8 GB; Download Scorpio Images 1730 files, 6.38 GB; Text log files with GUI Compass and OFOP.

Post Dive Notes

Since the vehicle had not been disconnected from the Deep Tow Cable, no F.O. readings were made.

09:52 In Water  
09:56 Power Up. All Sensors and video OK.  
11:43 On Bottom, 4270m. Scorpio WB, Ki Pro recording  
11:44 Move 2000m on bearing 112 deg at 0.4 Kts  
13:10 Depth 3950m  
14:30 End of Dive. Off Bottom  
16:00 On Surface.

## **9. Other NMF equipment**

PAP Mooring Winch Inv No 250009419. This was used with ship's deck hydraulic supply. It operated OK for PAP mooring deployment and recovery of old rope with some scrolling issues. Occasionally the scroll carriage would stop when it reached the LH end and not restart in the opposite direction after the dwell period. The operation/adjustment of the scroll carriage proximity switches requires looking at when the drum is empty as it would appear the “back up” stop is being activated instead of the “normal” end stop switch. The slew ring gear wheel was greased at the end of cruise. There was a very slight seepage of hydraulic oil noted from RH brake casing joint.

North Sea Winches Inv Nos 250008826 & 250008823. Both winches operated without problems during cruise. 250008823 requires repainting.

OTSB Trawls. 2 × trawls were carried out using the same net, net appears to still be in good condition (“black netting” one). See later section for deployment details.

Liquid Nitrogen Generator (LN2-02 - orange) Inv No 250001592. Not used. Unit to be overhauled & fitted new type dewar after cruise.

Megacorer. This operated well during cruise. One slider plate c/w with springs replaced plus one top flap spindle bush. The following additional spares are recommended for the spares box; Swager for repairing nylon lanyards (swage fittings already in spares). Solvent cleaner and superglue for re-fixing sample tube locking collars.

Portable Fume Cupboard Bioquell Monair 1250 Plus Inv No 250006807. This was used for duration of cruise without problems.

Millipore Integral 15 Inv Nos 260004512 & 250009175. Both systems were used for duration of cruise without problems. No maintenance carried out other than routine CL2 cleans on both systems. Consumables used: 1 x Q gard filter pack.

Scotsman Icemaker Inv No 250008452. The icemaker operated without problems during cruise.



## 10. Scientific Ship Systems

Scientific Ship Systems (SSS) is responsible for managing the Ship's network infrastructure, data acquisition, compilation and delivery, the email system and a range of ship-fitted instruments and sensors. All times in this report are UTC.

### Scientific Computer Systems

Acquisition: Network drives were setup on the on-board file server; firstly a read-only drive of the ship's instruments data and a second scratch drive for the scientific party. Both were combined at the end of the cruise and copied to disks for the PSO and BODC. The Ship-fitted instruments that were logged are listed in the below file (includes BODC/Level-C notes): 'JC165\_Ship\_fitted\_information\_sheet.docx' Cruise Disk Location: 'JC165/CRUISE\_REPORTS/'. Data were logged by the Techsas 5.11 data acquisition system. The system creates NetCDF and ASCII output data files. The format of the data files is given per instrument in the "Data Description" directory: Cruise Disk Location: 'JC165/Ship\_Systems/TECHSAS/Data Description/'. Data was additionally logged into the legacy RVS Level-C format, which is also described in the *NMFSS\_NetCDF\_Description\_Cook\_v2\_2.docx* document. There are ASCII dumps of all the Level-C streams included on the data disk in the directory: Cruise Disk Location: 'JC165/Ship\_Systems/Level-C/pro\_data/ascii/'.

Main Acquisition Events/Data Losses: 6<sup>th</sup> June 2018 – Network and router reboot led to a data gap between 11:35 – 11:45. 9<sup>th</sup> June 2018 – SurfMet was unresponsive from 08:30 – 09:15, when the system was reset.

Internet provision: Satellite Communications were provided with both the Vsat and Fleet Broadband (FBB) systems. The Vsat had a guaranteed speed of 1.5 Mbps, bursts greater than this when there is space on the satellite, and unlimited data. The FBB had a maximum un-guaranteed speed of 256 kbps with a fair use policy that equates to 15 GB of data a month. There was solid service throughout, interrupted with a few mast blockages when on a northerly heading. Unrestricted internet was provided during mobilisation. On sailing, the restricted system was in place throughout the ship. A six-hour captive portal was used. An unrestricted Wi-Fi hot spot was trialled in the lounge/bar, with a one-hour captive portal.

Email provision: E-mail communications were primarily provided by whitelisting institutional pages and encouraging their use through Outlook and Apple Mail desktop clients. AMS was set-up as a back-up service for all UK institutional addresses supplied.

Outreach provision: A trial was undertaken to live-stream HyBIS video footage to the internet. This was put to good effect on World Ocean Day (08/06/2018), when around 500 visitors tuned in to watch the mission.

## Instrumentation

Position and attitude - GPS and attitude measurement systems were run throughout the cruise. The *Applanix POSMV* system is the vessel's primary GPS system, outputting the position of the ship's common reference point in the gravity meter room. The POSMV is available to be sent to all systems and is repeated around the vessel. The position fixes attitude and gyro data are logged to the Techsas system. True Heave is logged by the Kongsberg EM122 & EM710 systems. The *Kongsberg Seapath 300+* system is the vessel's secondary GPS system. This was the position and attitude source that was initially used by the EM122 & EM710 due to its superior real-time heave data. Position fixes and attitude data are logged to the Techsas system. The *CNav 3050* GPS system is the vessel's differential correction service. It provides the Applanix POSMV and Seapath330+ system with RTCM DGPS corrections (greater than 1 m accuracy). The position fixes data are logged to the Techsas system.

Meteorology and sea surface monitoring package - The NMF Surfmet system was run throughout the cruise, excepting times for cleaning, entering and leaving port and whilst alongside. Please see the separate information sheet for details of the sensors used and whether calibrations values have been applied: 'JC165\_Surfmet\_sensor\_information\_sheet.docx', Cruise Disk Location: 'JC165/CRUISE\_REPORTS/'. Friday 25<sup>th</sup> May 2018 14:00 – Following a sensor mix-up it was noticed that the Skye PAR starboard sensor was out of calibration. The sensor was replaced with a newly calibrated one – see the calibration sheets. PAR 28563 (exp 13/05/2018) was replaced with PAR 28556 (exp 07/11/2019). Saturday 9<sup>th</sup> June 2018 08:30 – 09:15: SurfMet was unresponsive and values during this period should be disregarded. Instrument calibration sheets are included in the directory: Cruise Disk Location: 'JC165/Ship\_Systems/Met/SURFMET/calibrations/'.

### Non-Toxic Seawater SystemEvents:

Date	Start Time	Stop Time	Cleaned	Transmissivity (v)			Fluro
				Norm	High	Low	
Non-Toxic started on departing GBSOU							
19/05/2018	17:30	--	Yes	3.9020	4.648	0.0586	0.1736
26/05/2018	--	08:58					
26/25/2018	09:37		Yes	4.2560	4.6422	0.0592	0.2600
02/06/2018	--	12:25					
02/06/2018	13:12		Yes	4.1904	4.6367	0.0586	0.1131
Non-Toxic stopped on evening of Monday 11 <sup>th</sup> June							

Drop Keel Sound Velocity Sensor - The surface Sound Velocity (SV) sensor (AML SmartSV) mounted on the drop keel was used throughout providing SV data to the EM122. The port drop keel remained flush with the hull for the duration of the cruise.

Kongsberg EA640 10/12 kHz Single-beam - The EA640 single-beam echo-sounder was run throughout the cruise. The 10 kHz was run in free-running mode, while the 12 kHz remained in passive. Pulse parameters were altered during the cruise in response to changing depth. It was used with a constant sound velocity of 1500 ms<sup>-1</sup> throughout the water column to allow it to be corrected for sound velocity in post processing. Kongsberg Raw files and History BMP files are logged and depths were logged to Techsas and Level-C.

Kongsberg EM122 multi-beam echo sounder - The EM122 multibeam echo-sounder was run throughout the cruise in free-running mode. The position and attitude data were initially supplied from the Seapath 300+ due to its superior real-time heave. Sound velocity profiles were input from full depth CTD casts. When these were not available sound velocity was derived from a statistical model using Ifremer's DORIS programme. The following figures show the system installation configuration. The values are from the ships Parker survey report, which is included on the data disk. The attitude angular corrections for use with the Seapath 300+ system were derived from a post refit trial calibration on JC108 Sept 2014. The attitude angular corrections for use with the Applanix Posmv system are from calibration during JC103 May 2014.

EM122 TRANSDUCER LOCATIONS				EM122 TRANSDUCER OFFSETS			
Location offset (m)				Offset angles (deg.)			
	Forward (X)	Starboard (Y)	Downward (Z)		Roll	Pitch	Heading
Pos, COM1:	0.00	0.00	0.00	TX Transducer:	-0.083	-0.235	0.182
Pos, COM3:	0.00	0.00	0.00	RX Transducer:	-0.063	0.034	0.133
Pos, COM4/UDP2:	0.00	0.00	0.00	Attitude 1, COM2/UDP5:	0.15	0.12	-0.2
TX Transducer:	19.199	1.832	6.944	Attitude 2, COM3/UDP6:	0.06	-0.04	0.03
RX Transducer:	14.092	0.954	6.926	Stand-alone Heading:			0.00
Attitude 1, COM2/UDP5:	0.00	0.00	0.00				
Attitude 2, COM3/UDP6:	-0.350	0.056	-0.373				
Waterline:			0.368				

Sound velocity profiles - Sound velocity profiles were derived from data from the CTD. These were processed with Sea Bird data processing, followed by Ifremer's DORIS programme. These were input to the EM122 and the Sonardyne USBL when required. Cruise Disk Location: 'JC165/Ship\_Systems/Acoustics/Sound\_Velocity\_Profiles/'.

ADCPs - Both the 75 and 150 kHz were run initially, with the 150 kHz being run consistently during the cruise. All acoustics were turned off during mooring release. Set-up: Free-running, bottom track off, drop keel flush with the hull, broadband mode.

**Wamos Wave Radar** -The Wamos wave radar was run throughout the cruise but the system is currently not calibrated and over-reading wave height. Summary data files (including Significant wave height and period) were transferred to the cruise data disk. Cruise Disk Location: 'JC165/Ship\_Systems/Met/Wamos/'. The intention was to calibrate this system against the PAP buoy, but it was subsequently found that the PAP buoy's own wave recorder was out of service.

EM Speed logs - The single axis bridge Skipper Log and the dual axis Chernikeef science log were logged throughout the cruise. The Chernikeef log was calibrated in December 2017 offshore of Tenerife with an additional adjustment on 21/03/2018 as below.

RPM	True Speed	True Speed (21/03/18)	Measured Speed
R0030	S0301	0274	A0079
R0050	S0500	0455	A0126
R0080	S0767	0698	A0192
R0110	S1015	0924	A0257
R0001	N/A	S0001	A0001
R0140	N/A	S1617	A0450

**Sonardyne USBL** - WMT beacons were fixed to the Mega-core frame and HyBIS. These data were recorded in Techsas.

**CTD2MET** - CTD profiles were converted and thinned to be ingested into the Met Office CTD2MET programme. This was done for the full depth CTD casts.

## 11. PAP1 - Observatory scientific report

Sue Hartman, Corinne Pebody, Chris Caldwell, Jon Cambell,  
Amine Gana, Charlotte Miskin-Hymas

### General Description

The PAP1 system comprises sensors connected to either a buoy telemetry electronics unit or a frame data hub unit and their data is sent using Iridium to our server at NOC. The telemetry communication is intended to provide remote quasi-real time data. Schematic drawings of these two units as configured for the latest deployment are shown below. The buoy also hosts an entirely separate system provided by the UK Met Office, which has its own telemetry unit and a suite of meteorological sensors measuring wind velocity, wave spectra and atmospheric pressure.

The last PAP1 system was deployed on April 18<sup>th</sup> 2017 on RRS *Discovery* cruise DY077. In this document, we describe the status of the system that was recovered and the new set of electronics and sensors that will be acquiring data for a year between 2018 and 2019. The Met Office buoy was reused for the JC165 deployment, as were many of the clamps on the keel; however, all of the ropes are new. In 2017 the buoy had been painted with an antifouling coating to decrease biofouling, the new keel that was deployed in 2018 was painted at NOC before sailing. Most of the clamps on the keel have been reused this year. The clamps that need to be changed next year are for the GTD and CO<sub>2</sub> sensors (on the keel and frame) as these sensors have decreased in size, rubber sheet has been used to fit the available clamps this year. The phosphate sensor might also require a new clamping system that will hold it more securely.

There are minor sensor changes compared to last year, the CO<sub>2</sub> sensor on the keel is now able to measure atmospheric CO<sub>2</sub> in addition to water. The load cell is not being deployed this year because when the frame from DY077 was recovered, it was observed that the load cell might have been hitting the sensors at the top of the frame, possibly, from when the chain had slack. In addition, no data were obtained from the load cell deployed last year. The pH sensor Sensor Lab SP101-Sm has leaked and is not being redeployed this year.

The previous PAP#1 Observatory system was deployed on April 18<sup>th</sup> 2017 on cruise DY077. In this document, we describe the status of the system that was recovered from the deployment in 2017 and the systems that were deployed in 2018. We describe the observatory including the changes to the telemetry and data hub systems. A section is devoted to the calibration and configuration of the deployed sensors. We include a description of the status of the observatory after recovery and post-deployment calibration of the sensors that were recovered during this cruise.

## **Deployed Observatory Description**

Data Hub and Telemetry units - There are two virtually identical telemetry units, and similarly two data hubs which were developed and first deployed in 2014. Both units are normally swapped each year, but this year it was decided to redeploy the data hub that was recovered on 23<sup>rd</sup> May. This was because the other data hub had a malfunctioning compass/pitch/roll sensor. All 4 of these units are based around the Persistor microcontroller which is no longer available as the company closed in 2017. As a result of this, the OTE Group is planning to develop replacement systems based around their widely used SAM4L technology. The majority of sensors on the keel and frame have been tested at NOC along with the Iridium satellite communications. The clamping of the sensors on the frame and keel has been conducted on the ship. The plan for next year is to test and clamp all the sensors at NOC, this will allow for a tank test to be performed where the frame can be tested in the water in order to test leaking failures. It is not the case this year, but usually a sensor or harness fails during deployment due to water leaks. This can be avoided by performing a water test for a week. In addition, by clamping the sensors at NOC and allocating their battery housing, this will avoid changing harnesses and connectors on the ship.

To decrease the chances of harness failure we had the harnesses externally manufactured by a company with cable manufacturing expertise to increase the reliability and decrease the cost and manufacturing time. A few changes were made to the harnesses during the expedition mainly due to swapping battery housings of different sensors such as the SeaFET and the SUNA on the frame. The SeaFET on the keel required an extension in order to reach its battery housing. The pumps that connect to the CO<sub>2</sub> sensors did not have harnesses provided by the manufacturer and had to be made.

Software and Hardware Updates - A duplicate of the current system was used for the 2018 deployment, illustrated below to show the systems connected. The differences between the two electronics are minimal.

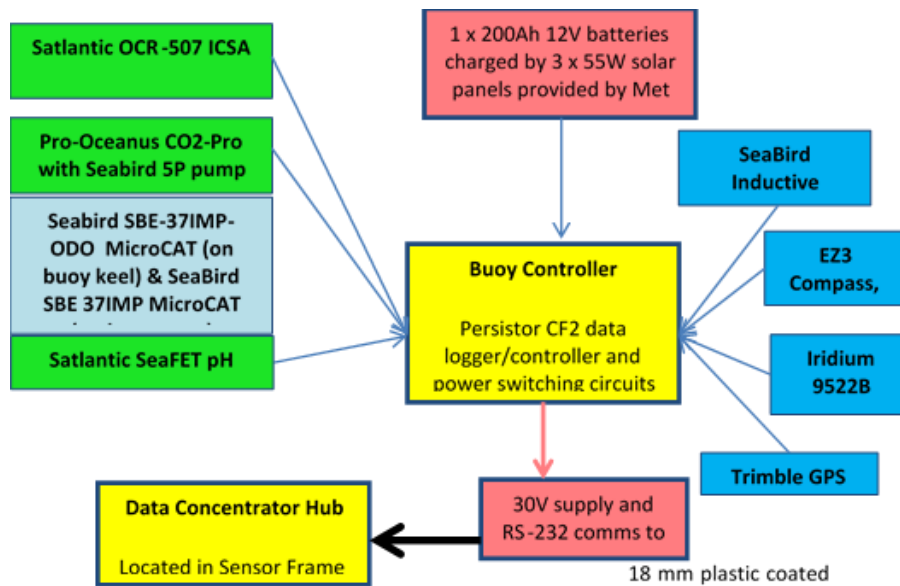

It was necessary to make a small modification to one of the RS232 transceiver devices that is used in both the data hubs and telemetry units. The original circuit connected this device so that it went to sleep when there was no RS232 activity, but this was found to be incompatible with the newer Pro-Oceanus sensors. The change consisted of disabling the auto-shutdown feature by connecting pins 22 and 23 to VREG. This change needs to be implemented on the recovered telemetry unit before the 2019 deployment. On the other hand, it is critical that the data from the CO<sub>2</sub> and GTD sensors are transmitted to the server to get real-time CO<sub>2</sub> and pressure data.

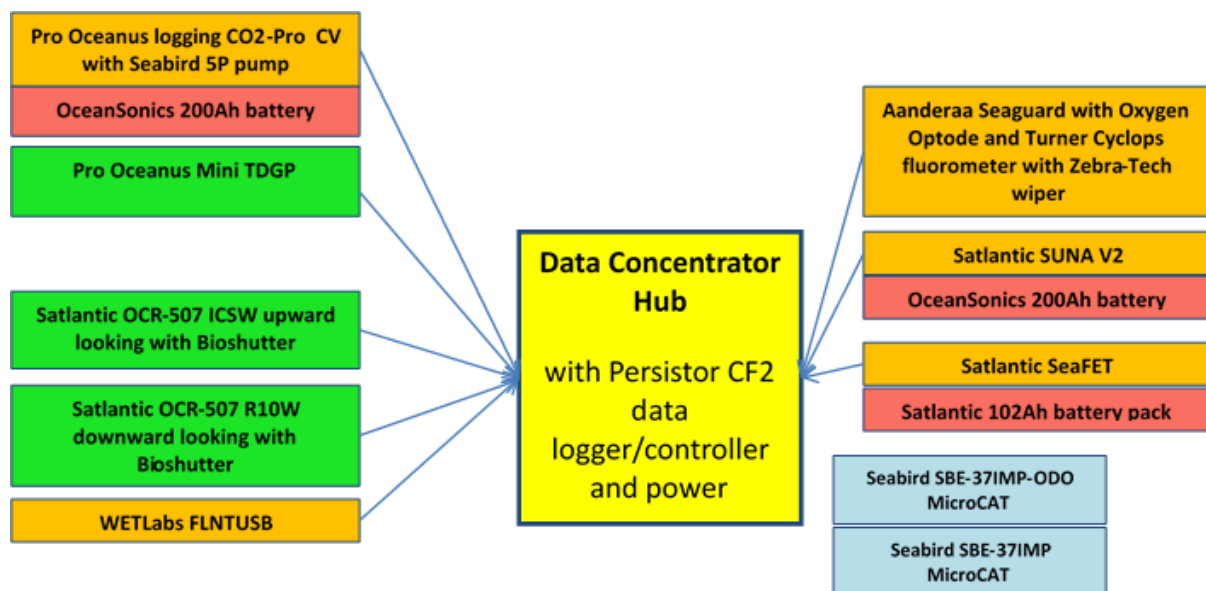

Software changes for 2018 deployment - The only significant software changes for this deployment were to accommodate new Pro-Oceanus sensors. A CO<sub>2</sub>-Pro with atmospheric option was fitted on the

buoy keel and a Mini-TDGP (Total Dissolved Gas Pressure) sensor was installed in the frame. Four new 'data types' were created for these sensors: COA, COB, COC, TDG, where:

COA is for the atmospheric CO<sub>2</sub> data

COB is the in-water CO<sub>2</sub> on the buoy

COC is the in-water CO<sub>2</sub> on the frame

TDG is the total dissolved gas pressure on the frame

In order to accommodate these new data types, the message processing program on the Iridium server at NOC (PAP\_2018dep\_proc.exe) had already been modified before the cruise. The formats of the telemetered data are described in a document 'PAP Mooring NOCS data formats June 2018.docx'. There is a long-standing problem with the software function that decodes messages from the Seaguard sensor which affects the first message after every day change. This has not been fixed, but the Iridium server processing has been modified to ignore the first message after a day change. The data recorded internally in the Seaguard are not affected by this issue.



## Deployment and initial performance

The PAP#1 deployment commenced at 08:00 4<sup>th</sup> June 2018 (day 155) and continued smoothly until the anchor was released at 14:43. Data telemetered to NOC from the buoy were accessed via FTP using the ship's internet connection and indicated that all the sensors were functioning. Once the frame was in the water, e-mail commands were sent to switch on the Data Hub, the Satlantic OCR irradiance sensors, and the CO<sub>2</sub> sensor on the keel.

Sensor Configuration for deployment 2018-2019 is shown below.

Sensor	Serial Number	Intervals (hours)	Minutes after hour
<b>BUOY</b>			
Pro-Oceanus CO2-Atmos	33-201-45	12	11
SeaBird SBE-37-ODO-IMP MicroCAT	16503	0.5	0
Satlantic OCR-507 ICSA (buoy) with bioshutter	201	0.5	17
SeaBird SBE-37-IMP MicroCAT (on mast to give approximate air temperature)	6915	0.25	0
Satlantic SeaFET pH	105	0.5	27
<b>FRAME</b>			
SeaBird SBE-37-ODO-IMP MicroCAT	10315	0.5	0
SeaBird SBE-37-IMP MicroCAT	6904	0.25	0
WETLabs FLNTUSB Fluorometer	269	4	0
Satlantic SUNA Nitrate sensor	698	1	20
Satlantic SeaFET pH sensor	111	0.5	23
Aanderaa 4430H Seaguard	2075	1	30
Aanderaa 4330 optode in Seaguard	2824	1	30
Turner Cyclops Fluorometer in Seaguard	21100373	1	30
ZebraTech Wiper for Cyclops	NA	6	0
Satlantic OCR-507 ICSW irradiance (upwards) with Bioshutter	200	0.5	17
Satlantic OCR-507 R10W radiance (downwards) with bioshutter	113	0.5	17
Pro-Oceanus Logging CO2-CV	33-146-45	12	52
Pro-Oceanus GTD-mini	38-506-31	0.5	21
WETLabs CYCL-P Phosphate Analyser	458	6	20

The figures below illustrate the status of the observatory and some of the parameters during the first days of deployment. We observe the same patterns as in the previous years, which imply that the observatory is progressing as expected. There is a periodic behaviour coming that depends on the daily recharge of the solar panels and the schedule of the sensor measurements.

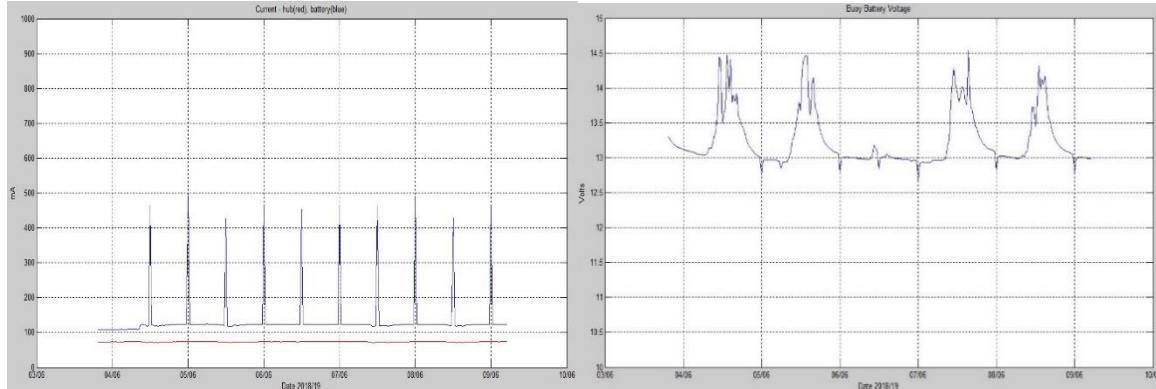

*Left: current consumption of buoy and data hub. Right: voltage of buoy batteries*

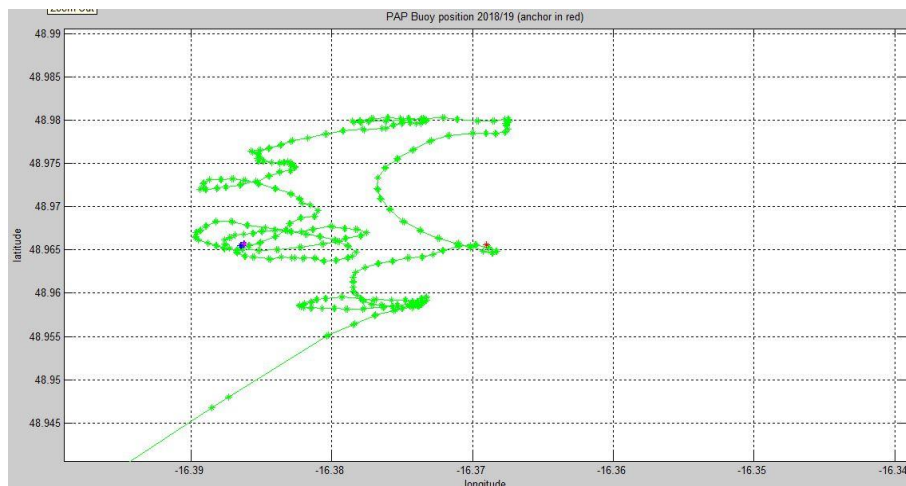

*Buoy positions around the anchor*

## Deployed PAP1 Sensors

Aanderaa Seaguard - A new Seaguard instrument (4430H, SN 2075) was acquired for JC165. It has an Oxygen optode (Aanderaa 4330, SN 2824) and fluorometer (Turner cyclops, SN 21100373). These were prepared for deployment as part of the PAP#1 sensor frame. Initial set-up and preliminary checks in the lab and whilst on board showed the Seaguard to be in proper working order and correctly communicating with the central Hub of PAP#1.

Pre-deployment calibration of Seaguard: The Seaguard was placed on a 100 m CTD cast (station number 003). On this pre-deployment calibration the Seaguard took the place of one of the 10 L Niskin bottles. The Turner Cyclops fluorometer was mounted on the top bar facing upwards out of the CTD rosette. Waters were collected from Niskin bottles and later analysed through Winkler titration for

dissolved oxygen to calibrate the Aanderaa optode. The Turner Cyclops fluorometer was also calibrated against water samples that were analysed by a lab based Turner Trilogy unit. There was no RCM unit on the new instrument. The oxygen data (using  $\mu\text{mol L}^{-1}$ ) units) were compared to the concentrations measured by the Winkler technique. Optode 2824 claibration:

$$\text{O}_2 (\mu\text{mol/l}) = 0.6199 * \text{output} (\mu\text{mol/l}) + 67.369, R^2 = 0.999$$

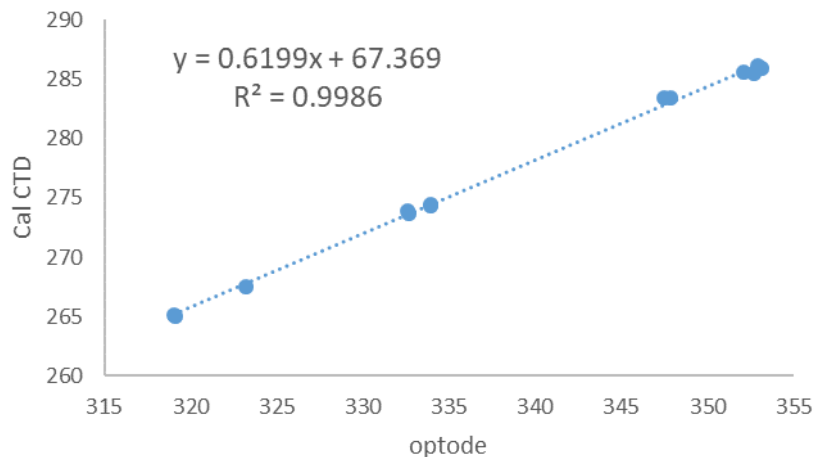

Ideally the oxygen data from the Seaguard should be corrected for pressure and salinity using the equations provided in the optode manual (this would correct the data to  $\mu\text{mol/kg}$ , the SI unit). The depth and salinity readings could be taken from the CTD graphs, plus temperature data taken from the optode. However, as this is not done with the real time data it would not be a meaningful calibration to apply. Please note that the calibration above is based on  $\mu\text{mol/l}$  units.

### Seaguard sn2075 pre dep cal

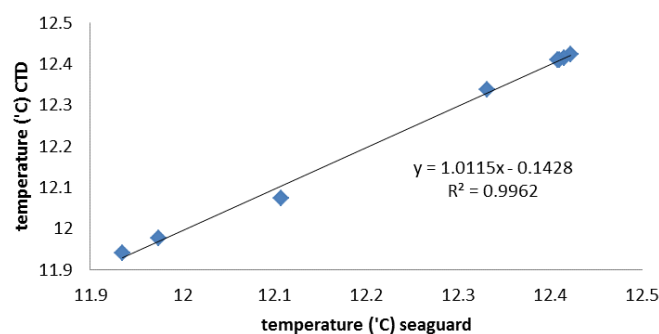

$$\text{Temperature calibration (}^\circ\text{C)} = \text{sguard} \times 1.0115 - 0.1428, (R^2 = 0.996)$$

The Seaguard SN 2075 Turner fluorometer was calibrated on CTD05 (JC165-12) along with the recovered WETlabs fluorometer. It was set up initially on CTD 03 but the channel for the cyclops fluorometer had been changed from 4 to 1 on the new instrument and this had not been picked up on programming. The fluorometer was set at a gain setting of 10, this is high for the PAP-SO and when the recovered instrument is sent for servicing the gain should be decreased. However, the calibrations were good (see section on wetlabs fluorometer to be deployed for description of calibration technique).



Turner calibration: chlorophyll (mg/m<sup>3</sup>) = sguard × 0.057 + 0.1056, (R<sup>2</sup> = 0.926)

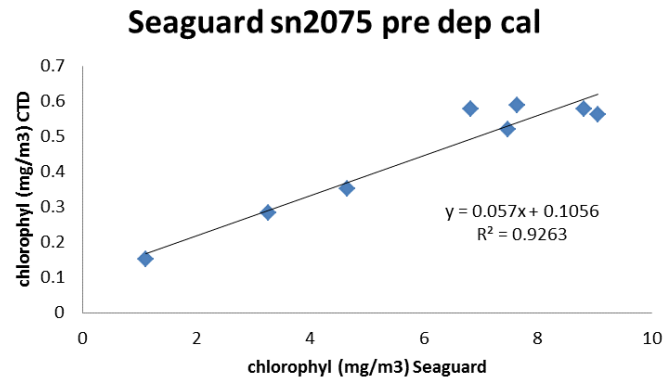

The Seaguard is powered by an internal battery and is connected to the sensor frame Datahub via cable harness 'C'.



*The Seaguard ready to deploy (note bracket is secure).*



*The Turner Fluorometer and zebra tech wiper pre-deployment.*

The scheduling for deployment was to perform a measurement every hour on the half hour, so as to spread inputs to the Hub. The unit was armed to start operating before deployment to ensure correct communication to the Hub, time, and date. The Cyclops Turner fluorometer was mounted in the ZebraTech wiper and set to activate every 6 hrs. Having the wiper activate near the hour meant that

there was the minimum chance that a wipe could happen at the same time as a measurement by the fluorometer, although the wiper time would have to drift well beyond specification for this to be a problem. The wiper was checked 6 hours later and correctly performed a wipe.

The Seaguard was set-up and secured in its pressure housing. The unit was then integrated into the sensor frame.

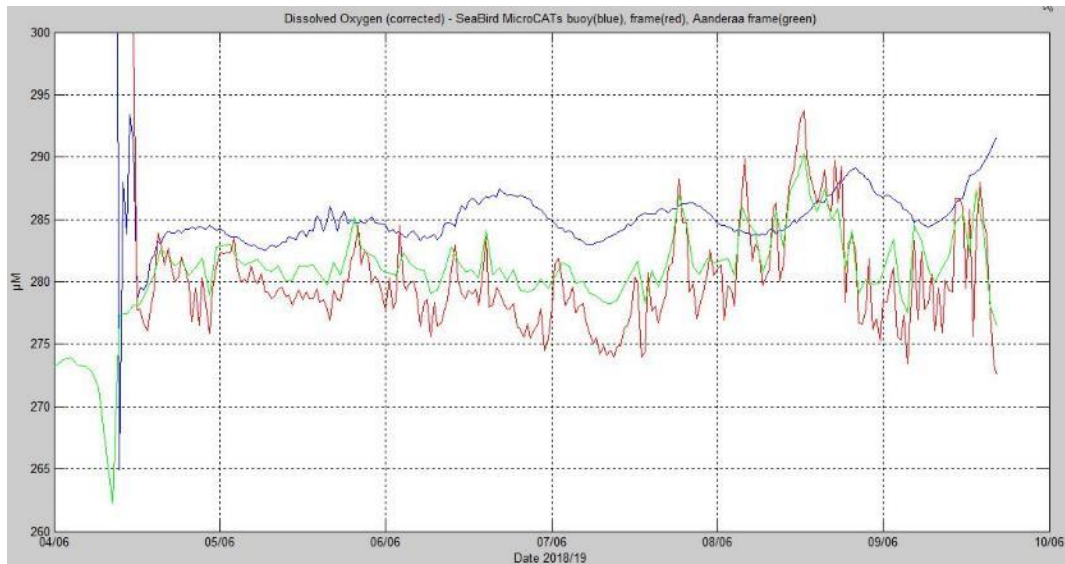

*Oxygen data from the Seaguard (and seabird microcats) a few days after deployment.*

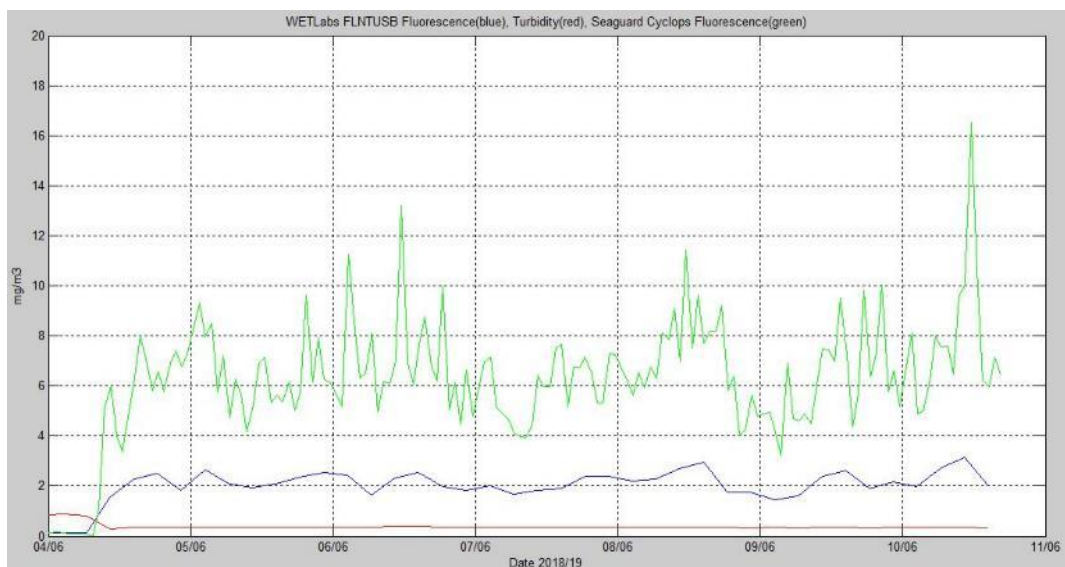

*Uncalibrated fluorescence from the first days of deployment of the Wetlabs and Turner fluorometers*

### **SUNA Nitrate Sensor**

SUNA pre-deployment calibration - Pre calibration of the SUNA nitrate sensor SN698 (JC165 Frame) was at SATLANTIC August 2017. This was checked in the lab March 2018 and on JC165 using the same standards (all are summarised below). The SUNA was run in continuous mode, set up in a 2 L measuring cylinder containing in turn DIW, approx. 5  $\mu\text{M}$  and 10  $\mu\text{M}$  standards (measured at NOC,

then frozen post cal to be measured again at NOC). The standards were prepared using a nitrate standard stock and artificial sea water (ASW; salinity 40 psu). Performance of the instrument in de-ionised water (DIW) was also checked. The exact concentrations of all the calibration solutions will be determined using a Nutrient AutoAnalyser at National Oceanography Centre, Southampton.

Preliminary calibration results including manufacturer’s calibration are shown in the table and figure below.

	11/8/17	21/3/18	21/5/18
DIW		-0.16	1.8 adjust to 0.04
SW	0.3		
NO <sub>3</sub> 40 uM	1.35		
NO <sub>3</sub> 5.22 uM	39.88	6.32	5.2
NO <sub>3</sub> 10.75 uM		11.49	10.6

An approximate calibration (until the standards are measured on the auto analyser) is:

$$\text{Nitrate } (\mu\text{mol/l}) = 1.0241 \times \text{suna output} - 0.1052$$

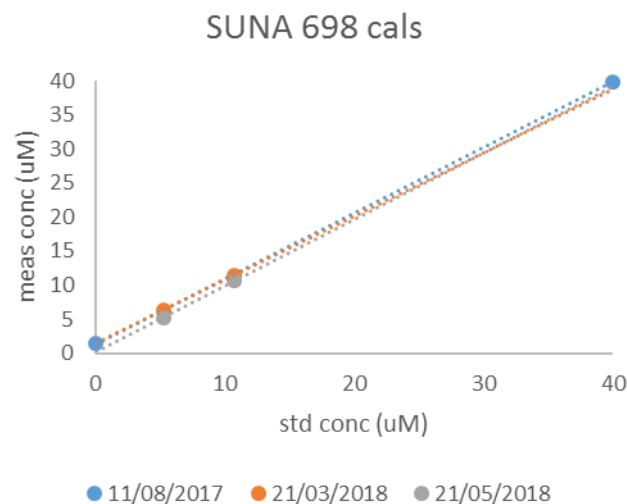

*Pre-deployment calibration of SUNA SN 698 nitrate sensor JC165*

SUNA deployment on the sensor frame - On the sensor frame deployed at 30 m, the SUNA Nitrate sensor was configured to sample in a periodic mode/frame based operation. The sampling interval was set to 1 hour with 1200 sec (20 min) offset past the hour. Within the sampling interval, the acquisition duration was given by the number of frames. For this deployment, the chosen 1 frame operation outputs 1 dark frame then 1 light frame which is the average of 10 samples. This gives an estimated frame rate of 0.1587 frames per second (6.3 sec/frame). The integrated wiper was enabled.

Screen shots of the SUNA settings for deployment:

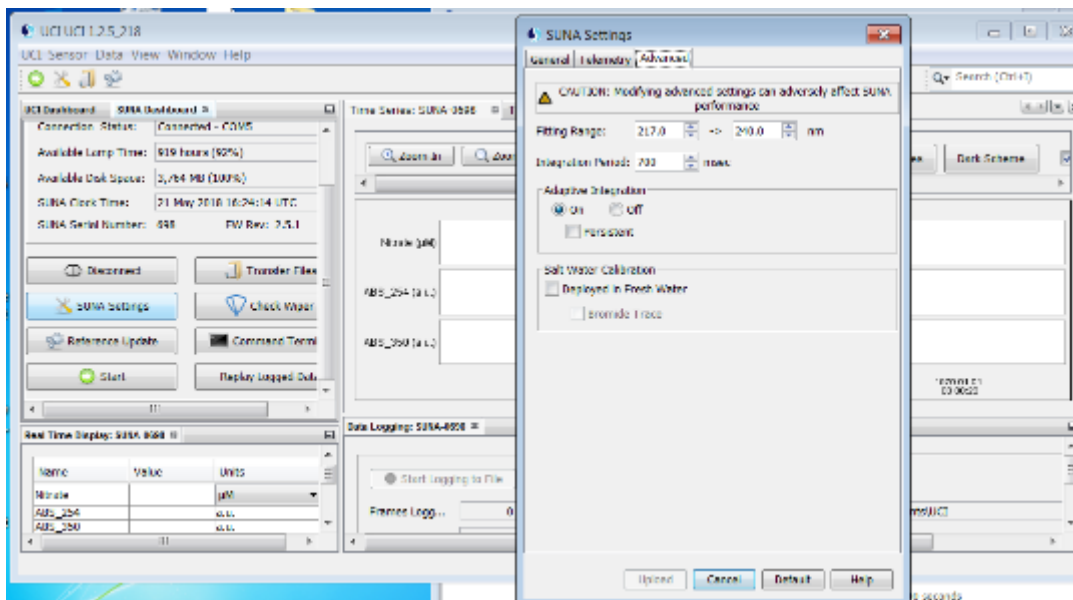
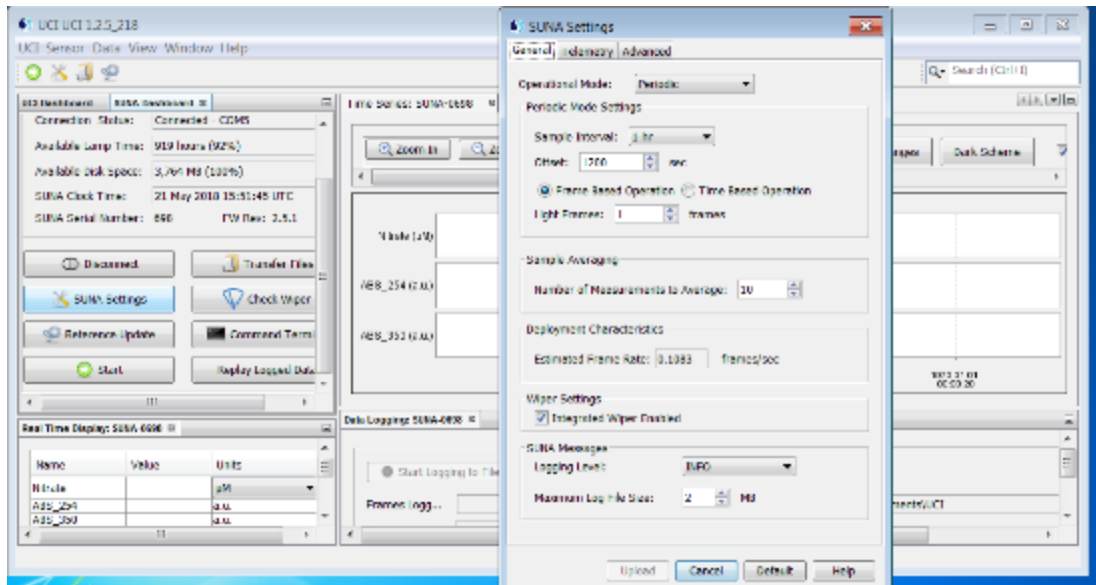

Note that the deployed SUNA has a note to telemeter ‘Concentration’ and record ‘full ascii’ (so this has been changed on the new SUNA SN698 before deployment). The SUNA 698 also had an integration period of 700 (500 in the instructions).



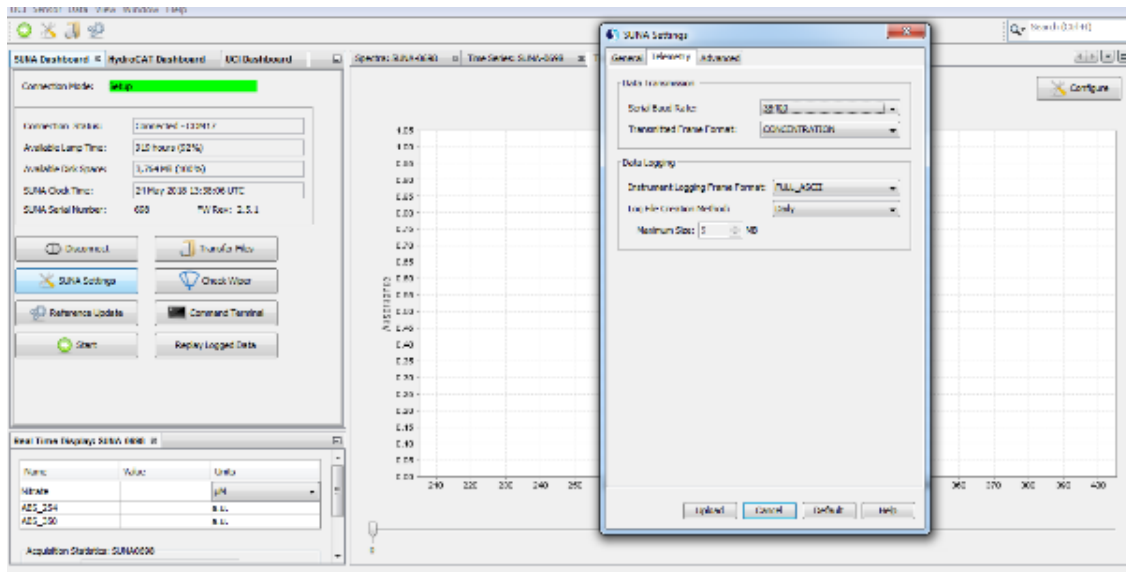

*Satlantic SUNA SN 698 nitrate sensor (the metal cased one), with integrated wiper ready to be deployed on a sensor frame*

The SUNA is powered by an OceanSonics OS200 battery (S/N 2343) providing a voltage of approximately 14.4 V and 228 Ah and is connected to the sensor frame Datahub via cable harness 'D'.

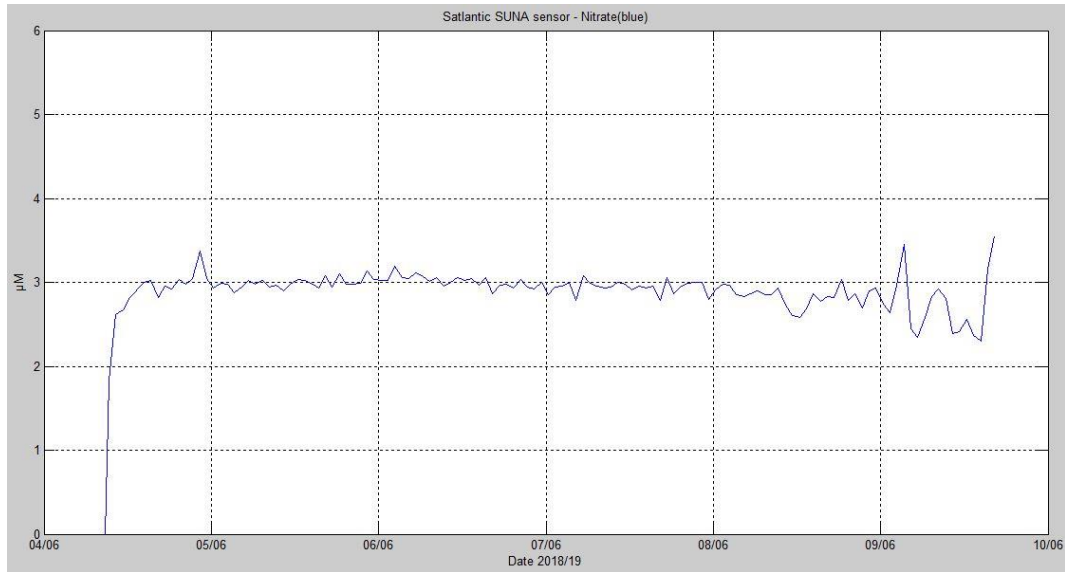

*Measurements during first days of deployment*

**WETLabs Fluorometer**

**wetlabs sn 269 pre dep cal  
calibration**

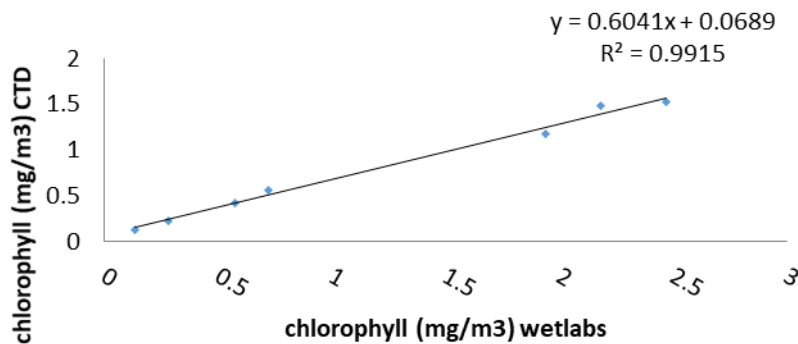

*Pre deployment calibrations (CTD 05) and bench tests of the Wetlabs FLNTSUB SN 269 for deployment on JC165.*

The wetlabs 269 was bench tested prior to embarkation and was further calibrated by deployment on CTD 3. The factory calibrations were applied.

The Characterization sheet is as follows: SN 269

Thermistor calibration: temperature = (output × slope) + intercept

Where slope = -0.0057 °C/count and intercept = 71.5456 °C

Pressure sensor calibration: pressure = (output × slope) + intercept

Where slope = 0.033 dBar/count and intercept = -4.61 dBar

Chlorophyll Scale Factor:  $Chl(\mu g/l) = Scale\ Factor \times (output - dark\ counts)$

Where scale factor = 0.0098  $\mu g/l/V$  and dark counts = 54 counts

Nephelometric Turbidity Unit (NTU) Scale Factor =  $Scale\ Factor \times (output - dark\ counts)$ . Where scale factor = 0.0066NTU/V and dark counts = 73 counts).

The chlorophyll sensor performed reasonably well and the backscatter was recorded too. The Niskin bottles were sampled and the filters were analysed on board on a bench top Trilogy fluorometer (NOC id- black 01) from Turner. Chlorophyll samples were taken at all of the shallow CTDs and selected Niskin bottles on the deep. Samples were filtered through 25 mm gffs. Early samples were frozen first, later samples were placed immediately into 8 ml of acetone overnight and analysed through the black 01 trilogy. There was some variability in the results as the equipment and filtering system were perfected. Early variability introduced by not shaking the bottles was noted and corrected for later casts and the procedure was perfected to produce an  $R^2$  of 0.992.

The instrument was positioned in the frame so the cone sample area would not be compromised by the framework (see picture below). The WETLabs Fluorometer is powered by an internal battery and is connected to the sensor frame Datahub via cable harness 'C'.



*The Wetlabs FLNTSUB with copper and measurement window facing out of the frame.*

### **Sea-Bird SBE 37 MicroCATs**

The SBE sensors (SN 16503, 10315, 6904, 6915) were attached to the CTD (cast 003) and calibrated down to 100 m with sampling intervals of 10 s. The sensors were serviced prior to the cruise. SN 16503 (buoy) and SN 10315 (frame) measure oxygen. The oxygen calibration was checked against the CTD oxygen (calibrated to Winkler oxygen samples on board). The sensors were characterized at sea on a shallow CTD (cast 003) to 100 m, which is the maximum depth rating for these sensors.

Results from the oxygen sensors on the seabird microcats can be adjusted to the calibrated CTD results as follows:

#### *Pre-deployment calibrations:*

Seabird SN 16503       $O_2$  ( $\mu\text{mol/l}$ ) =  $0.923 \times \text{output} (\mu\text{mol/l}) + 29.999$ ,  $R^2 = 0.995$

Seabird SN10315       $O_2$  ( $\mu\text{mol/l}$ ) =  $1.3254 \times \text{output} (\mu\text{mol/l}) - 90.611$ ,  $R^2 = 0.814$

Note that the linear fit for the calibration of Seabird SN10315 is relatively poor and only the top 60 m of data could be used. This probably implies that the sensor is only good to 60m (not 100m as stated).

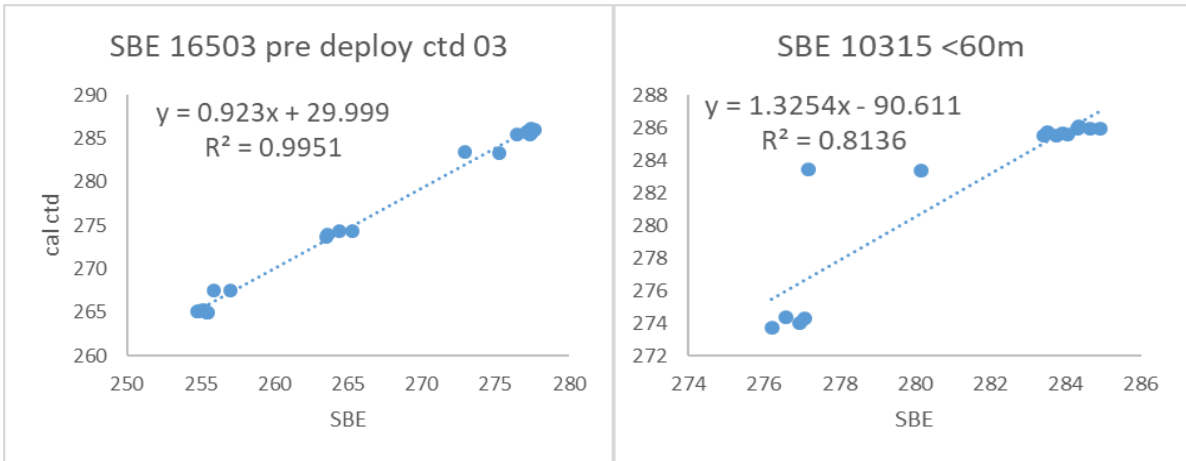

The SBE 37 sensors were connectect to the sensor frame (S/N 10315 and 6904), the ODAS buoy keel (S/N 16503) and on the ODAS buoy mast (S/N 6915). All sensors are connected to the buoy Telemetry Hub inductively and are powered internally.

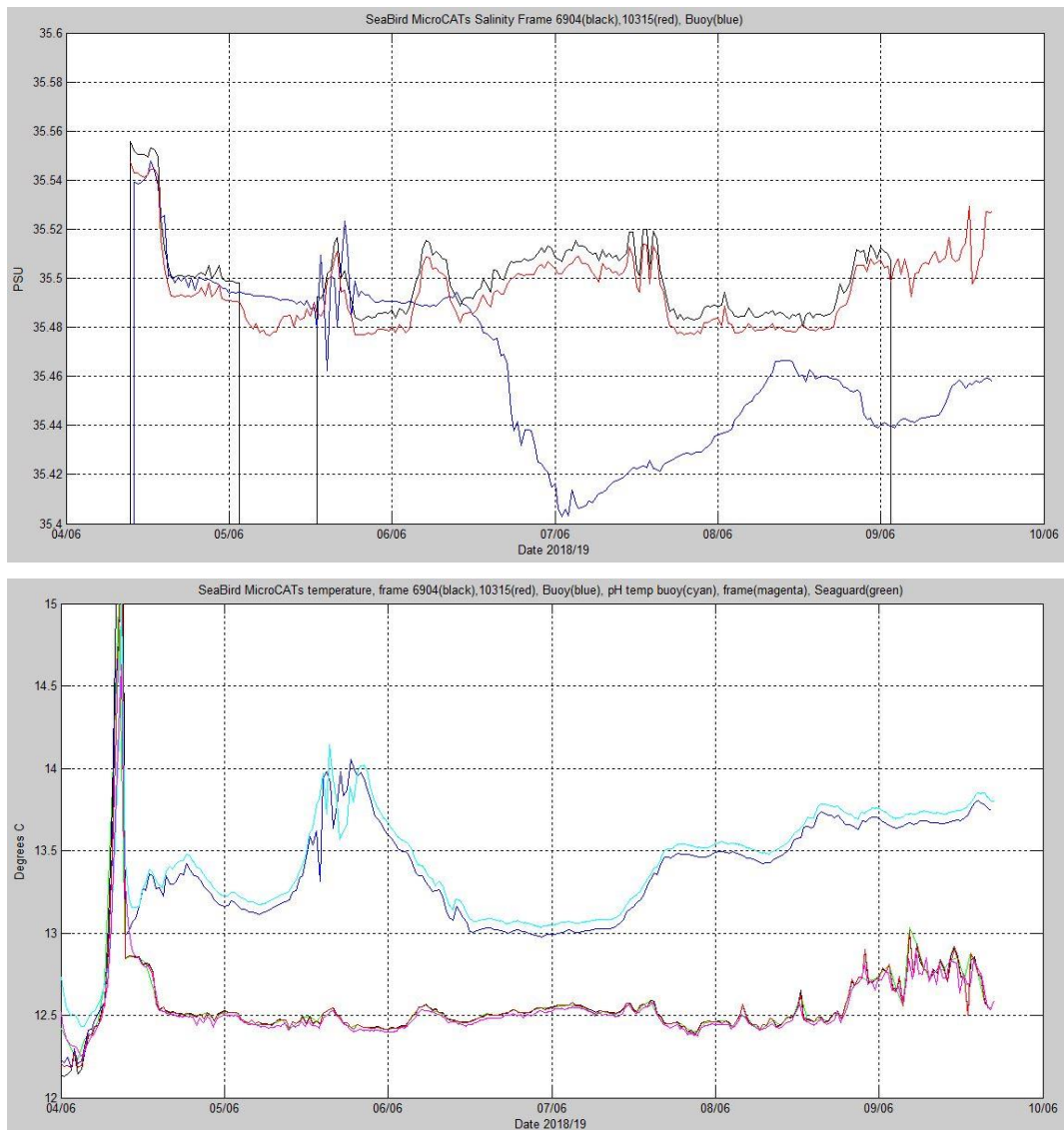

*Initial salinity and temperature data*

### **Pro-Oceanus dissolved gas sensors**

CO<sub>2</sub> sensor on the buoy - The new atmos Pro-oceanus CO<sub>2</sub> sensor was deployed on the buoy (SN 33-201-45). It was set up to read CO<sub>2</sub> data twice a day (every 12 hours). This sensor is different to that deployed in previous years as it has the ability to measure CO<sub>2</sub> concentrations above the sea surface as well as measuring at the sensor position (1 m below surface). To facilitate this, two lengths of yellow garden hose were passed from the keel space to upper buoy mast to protect the gas tubes on the sensor. The top housing was mounted to a clamp plate and fixed to the inner top rail of the mast.



*Pro-CO<sub>2</sub> atmospheric unit showing pump and Pro-CO<sub>2</sub> unit on the keel and atmospheric CO<sub>2</sub> unit attached to the top of the buoy.*

Auto Zero Point Calibrations (AZPC) was set up to occur every 24 hours. However, the zero did not happen at all on the buoy CO<sub>2</sub> sensor and the manufacturers admitted a firmware issue. They suggested that the data would be retrievable and that we try 23 hours in future. The figure below shows the initial performance of the CO<sub>2</sub> sensor after deployment.

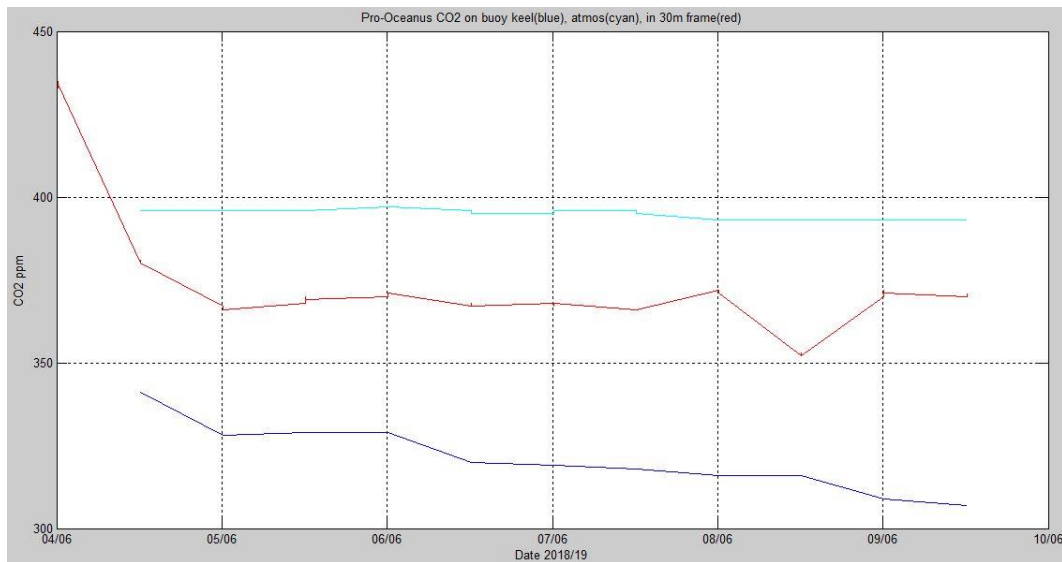

*CO<sub>2</sub> measurements from the buoy and frame during the first days of deployment.*

The buoy CO<sub>2</sub> sensor is connected to the Telemetry Hub directly, via cable harness 'BuoyCO<sub>2</sub>'. Power is supplied by the Telemetry Unit and the SeaBird pump is powered from the CO<sub>2</sub> sensor itself.



CO<sub>2</sub> sensor on the frame - A new self-logging Pro-Oceanus CV CO<sub>2</sub> sensor was deployed on the frame (SN 33-146-45). It was configured for twice a day readings (every 12 hours).



*Pro-CO<sub>2</sub> CV on the frame – with pump attached just before deployment.*

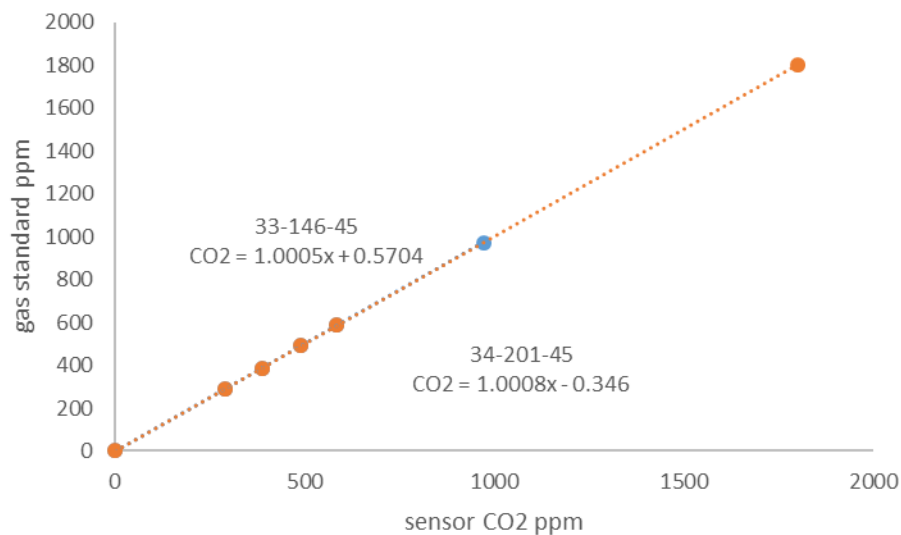

*Manufacturers calibrations against gas standards, to show the Pro-Oceanus calibration for a) SN 33-146-45 on the 25<sup>th</sup> July 2017 and b) SN 33-201-45 on the 22<sup>nd</sup> August 2017*

The frame mounted CO<sub>2</sub> sensor is powered by an OceanSonics OS200 battery (S/N 2342, situated in the middle of the three OceanSonics housings on the frame) providing a voltage of approximately 14.4 V and 228 Ah and is connected to the sensor frame Datahub via cable harness 'C'. The sensor took a zero reading twice a day (See below).

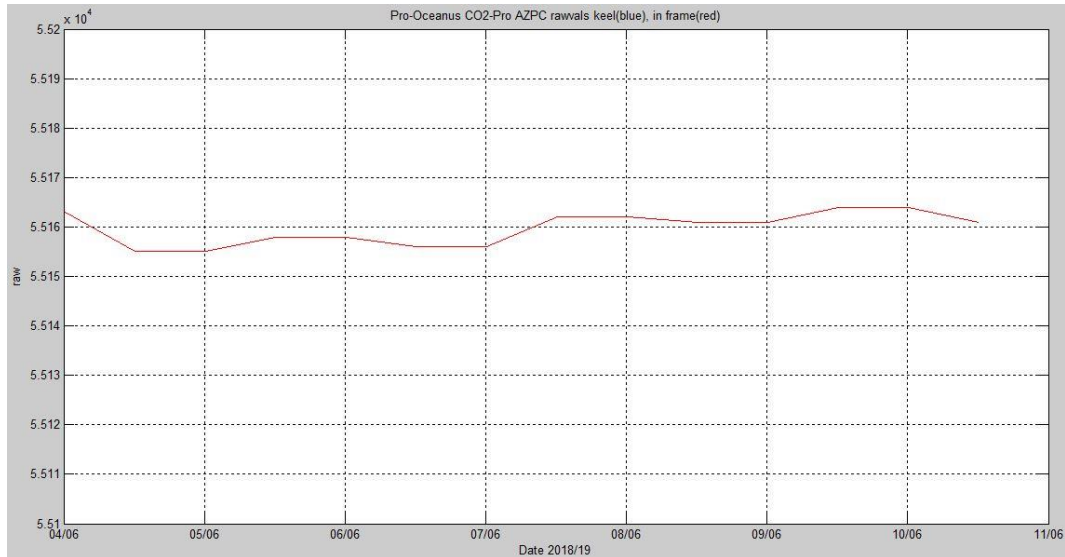

*Zero readings from the frame CO<sub>2</sub> sensor on the first few days after deployment.*

GTD sensor on the frame - A mini GTD-Pro gas tension sensor (SN 38-506-31) was attached to the sensor frame. It has a copper mesh over the membrane. It was set to log every half hour. The GTD sensor is powered by a Satlantic 102 Ah battery (S/N 314) and is connected to the sensor frame Datahub via cable harness 'C'.



*The mini-GTD on the frame pre-deployment JC165.*



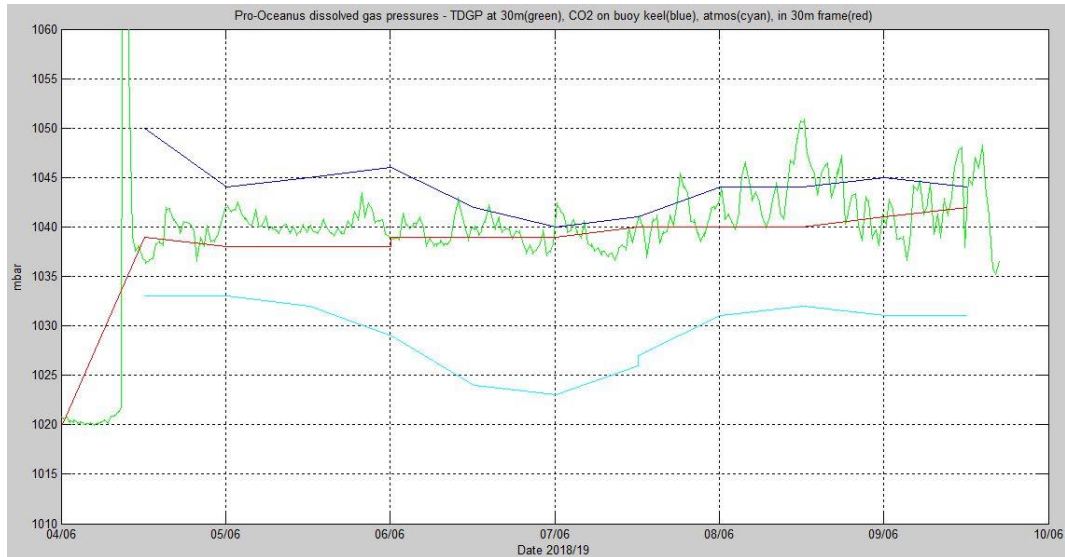

*Pressure during the first days of deployment from the GTD and CO<sub>2</sub> sensors in frame and keel*

### **SeaFET pH sensors**

SeaFET deployment on the buoy and sensor frame - SeaFET SN 105 was deployed on the buoy and SeaFET SN 111 was deployed on the sensor frame at 30 m. The buoy mounted SeaFET is powered via an OceanSonics BP3 battery pack (S/N 2306) configured for 14.4 V and 200 Ah. It is connected to the Telemetry Hub via cable harness 'BuoypH'. The sensor frame SeaFET is powered via a Satlantic 102 Ah battery pack (S/N 444) and is connected to the sensor frame Datahub via cable harness 'D'.

On the frame, the SeaFET was set up to sample in periodic mode with a sampling interval of 30 min and 1380 sec offset (23 min past the hour), producing 3 Frames per burst (output of 3 samples, each is an average of 10 readings) and creating a DAILY log ASCII file. On the buoy, the SeaFET was set up to sample in PERIODIC mode with a sampling interval of 30 min and 1620 sec offset (27 min past the hour), producing 3 Frames per burst (output of 3 samples, each is an average of 10 readings) and creating a DAILY log ASCII file. Note that the sampling regimes cannot be changed remotely.

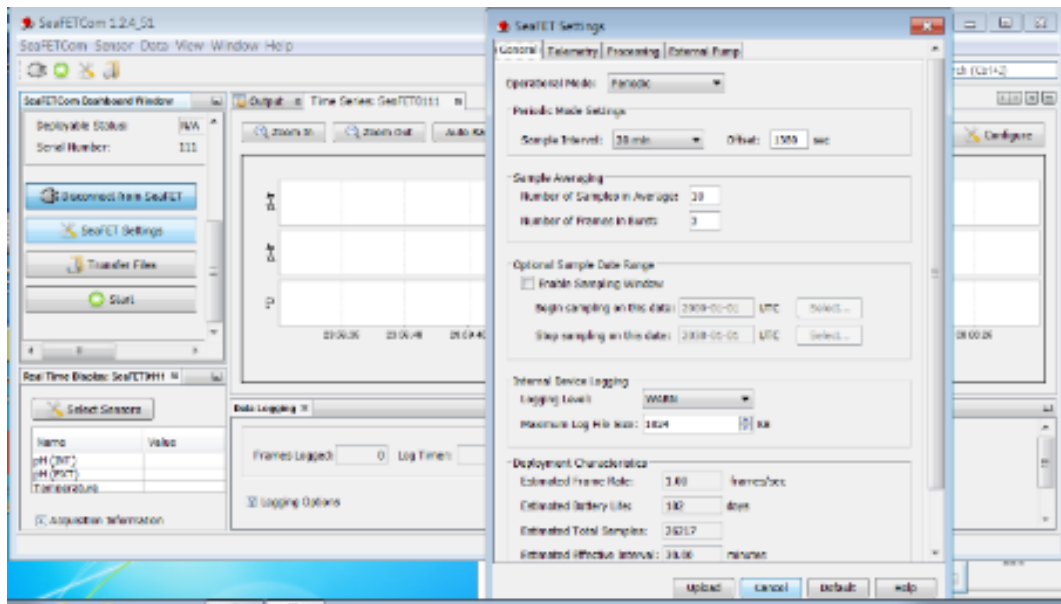

*SeaFET 111 pH sensor configuration for the deployments on the frame*



*Photo of SeaFET 111 pH sensor on the frame*

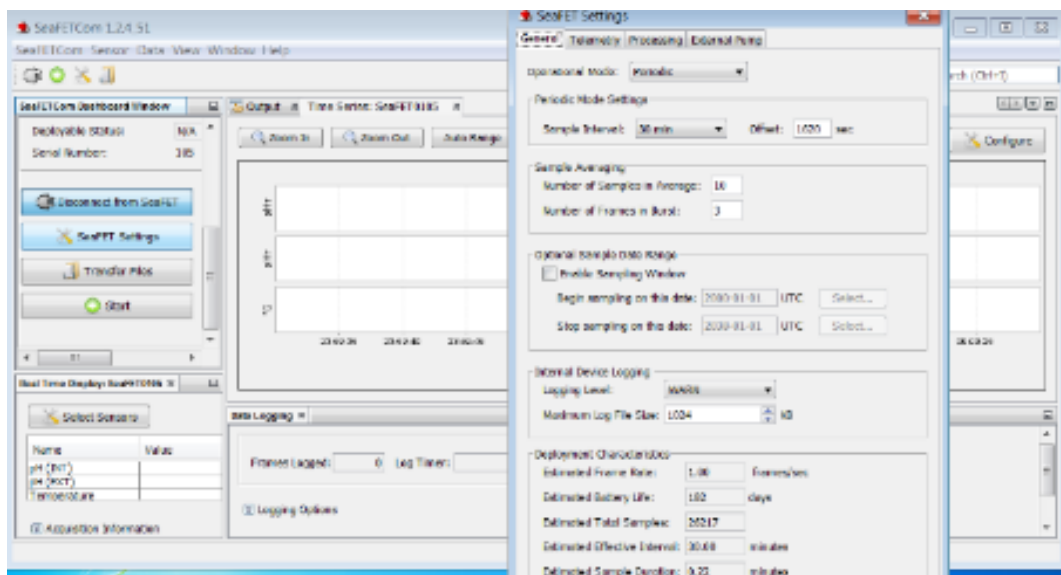

*SeaFET 63 pH sensor configuration for the deployments on the buoy*



*SeaFET SN105 on the keel JC165*

The two SeaFETs that were deployed (s/n 105 and 111) have small internal battery packs that are sufficient to power the sensors for a month or two if the main power supply fails. These were connected the day before deployment and the copper biofouling guards were put in place. Note that the newer SeaFETs, such as s/n 257 which was recovered, have two internal batteries, one of which provides an uninterrupted and isolated source of power to keep the sensing element conditioned.

SeaFET pre-deployment calibrations for deployment on a sensor frame and buoy - Both of the JC165 SeaFET instruments were calibrated by Seabird on the 13<sup>th</sup> April 2018. The results for SN111 (to deploy on the frame) showed high internal and external pH offsets (2.086 and 8.586 respectively), consistent with high readings at the end of DY077. These were adjusted to 0.315 and 0.341 at the Seabird calibration. SeaFET SN105 (to be deployed on the buoy), showed low internal and external pH offsets (0.002 and 0.002 respectively). The calibration certificate after ISFET replacement stated an offset of 0.1715 and 0.1747 for the internal and external pH of SN 105.

The laboratory calibration of SeaFET pH sensors (SN 105 and 111) summarised below was done on board the RRS *James Cook* on 20<sup>th</sup> May 2018. A Certified Reference Material (CRM, from Andrew Dickson, Scripps) from batch 140 was used. Taking the values from the CRM certificates, the measured temperature of the CRM (18.3 °C) and CO2sys (v2.1) the calibrant pH was calculated as 7.955. The SeaFET sensors were switched on for 1 hour then the cell of each of the SeaFETS was rinsed and filled with the CRM. The ISFET temperature (measured by the SeaFETS) continued to rise over the next 2 hours (the response is slow as the sensors are within the gel of the ISFET). When the temperature had stabilised the range of pH readings were recorded for the internal and external electrode. The ISFET thermistor is not calibrated and differed to the measured temperature (as shown in the table). The results are all tabulated below.

The slope and offset for each SeaFET at the seabird cal lab are summarised in the table below along with results from the JC165 laboratory calibration.

Manufacturer's and in lab calibrations of the SeaFET sensors to deploy on JC165.

	SN105	SN111
<u>SeaFET cal at Seabird: 13/4/18</u>		
Received INT	0.002	2.086
EXT	0.002	8.586
After cal INT	0.1715	0.315
EXT	0.1747	0.341
Slope INT	-1.1012 E-3	-1.1012 E-3
Offset INT	-8.219 E-02	-8.524 E-02
Slope EXT	-1.048 E-03	-1.048 E-03
Offset EXT	-1.0555	-1.2145
<u>On- board cal 20/5/18</u>		
Instrument temp (at 18.3 degC)	19.15	18.79
pH range INT for 7.955	7.85-7.87	7.825-7.875
pH range EXT for 7.955	7.9-7.925	7.875-7.950

In summary, taking a comparison of the average pH and the pH of the CRM into account the following approximate factors could be applied to the SeaFET sensors. This may be reviewed at a later date.

SN INT or EXT	By this factor
105 INT	1.0121
105 EXT	1.0054
111 INT	1.0134
111 EXT	1.0054

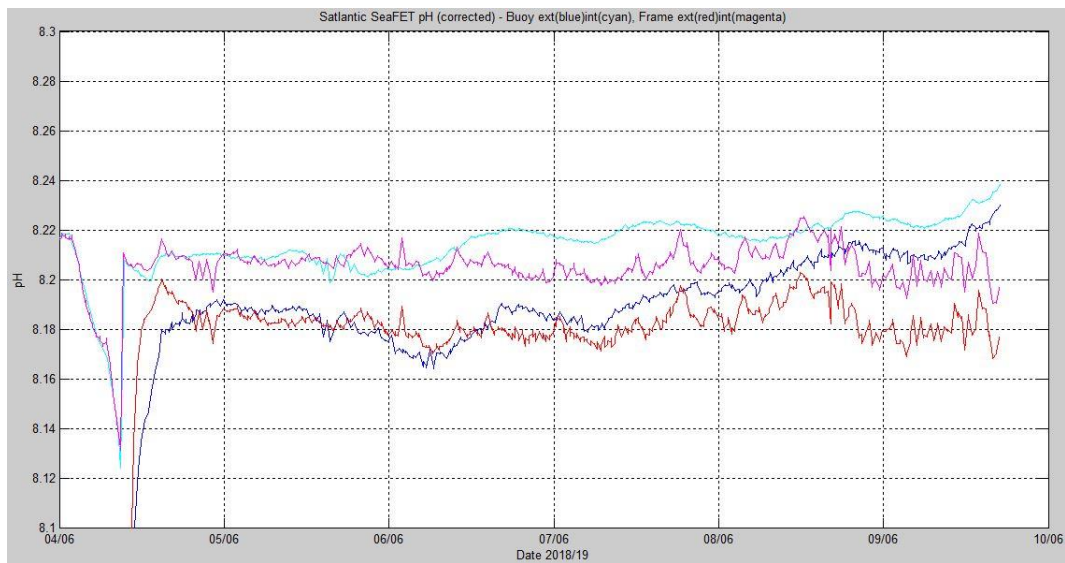

## Cycle Phosphate for Deployment

Hydro cycle phosphate sensor s/n 458 - The hydrocycle was checked at NOC, but there was not time to bench calibrate before the cruise. The hydrocycle was set up to calibrate against 4 concentrations of phosphate standard and 100% MQ. Instrument s/n 458 was connected to laptop via star tech converter, baud rate 19200. New reagents were primed as per quick start. The dilutions were made from 100  $\mu\text{M}$  phosphate standard and were 2.0, 1.0, 0.5, 0.3 and MQ. First standard (2.0  $\mu\text{M}$ ) was flushed using standard flush, but gave readings of only 0.5  $\mu\text{M}$ , so flush repeated. Instrument s/n 458 was run through 4 repeats of 4 concentrations to produce a bench calibration prior to deployment. The graph below gives strong confidence in the accuracy and precision of the instrument. This calibration will be applied to any recovered data.

### Hydro cycle 458 bench cal (JC165)

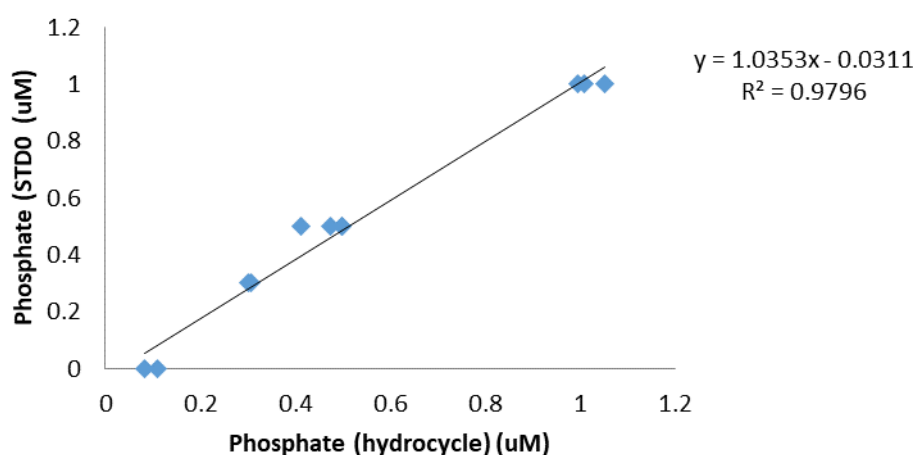

Prior to Hub test, sample tube was connected, the case replaced, reagents were changed over to deployment packs, 100 pumps per reagent to run through. Then the instrument was placed in a bucket of water to be tested on the hub, where it communicated but the string of numbers did not produce a sensible number from the hub. It was suspected that the text outputs had changed when the hydrocycle was updated from the cycle. Jon Campbell reworked the scripts for the hub to recognise this and the hydrocycle was reprogrammed for another trial which was successful.

The hydrocycle was set up for deployment on 03/06/18 allowed to prime in a bucket of MQ then fixed onto the frame with a first sample set for 04/06/18 18:20 and then every four hours. The hydrocycle was transmitting sensible numbers as of 06/06/18. **Notes for 2019:** Bring tubing for input and output, 200 ml volumetric flasks ( $\times 4$ ) 5 ml pipette, syringe for flushing and priming, phosphate standard, collection bottle for output, tray to stand all in. The Hydrocycle is powered by an Ocean sonics 228 Ah battery.

## Satlantic OCR-507 Irradiance sensors

A Satlantic OCR-507 ICSA irradiance sensor (SN 201) was fitted to the buoy mast and is controlled by the Telemetry Unit. The Data Hub controls an OCR-507 ICSW upward-looking irradiance sensor (SN 200) and an OCR-507 R10W downward-looking radiance sensor (SN 113).



*Satlantic radiometers pre-deployment on the buoy, upward and downward looking on the frame. Note the plastic screws on the buoy copper shutter, the others now have metal screws.*

All 3 sensors were setup to sample every 30 minutes at the same time so that their data are coincident. The sampling intervals can be changed remotely using SBD commands. The buoy mast mounted OCR is powered via the Telemetry hub and is connected to the Telemetry hub via cable harness 'BuoyOC3'. The sensor frame mounted OCRs are powered via the Data Hub and connect to the Datahub via cable harness 'D'.

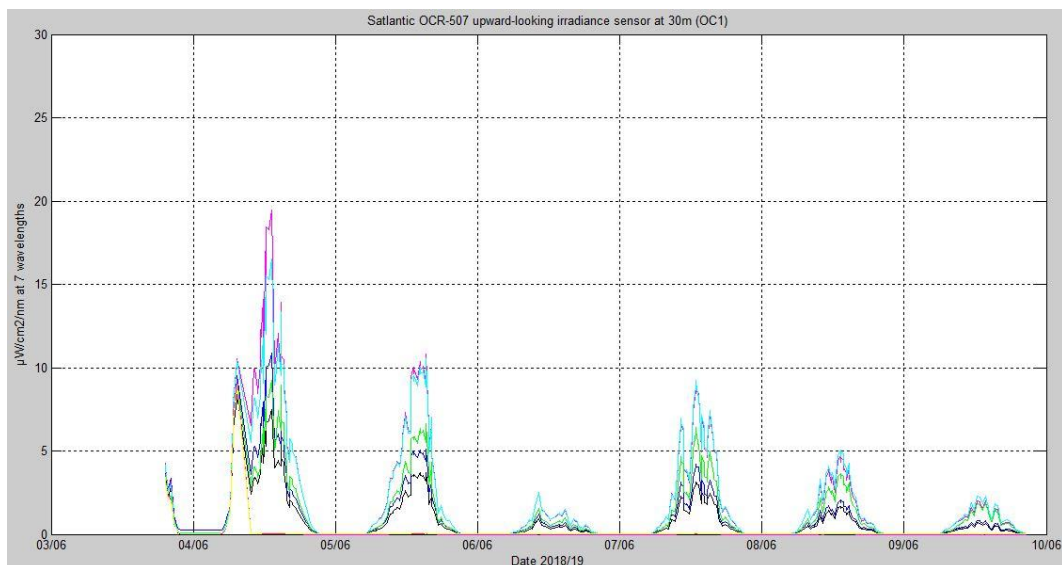

*Data from the OCR 1 radiometer after deployment.*



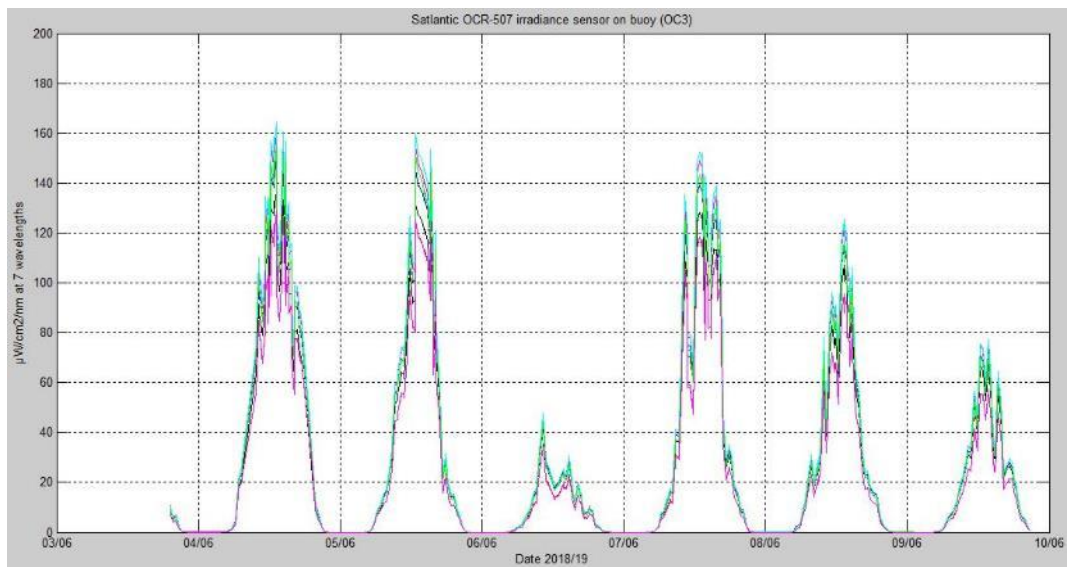
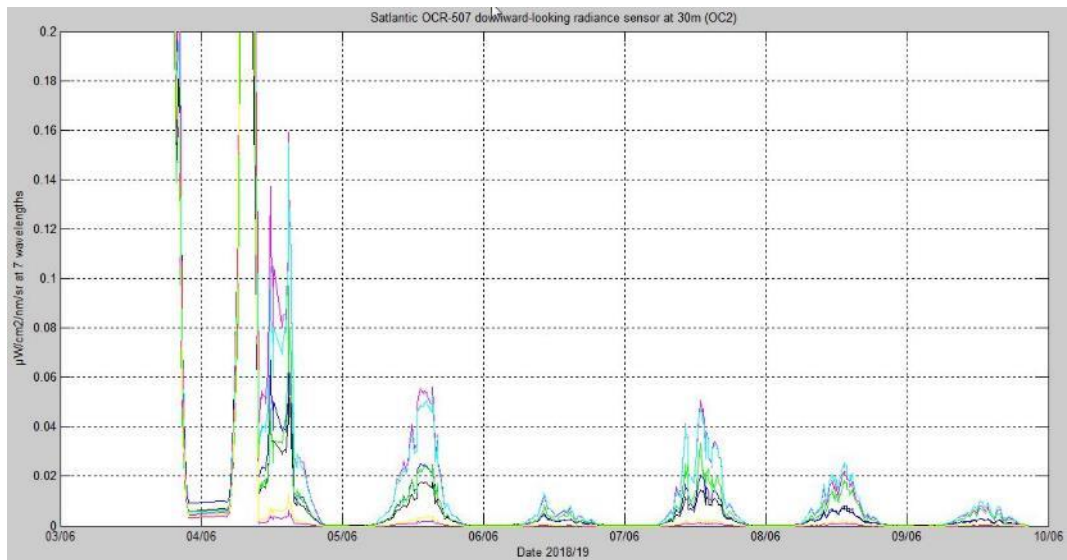

*Data from the OCR 2 and 3 radiometers after deployment*



## Star-oddi pre-deployment calibration on a CTD frame

Star oddis able to go on the CTD to 100m depth were calibrated. The data will be worked up at NOC.

Deployment at depth - Star ODDIs were deployed at PAP#1 below the buoy and frame, as well as on the frame (where there is a star ODDI plus tilt sensor). The deployment summary is given in the table below.

*Star ODDI sensors below the buoy (all type DST-centi)  
and on a sensor frame at 30 m depth (type DST-tilt).*

Serial No.	Type	Depth (m)	Position	Interval	Deploy date	Deploy time	Battery remaining	Max depth (m)	JC165 Calibration
S7728	DST CTD	0	Buoy	10 min	6/4/2018	9:07:00	43%	100	Yes
S6784	DST CTD	0	Buoy	10 min	6/4/2018	9:07:00	42%	100	Yes
C8928	DST CENTI	5	Chain	10 min	6/4/2018	9:07:00	86%	100	Yes
C8929	DST CENTI	10	Chain	10 min	6/4/2018	9:07:00	86%	200	Yes
C8930	DST CENTI	15	Chain	10 min	6/4/2018	9:07:00	86%	100	Yes
C8984	DST CENTI	20	Chain	10 min	6/4/2018	9:07:00	87%	500	Yes
H0833	DST TILT	30	Frame	10 min	6/4/2018	9:07:00	78%	500	Yes
S7727	DST CTD	30	Frame	10 min	6/4/2018	9:07:00	46%	300	No
C8994	DST CENTI	75	Below frame	10 min	6/4/2018	9:07:00	88%	500	No
C8990	DST CENTI	100	Below frame	10 min	6/4/2018	9:07:00	88%	500	No
S6788	DST CTD	150	Below frame	10 min	6/4/2018	9:07:00	41%	2049	No
C8991	DST CENTI	250	Below frame	10 min	6/4/2018	9:07:00	88%	500	No
C8967	DST CENTI	350	Below frame	10 min	6/4/2018	9:07:00	88%	3000	Yes
C8969	DST CENTI	450	Below frame	10 min	6/4/2018	9:07:00	88%	3000	Yes
H0786	DST TILT	1000	Below frame	10 min	6/4/2018	9:07:00	87%	2000	Yes
S6789	DST CTD	1000	Below frame	10 min	6/4/2018	9:07:00	43%	2047	No

## PAP1 Recovered Data Hub and Telemetry Systems



*Recovered frame showing biofouling and the frame and sensors*

*Longevity of Sensors on Buoy, 30m Frame and Chain; Data return and assessment needs for recovered sensors at the frame*

Sensor	Performance	Recommendations and Actions
SeaBird SBE-37IMP MicroCAT 9030	No data. It appears unit was not configured to record and inductive telemetry was inoperative because of a damaged coupler	To service
SeaBird SBE-37IMP MicroCAT 10535	1 year of data. Low power on retrieval	To service
SeaBird SBE-37IMP MicroCAT 13397	Flooded, 4 months of data had been transferred to and stored on buoy Telemetry Unit	To replace
WETLabs FLNTUSB Fluorometer 3050	Clean copper & Full data	To service
Satlantic SUNA Nitrate sensor 745	Only 1 month of data as power supply from battery pack seems to have failed.	To service. Needs more copper.
Satlantic SeaFET pH sensor 63	Full data	To service
Satlantic SeaFET pH sensor 257	Unit recorded data intermittently. 2 intermediate months missing	To service
Aanderaa 4430H Seaguard 1614	Full data	To service. Need 4 non Li batt. packs
Satlantic OCR-507 ICSA irradiance SN 226 on buoy - with Bioshutter	Full dataset recorded by telemetry unit. Copper guard had been bent vertical	To service
Satlantic OCR-507 ICSW irradiance SN 287 with Bioshutter	38 days of data recorded by data hub. Lost, probably knocked off frame by load cell	To replace
Satlantic OCR-507 R10W radiance SN 95 with bioshutter	37 days of data recorded by data hub. Copper shutter missing	To service
Pro-Oceanus CO2-Pro 29-097- 45 buoy	Full data recorded in telemetry unit	To service
Pro-Oceanus CO2-Pro 33-200- 45 Frame	7 months of data	To service
Pro-Oceanus GTD-Pro	6.5 months of data	Replace with mini GTD next year

WETLabs CYCL-P Phosphate Analyser 164	No data (damaged 3 places on the power cable and the connectors)	To service/ upgrade
---------------------------------------	--	---------------------

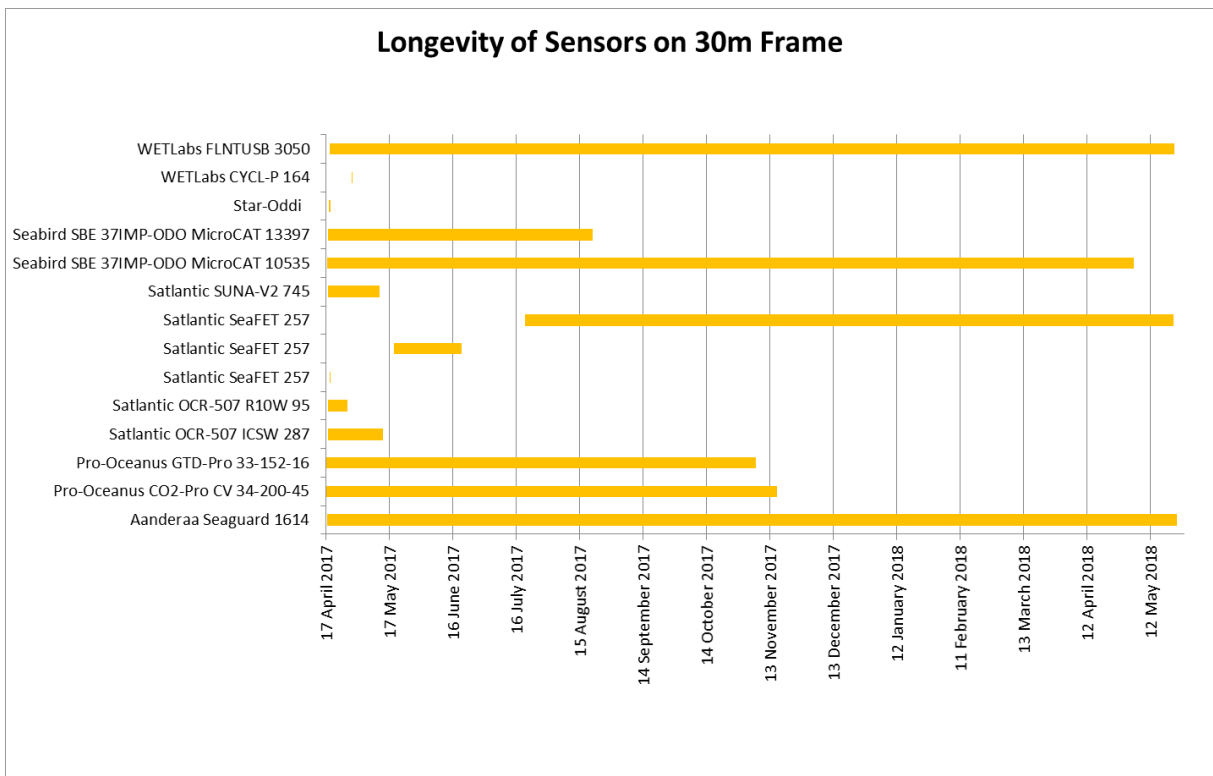
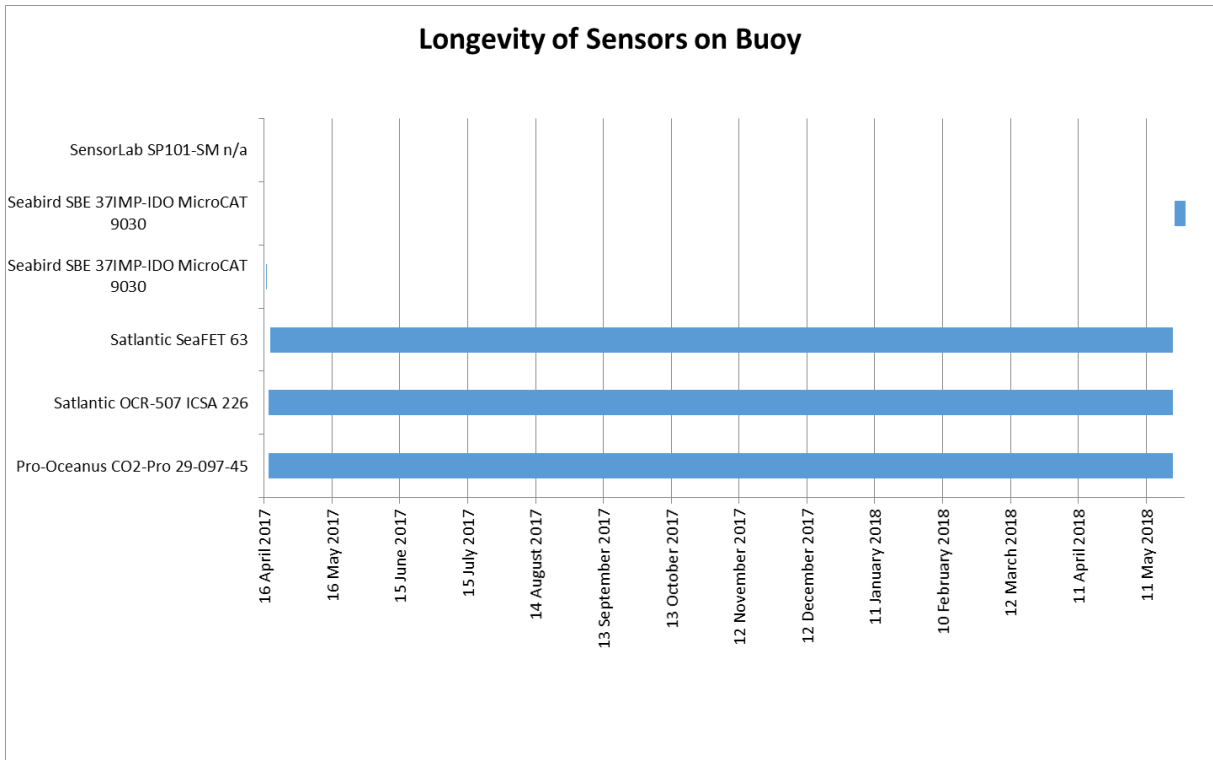

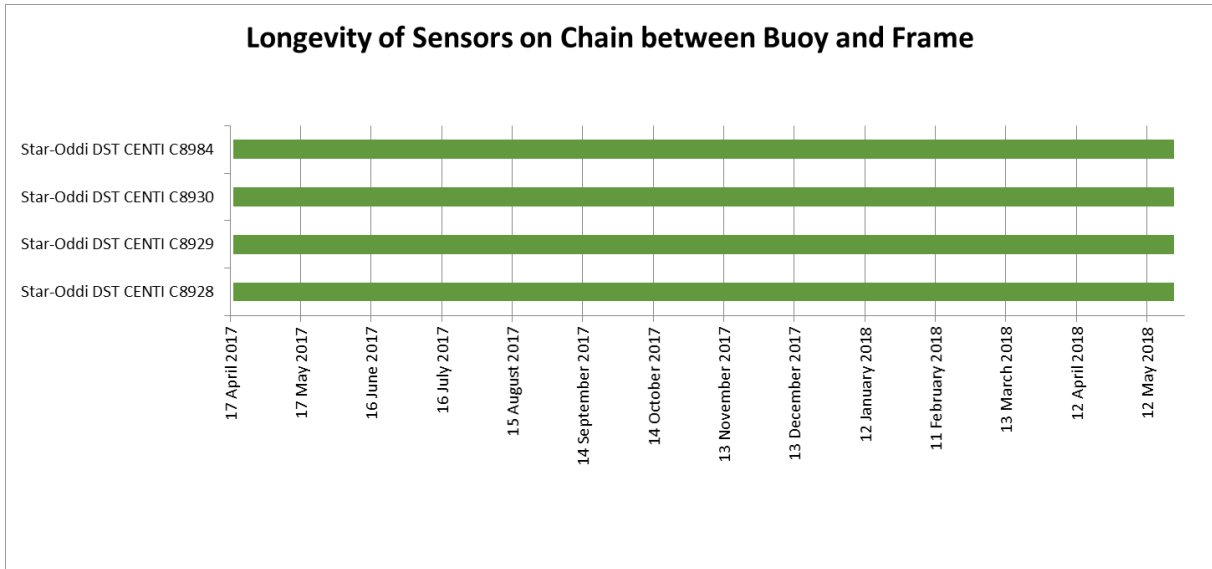

On RRS *Discovery* cruise DY077 we incorporated some new stand-alone sensors in the frame. They were not connected to the data hub and logged data internally. The OTEG Conductivity and Temperature sensor will be returned to NOC for assessment after JC165. The OTE Lab on a Chip Nitrate sensor has been damaged (mesh around the reagent housing missing, reagent bags no longer present in the housing and electrical connector to external battery disconnected) meaning external communications are no longer functioning, data retrieval from this sensor will be investigated at NOC and there were also load cell issues. All of these will be looked into in more detail at NOC.

### Recovery of the Seaguard

*PAP 1 recovered on 23/05/18 Seaguard initially looked intact.*

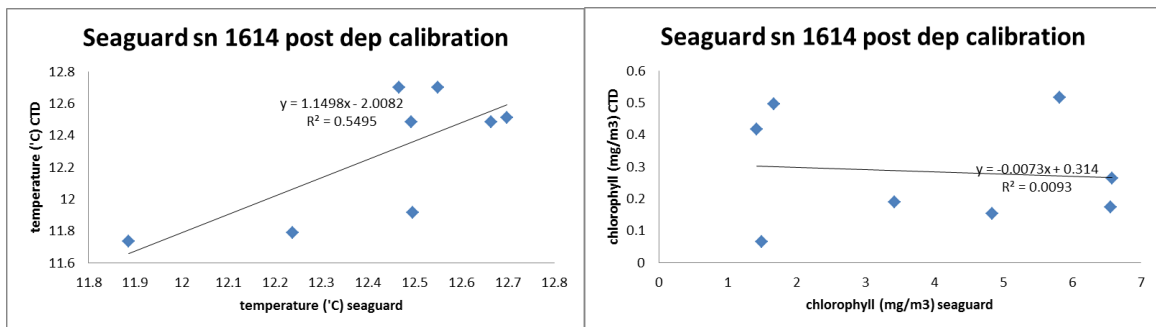

The data downloaded successfully and the instrument was calibrated on CTD07 (JC165-23). The post deployment calibration was poor (for more details of chlorophyll extraction please see section on wetlabs fluorometer deployment). The timings were checked and lined up correctly, but both the temperature and chlorophyll were low  $R^2$  so perhaps the instrument has drifted a lot after a year's deployment.

The correction is chlorophyll (mg/m3) = seaguard  $\times$  0.0073 + 0.314 ( $R^2 = 0.009$ )

The temperature correction is Temperature = seaguard  $\times$  1.0198 - 2.0082 ( $R^2 = 0.5495$ )

The calibrations applied to the data produce the graphs below. At NOC further investigation into the recovered data may improve the calibrations but this data is unusable without better corrections.

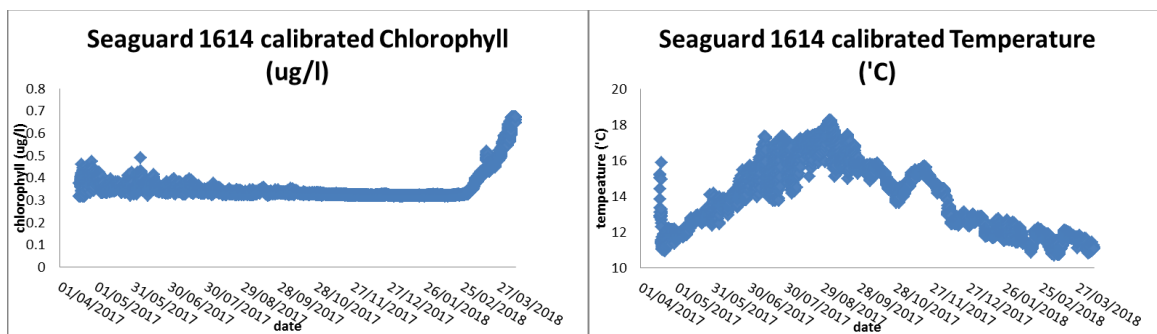

*Callibrated chlorophyll and temperature.*

### **Pro-Oceanus sensors**

We received data from the buoy Pro-CO<sub>2</sub> sensor (SN 29-097-45) throughout the year. The system reached equilibrium easily early on, but the samples did not look fully equilibrated towards the end of the deployment. This will need to be looked at in more detail – it may be a fault in the sensor or fouling in the pump. However, both pumps were still working after they were recovered (though this was after cleaning).

The CO<sub>2</sub>-Pro sensor on the frame (SN 33-200-45) stopped giving sensible data towards the end of October. As can be seen in the plot below the CO<sub>2</sub> readings plummeted at this time and then the sensor stopped working (we could not connect to it after recovery of the sensor). The sensor does not appear to be flooded and will need to go back to Pro-Oceanus to be assessed as well as recalibrated.

The GTD-Pro sensor on the frame (SN 33-152-16) stopped logging in November and would not communicate after recovery, although the housing has not leaked.

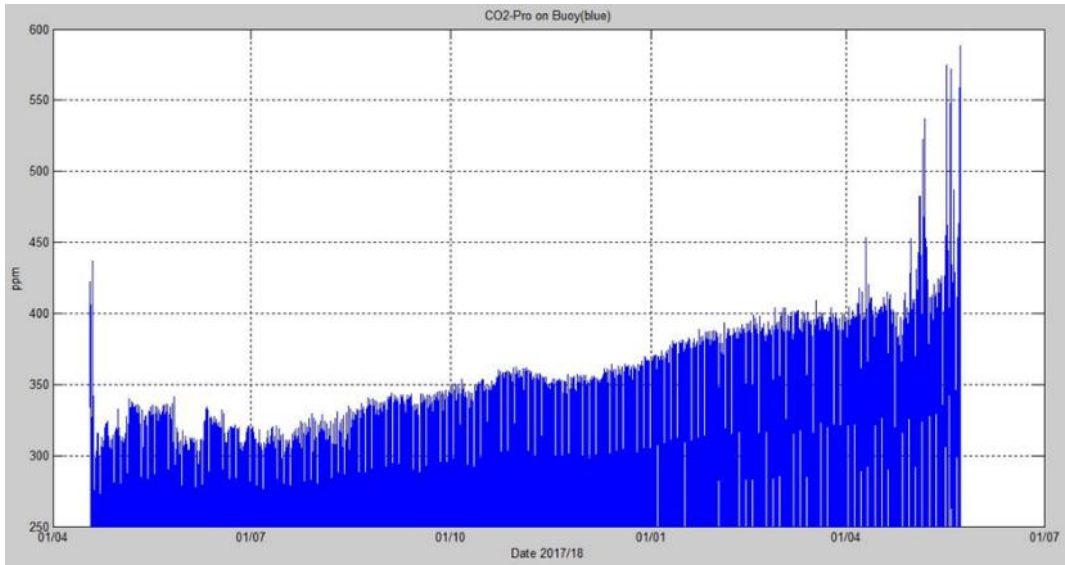

*pCO<sub>2</sub> data from the buoy (SN 29-097-45)*

CO<sub>2</sub> data 2017-2018 frame

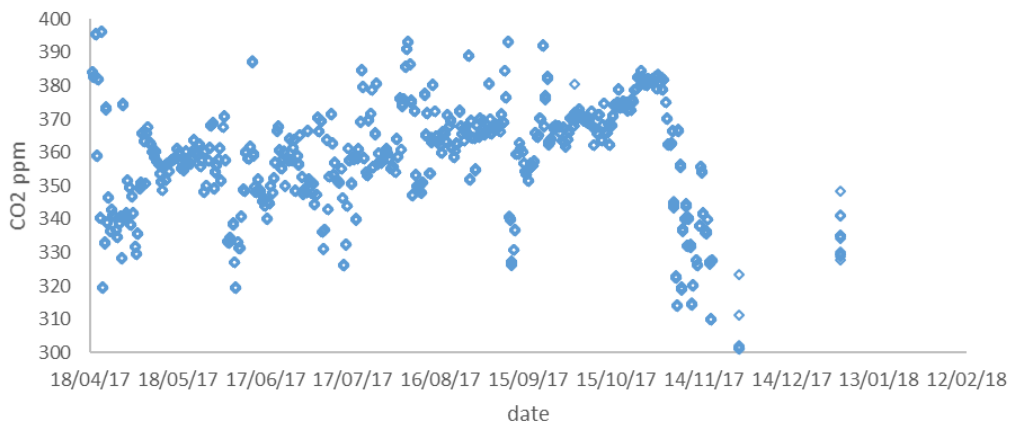

*pCO<sub>2</sub> data from the frame (SN 33-200-45)*

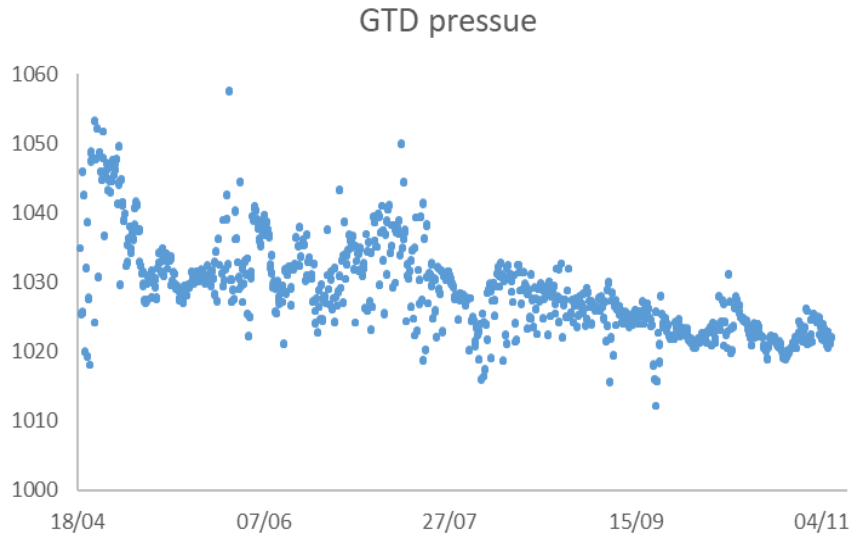

*Pro-GTD pressure data 2017-2018*

**Sea-Bird SBE 37 MicroCATs**

Three MicroCATs were recovered from the 2017-2018 deployment. Two of the Sea-Bird SBE 37-ODO (SN 10315 and 13397) were attached to the frame on DY077 and set to sample temperature, pressure, conductivity and oxygen concentration every 30 minutes. SBE 37-IDO SN 9030 had been clamped onto the keel but appears not to have been configured to sample. It also had a damaged inductive coupler meaning that it could not be interrogated by the telemetry unit. On recovery the newest SBE microcat (SN 13397) was found to have flooded and SN 10535 had a low battery (recording data to the 4<sup>th</sup> May 2018).

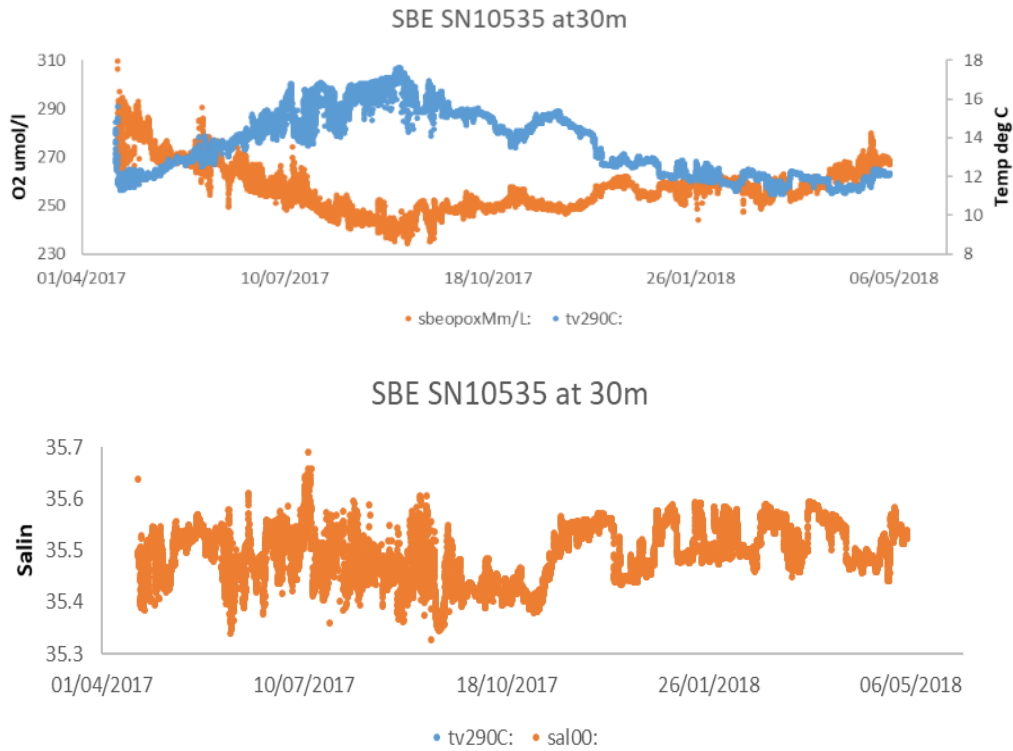

*Post deployment microcat data (uncalibrated) from the SN 10535 SBE at 30 m on the frame*

### **Satlantic OCR-507 Irradiance sensors**

Three OCR sensors were deployed last year on DY077; all were serviced before the deployment and they are paired with a bioshutter to reduce biofouling. Two were recovered: the Satlantic OCR-507 ICSA irradiance sensor (SN 226) fitted to the buoy mast and the OCR-507 R10W downward-looking radiance sensor (SN 95) on the frame. The OCR-507 ICSW upward-looking irradiance sensor (SN 287) was missing from the frame. The bioshutter had been bent out of position on the buoy (SN 226) and was vertical on recovery.



## Wetlabs fluorometer

The fluorometer s/n 3050 looked operational on the frame and the shutter was showing good anti-fouling. It was recovered and washed in warm fresh water. The data was downloaded, and the factory calibrations applied:



Wetlabs fluorometer



Factory calibrations:

Thermistor calibration:  $\text{temperature} = (\text{output} \times \text{slope}) + \text{intercept}$

Where slope =  $-0.0056 \text{ }^\circ\text{C}/\text{count}$  and intercept =  $71.2536 \text{ }^\circ\text{C}$

Pressure sensor calibration:  $\text{pressure} = (\text{output} \times \text{slope}) + \text{intercept}$

Where slope =  $0.034 \text{ dBar}/\text{count}$  and intercept =  $-2.74 \text{ dBar}$

Chlorophyll Scale Factor:  $\text{Chl}(\mu\text{g}/\text{l}) = \text{Scale Factor} \times (\text{output} - \text{dark counts})$

Where scale factor =  $0.0072 \mu\text{g}/\text{l}/\text{V}$  and dark counts = 47 counts

Nephelometric Turbidity Unit (NTU) Scale Factor =  $\text{Scale Factor} \times (\text{output} - \text{dark counts})$ .

Where scale factor =  $0.0025 \text{ NTU}/\text{V}$  and dark counts = 49 counts

The fluorometer had lost 2 minutes over the 15 month deployment.

### calibration wetlabs sn3050 post dep cal

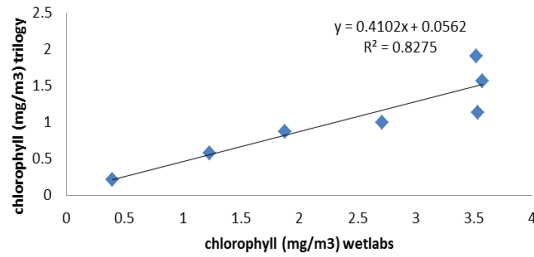

The data downloaded easily for the year and the instrument was reprogrammed for the post deployment calibration on CTD JC165\_12. Data were downloaded for calibrations. Wetlabs sn 3050 was put on CTD05 (JC165-12) to calibrate chlorophyll data.

Post deployment calibration factor: Chlorophyll =  $0.4102 \times$  wetlabs output + 0.0562

### chlorophyll 2017/18

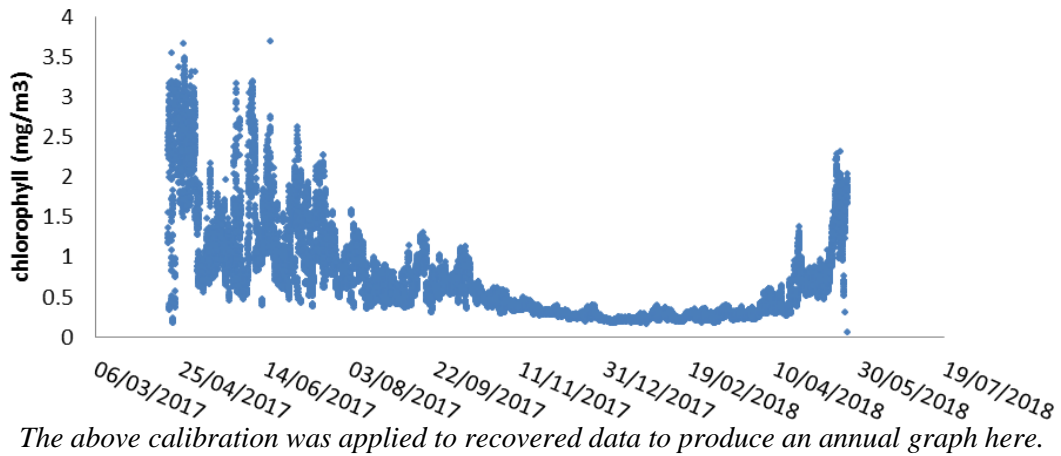

*The above calibration was applied to recovered data to produce an annual graph here.*

### Cycle P phosphate sensor

The Cycle P did not communicate with the hub after deployment on DY077 so it was not known whether it had worked or not over the last year. When it was recovered there was damage both to the cables and the handles on the instrument. It was difficult to remove from the frame and was thought to have been hit by another object perhaps the load cell.

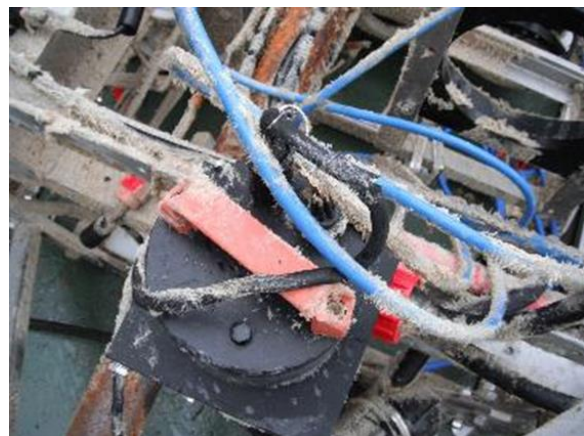

*Cycle Phosphate Sensor recovered*

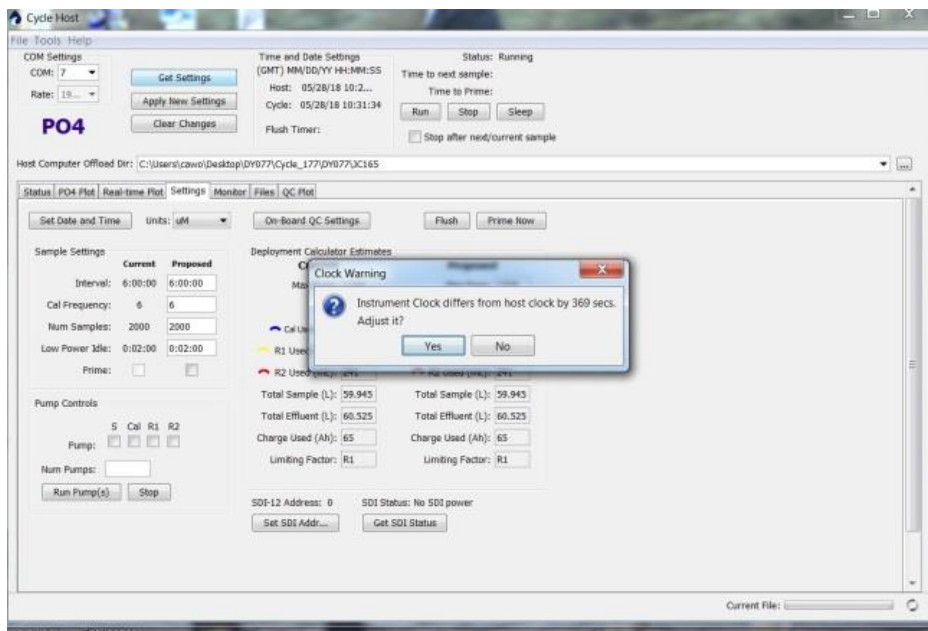

On recovery the instrument switched on as soon as power was supplied, the clock was significantly adrift. The saved files were downloaded. It appears that the sensor had only sampled twice – the third sample was when it was powered up to download data.

Date	Time	Run	CAPO4 (µM)	VAPO4 (µM)	VAS	State	Flush1	Amb Min	Flush2	Cal Min	Re maining	DIAG 1	DIAG 2
04/29/17	00:00:01	8	nan	nan	0	0	0	0	0	0	2000	48	1
04/29/17	06:00:02	9	nan	nan	0	0	0	0	0	0	2000	48	1
05/28/18	10:30:17	10	-3.124	2.668	-5.046	9	7.8	14	34	84	1999	48	1

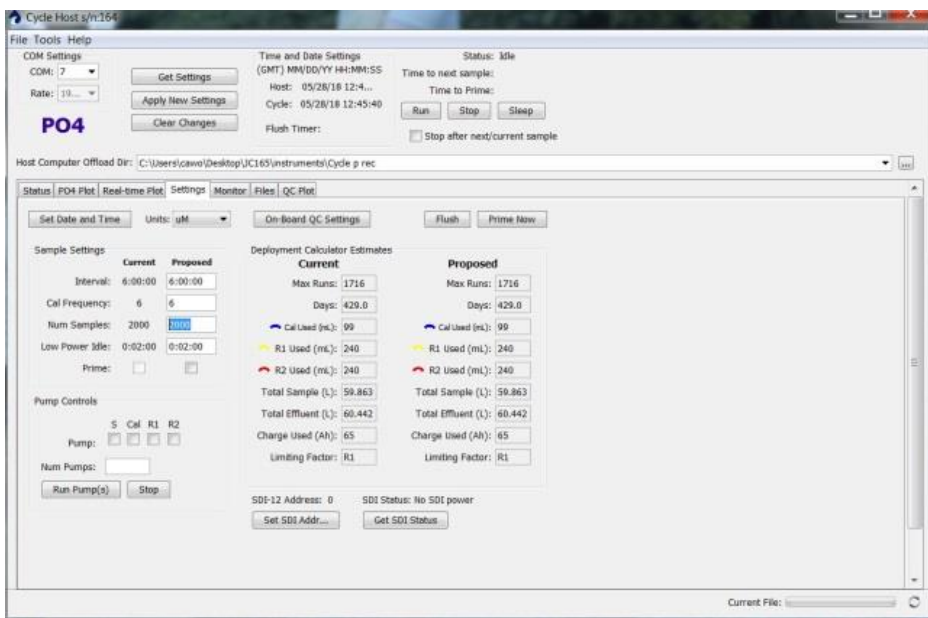

The settings files were interrogated: they showed that the cycle-p was set to autonomous operation which was why it had not communicated with the hub. But the sampling programme appeared to be

OK. To check, the settings were replicated on the bench using the old chemicals and though the values were not useful the operation appeared to work correctly. It was surmised that the damaged cable had interrupted power supply and that it may have happened soon after deployment.

### Satlantic SUNA Nitrate Sensor recovery and calibration

SUNA (SN 745) deployed on a sensor frame during cruise DY077 was successfully recovered on JC165. Calibration checks on the SUNA 745 (post deployment) were done in DIW (24/5/18) and gave a reading of -1.8 (that changed to 2.7 after cleaning). The 5 and 10  $\mu\text{M}$  standards gave readings of 5.3 and 7.97  $\mu\text{M}$  respectively (the standards were made up at NOC and stored in the fridge, following the calibration check they were frozen and will be analysed on the Quattro auto-analyser back at NOC). Prior to this the approximate post suna calibration can be estimated as follows:  
 Nitrate ( $\mu\text{mol/l}$ ) =  $0.4944 \times \text{suna} + 2.7289$



*SUNA post deployment under heavy fouling, and the unit cleaned and set up for calibration*

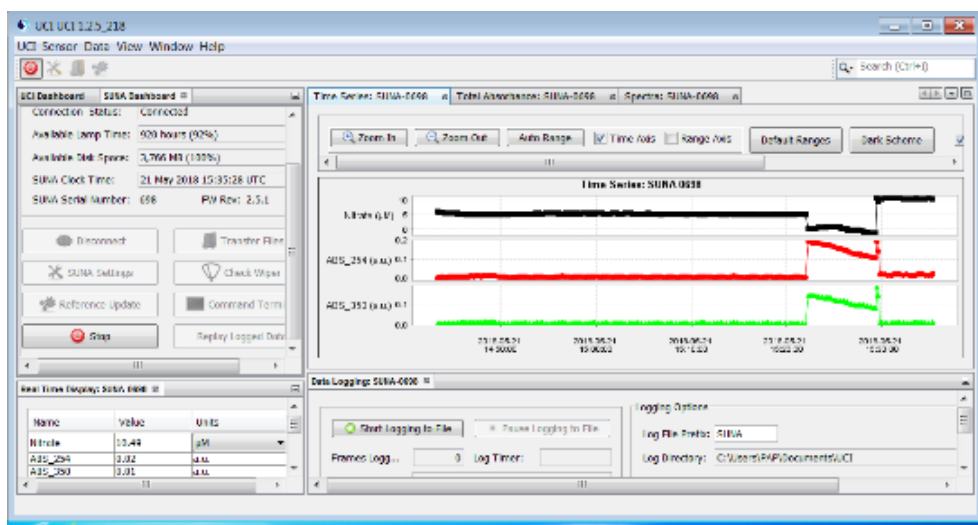

Although the instrument was still working on recovery it had stopped recording any data about a month after deployment. The instrument was heavily fouled on recovery but this was unlikely to have happened after just a month. Prior to the instrument stopping (on the 15<sup>th</sup> May) there were periods of data dropout eg: 4<sup>th</sup> May 2017. There were some erroneous high nitrate readings recorded on the 19<sup>th</sup> April (~14-48  $\mu\text{mol/l}$ ) that have been excluded from the figure below. Internal log files recorded by the SUNA suggest that its external power supply failed after a month, probably caused by a faulty cable harness in the sensor frame.

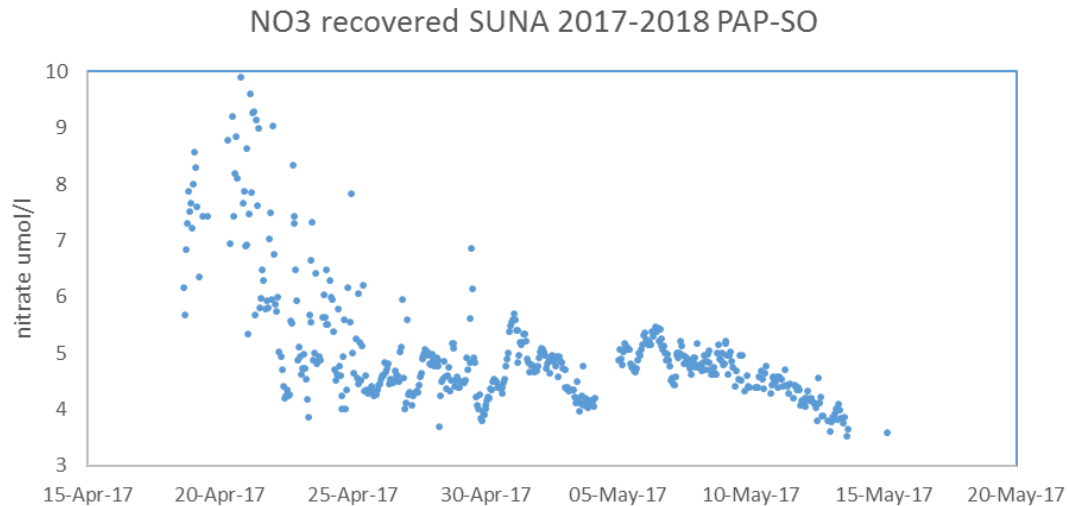

*Uncalibrated Nitrate from Atlantic SUNA SN 745 from the sensor frame*

Overall, SUNA collected Nitrate concentration data from day 108 to day 135. There were also some intermittent lines of data on days 249, 267-269, 276, 278 and 280. We will investigate this with the manufacturer. We still need to apply a calibration to the data when the nutrient concentrations are measured at NOC. The software also takes account of the interference by bromide and salinity (this requires the cal and xml files to be applied to the data).

### **pH SensLab sensors**

Sensor Lab SP101-Sm pH sensor was recovered on JC165. It was on loan from Melchor González Dávila at ULPGC on Gran Canaria. The SP101 was calibrated before being received by NOC and checked and serviced in Southampton before the DY077 cruise began (by Melchor). However, there were a lot of failures in the sensor during the tests at NOC and on board DY077. After deployment, it appeared to have flooded over the year and was not redeployed.





*Photo showing the extent of flood damage on the inside of the pH Sensorlab*

### **Satlantic SeaFET pH recovery and calibration**

On DY077 the SeaFET pH sensors SN 63 (buoy) and SN 257 (frame) were deployed on the 18<sup>th</sup> April 2017 (day 108). They were programmed to take samples every 30 min. On the frame, the SeaFET 257 was connected to an Ocean Sonics battery with 206 Ah and on the buoy SeaFET 63 was also powered by an OceanSonics battery on the keel with 206 Ah (one of the old set that was recovered in 2016). The SeaFETs were successfully recovered on JC165 (day 142, 22<sup>nd</sup> May). Both were still working and recording data. SN257 had initially failed on Day 108 2017, but then recovered again on day 138 (2017). There was a further data dropout for this instrument.



*Extent of SeaFET fouling (Left) SN 257 on the frame, and (Right) SN63 on the buoy*



*SeaFET copper guards (left as new, extensive damage to the copper on SN257 and on SN63)*

On the Buoy, there was no damage to the copper cover and little visible growth on the SeaFET measurements windows (see photos below) – just a relatively thin layer of biofilm. However, SN 257 had extensive biofouling as the copper cover had degraded. Due to damage of the copper guard, there was growth on the electrodes.



*Extent of SeaFET fouling (Left) SN257 frame and (Right) SN63 buoy*

The electrodes were then left in Low nutrient seawater (LNSW) for a few hours before the calibration checks. The performance of the SeaFETs SN 257 (Frame) and SN 63 (Buoy) post-recovery was tested using CRM Batch 128. At a salinity of 33.442 and a temperature of 18.3°C the pH of this CRM was 8.029 (Calculated using CO2sys and the DIC, TA and nutrient certificated values). Results of the post validation of the SeaFET sensors (on the 24<sup>th</sup> May) are recorded below.

For CRM at pH 8.029	pH <sub>INT</sub>	pH <sub>EXT</sub>
SN63	7.8925-7.8975	7.9900-7.9950
SN257	7.7-7.9	7.5-7.7

A ratio could be applied so that the readings will approach the calibration values as follows:

- SN63 INT × 1.0169
- SN63 EXT × 1.00457
- SN257 INT × 1.029
- SN257 EXT × 1.056

Note that there was a larger range on SeaFET 257 post-calibration, probably due to the fouling (now cleaned off but this is still a large signal). These sensors will go back to SATLANTIC for calibration and Durafet replacements.

SN257

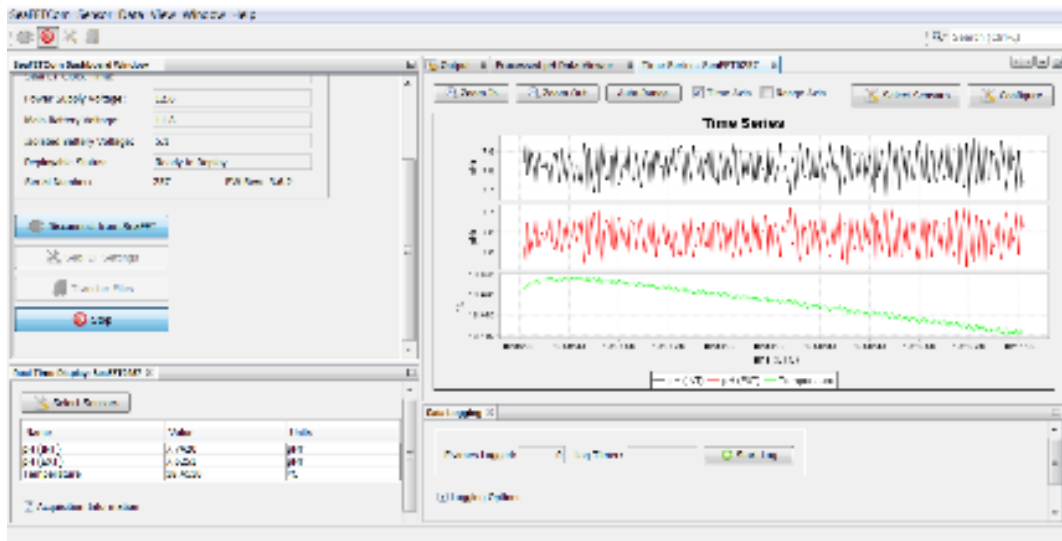



SN63

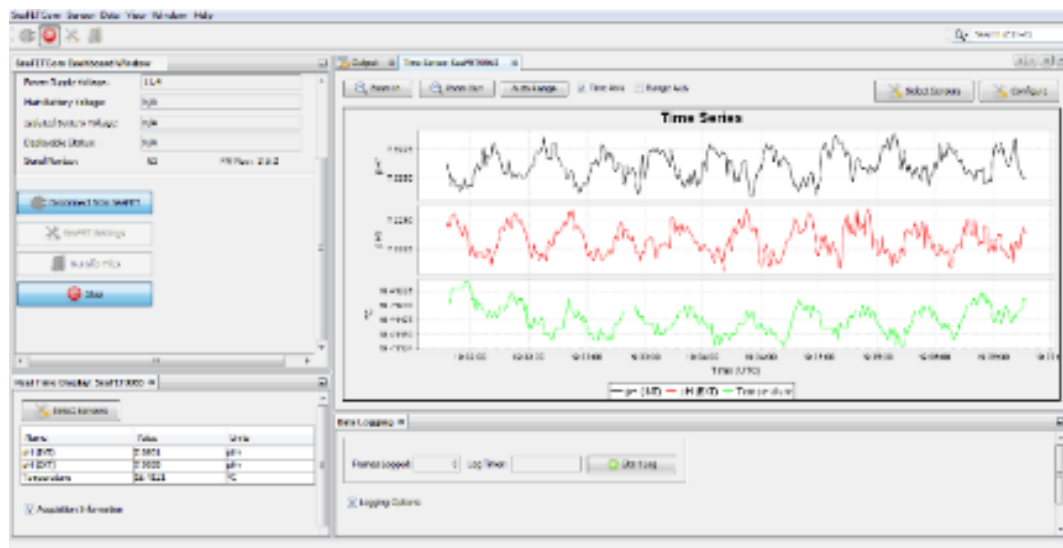

*In lab post recovery calibration checks on the SeaFETs 257 and 63*

The data collected over a year of deployment was successfully downloaded from the internal memory of both instruments. Note that in the new SeaFET data processing package you can merge data files through 'data processing', in SeaFET.com software. At a later date, we can reprocess that data this way (once we have the SBE data). Current selection of 'use header for calibration' and use reference salinity of 35 (as selected) resulted in no change to the data.

The SeaFET 63 recorded continuously from 18.04.2017 although its internal battery was found to be disconnected. However, for SN 257 there were 2 periods of data dropouts, the reason is yet to be identified. The first is a month of missing data from day 109-137 (ie: data recorded initially on day 108 then appeared to stop and restart a month later). SN257 continued to measure to Julian day 171 then data is missing again until day 201. It then continued to record data until recovery (on day 142, 22<sup>nd</sup> May 2018). The internal batteries in 257 were connected.

## SeaFET data recovered – comparison of the 2 seaFETS

Data collected by SeaFET pH sensors SN 257 (red; frame) and SN 63 (blue; buoy) from 18.04.2017 to 2018. No calibration has been applied.

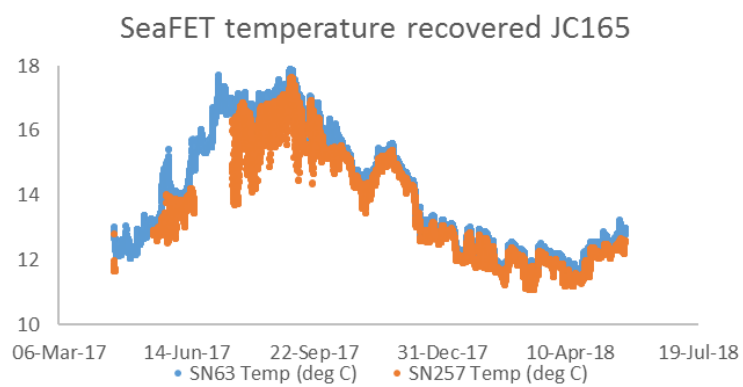
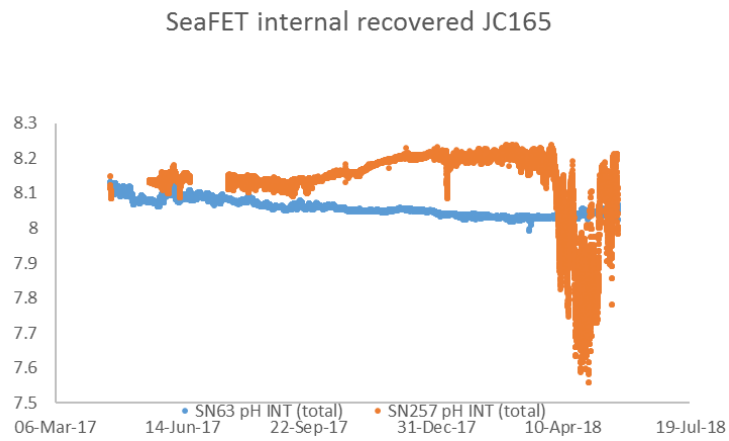
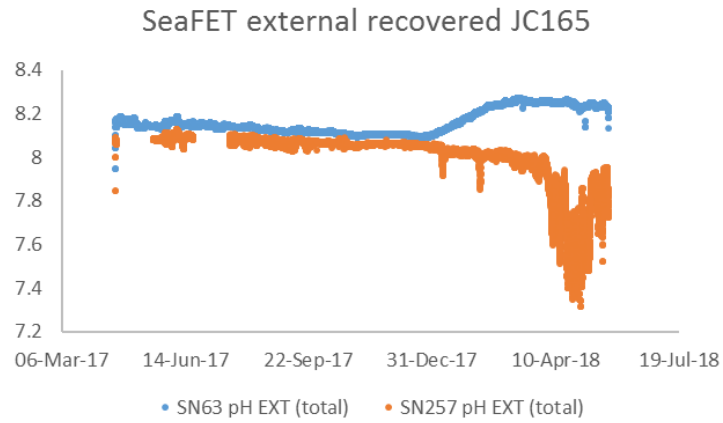

There was good agreement on ISFET temperature between the two sensors, although 257 SN was noisier almost from the start. There was an upward drift in SN63 EXT after 28<sup>th</sup> Dec 2017. Without this data the ranges can be expanded to show more detail (showing a decrease in pH following the spring bloom).

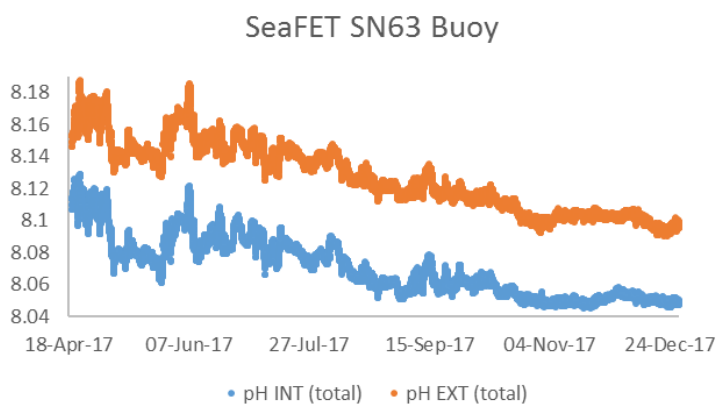

The recovered SeaFET SN 257 (Frame) output shows two data gaps, between day 109-137 and day 172-200. There was also an unexpected decrease in values (INT and EXT) from 2<sup>nd</sup> April 2018. The seasonal pH cycle at 30 m is shown below with the odd data removed:

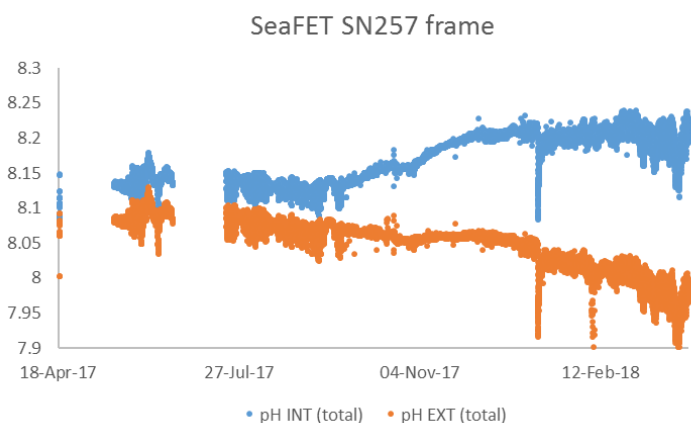

This then highlights an increase in pH INT, and decrease in EXT (from 22<sup>nd</sup> Sept), which is unlikely to be real and needs further investigation. Potentially useful pH data from SN257, shows an increase in pH during the bloom period in June 2017 and shows the two data gaps clearly (see below).

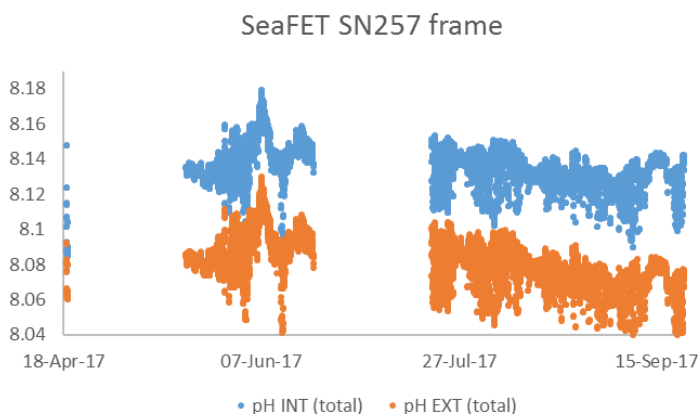



## Star ODDIs Recovery and Deployment at PAP1

Recovery and calibration - Star ODDIs deployed at PAP1 below the buoy, on and below the sensor frame were recovered on JC165. All the Star Oddi systems below the frame were recovered and were still working after 4 years deployment. Star ODDIs were recovered on 23.05.2018 from the buoy and the chain. On 05.06.2018 Star Oddis were recovered from below the frame. Star ODDI H0883 was recovered from the PAP1 frame at 30 m. An unknown fault prevented the recording of temperature and pressure, but tilt data were retrieved. It should be noted that H0833 is incorrectly printed as H0835 on the Star ODDI but Seastar 7.70 programme registers it as H0833. Star ODDIs C8928, C8928, C8930 and C8984 were calibrated on CTD05 to 100 m. Star ODDIs recovered from below the frame (S7561, S7652, S7563, S7564, S7566 and H0457) were calibrated during CTD012 at 500m.

All Star ODDIs were deployed on 04.06.2018 on the PAP1 mooring tied to the buoy, chain, frame and to 1000 m below the frame (Table below). As H0833 did not record temperature or pressure from the DY077 deployment, S7727 was also fixed to the frame at 30 m as a backup. The new measurement sequence for deployment on JC165 was set in single mode, with an interval of 10 minutes from 06:00 on 04.06.2018. All Star ODDIs were secured to the buoy, frame, chain and rope using cable ties and tape.

*Summary of Star ODDIs deployed at PAP1 on DY077 and recovered on JC165*

SN	Type	Depth (m)	Position	Interval type	Deploy Date	Deploy Time	Recovery Date	Recovery Time	Battery remaining	Calibration Date	Max. depth (m)
C8928	DST CENTI	5							86%	25.10.2016	100
C8929	DST CENTI	10							86%	25.10.2016	100
C8930	DST CENTI	15							86%	25.10.2016	100
C8984	DST CENTI	20							87%	10.12.2016	200

## Sensor calibration

CTD sampling - The CTDs were used primarily to test sensors and releases although samples were also taken to look at typical profiles in the region, for sediment trap water, micro-plastic analysis and method development. The new OTEG phosphate and nitrate analyser were also put onto the frame and triggered to start measurements once sub-merged. As these sensors took up room on the frame only 22 of the 24 Niskin bottles were used during JC165.

The first cast was shallow and used to test the CTD instruments. The 2<sup>nd</sup> cast failed so CTD 03 was used for pre-deployment validation of the shallow PAP1 sensors. The wetlabs fluorometer and the Cyclops fluorometer were tested against each other and against the extracted chlorophyll samples. The

star oddis, SeaGuard O<sub>2</sub> optode and PAP1 microcats were also tested on the shallow CTD station 003 for comparison with the CTD and bottle oxygen measurements. There were three 7 minute stops specifically for the microcat ODO sensors. CTD004 was the first deep station and was used to test the PAP3 microcats and releases. Three 20 minute stops were used to capture a sample for the OTEG nutrient analyser. The post-deployment validation check of shallow PAP1 sensors was CTD cast 005 (and CTD010 for the shallow microcats). The deep microcat was tested on CTD cast 009. Post-deployment checks on the Star Oddis were made on CTD cast 12. This is summarised in the table below.

*A summary of sensors (additional to the CTD sensors and OTEG nutrient analysers)  
attached to the rosette*

CTD Cast	Sensor type	Serial number
003	<b>Shallow Pre deployment sensors:</b> Seaguard Turner fluorometer (OFF) Seaguard optode Wetlab fluorometer FLNTSUB Microcat 37imp ODO Microcat 37imp ODO Microcat 37imp ODO Microcat 37imp ODO Star oddi DST centi Star oddi DST centi Star oddi DST tilt	21100373 2824 269 16503 10315 6904 6915 8969 8967 H0786
004	<b>Deep Pre deployment sensors:</b> PAP3 microcats & releases Microcat sbe Microcat sbe	7300 9469
005	<b>Shallow Post deployment sensors:</b> Wetlab fluorometer FLNTSUB Star Odi DST Centi Star Odi DST Centi Star Odi DST Centi <b>Shallow Pre deployment sensors:</b> Seaguard flurometer (ON) Seaguard optode	3050 C8984929 C8930 C8928 21100373 2824
007	<b>Shallow Post deployment sensors:</b> Seaguard flurometer Seaguard optode 4330 Seabird ODO (stopped logging)	2103960 2001 10535
009	<b>Deep Post deployment sensors:</b> PAP3 microcat	9476
010	<b>Shallow Post deployment sensors:</b> Microcat (frame) Microcat (keel)	10535 9030
012	<b>500m cast for star oddis post deployment below frame</b>	S7561, 7562, 7563, 7564, 7565, 7566. Tilt H0457

In total we had 13 CTD stations (with no bottle samples from CTD001 and 002). The station numbers and positions are shown in the table below for the stations that will be providing data to BODC.

*CTD station positions, seabed and cast depth*

CTD cast (and station)	Latitude (N) [DD MM.MM]	Longitude (W) [DD MM.MM]	Seabed depth (m)	Cast max. depth (m)
CTD003 (03)	49 00.19	16 23.67	4848	100
CTD004 (06)	48 59.28	16 23.33	4849	4820
CTD005 (12)	49 00.16	16 29.60	4838	100
CTD006 (14)	48 59.67	16 24.04	4840	4830
CTD007 (23)	49 00.38	16 28.29	4838	100
CTD008 (24)	49 00.38	16 28.29	4846	2000
CTD009 (32)	49 00.06	16 30.19	4848	4838
CTD010 (45)	49 00.01	16 30.51	4838	100
CTD011 (46)	49 00.14	16 30.51	4836	4827
CTD012 (69)	48 56.71	16 25.60	4806*	500
CTD013 (70)	48 56.71	16 25.60	4810*	4800

*\* N.B. Probably uncorrected soundings*

On each occasion that samples were taken then the order of sampling followed was: Dissolved oxygen, Dissolved Inorganic Carbon (DIC), inorganic nutrients, salinity and associated parameters from the top 200m. The associated parameters from the surface samples were chlorophyll, SFC and PIC. These surface samples were filtered and frozen as appropriate. The PIC samples will be analysed ashore. On some casts samples were also taken for genetic analysis (see report by Rob Young).

DIC samples were preserved with 100ul of saturated mercuric chloride and will be analysed on the NOC Vindta at NOC for Dissolved Inorganic Carbon (DIC) and Total Alkalinity (TA). Duplicates were taken from each station (usually from the deepest Niskin fired). Nutrient samples were collected in centrifuge tubes and frozen for analysis of inorganic nutrients (NO<sub>2</sub>+NO<sub>3</sub>, phosphate and silicate) using the Quattro auto-analyser at NOC. Sufficient sample was taken for duplicate analysis.

Generally, 3 salinity bottle samples were taken from each cast, for analysis on-board at the end of JC165. The samples were analysed on board and the calibration curve (from stations 4-13) was as follows:

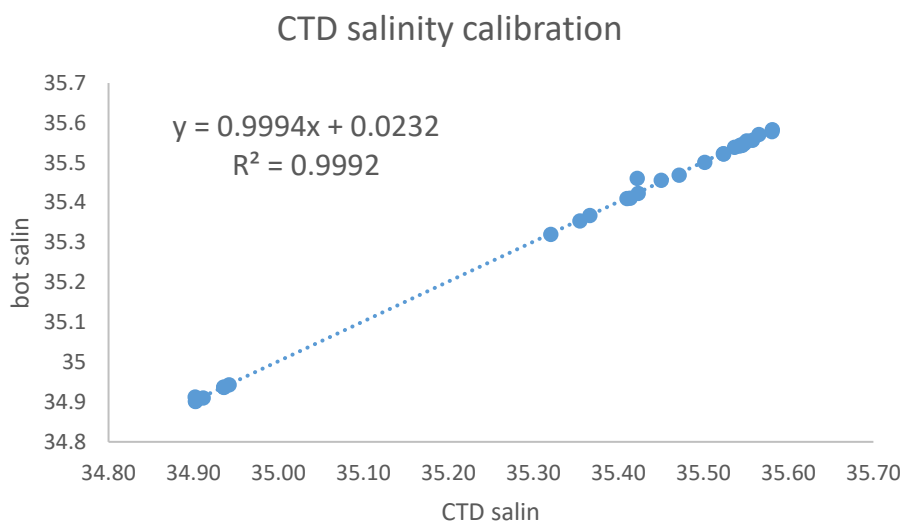

Chlorophyll samples were filtered and frozen for analysis on JC165. The oxygen bottle samples were fixed on deck, returned to the deck laboratory and analysis was started within 4 hours of collection.

Oxygen analysis on board - In total 100 samples were analysed for dissolved oxygen using a modified Winkler technique. An amperometric end point method was used, following the titration using an electrode to a set end point. Thiosulphate titrant was delivered using the new Ti-touch instrument (full duplicates were taken on cast 03 to check the Ti-touch alongside the Titrino 794, the results were identical and the Ti-touch was used throughout the rest of JC165).

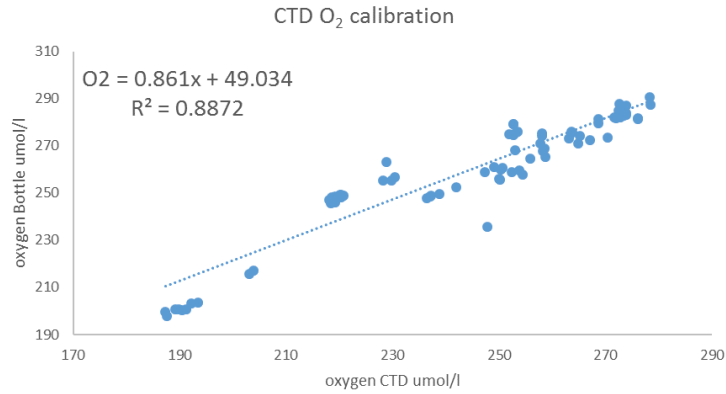

*Photo shows the two oxygen analysis systems setup on JC165 (left: Ti-touch, right: Titrino). New Ti-touch dissolved O<sub>2</sub> amperometric end point equipment set up for O<sub>2</sub> analysis on JC165*

The method was standardised using 1ml additions of 0.01N OSIL iodate (3 bottles were used during JC165). The normality of the thiosulphate was  $0.0987 \pm 0.0007$

Duplicate samples were taken on each cast (usually from the deepest depth). The average duplicate difference was 0.76  $\mu\text{mol/l}$  (0.3%), which is higher than would be expected (0.1%). The use of newer bottles should be considered in future. The temperature was taken on deck to account for any changes in bottle volume. The CTD oxygen data was converted into  $\mu\text{mol/l}$  for comparison with the bottle data.





*Overall relationship between the bottle oxygen and CTD oxygen data*

This equation can be applied to the CTD oxygen data (see the figure below). The final merged bottle oxygen data are available in a file called: 'JC165-bottle-oxygen'. Bottle oxygen data still has a high offset of ~20 umol/kg at depth but the calibration is adequate for the surface dissolved oxygen sensors.

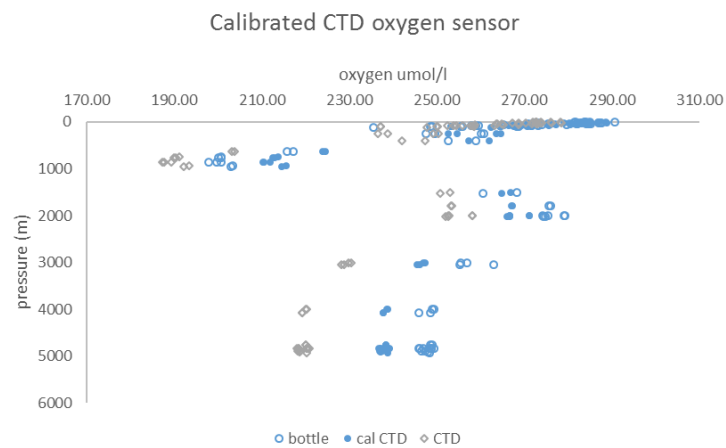

*Oxygen profile data from the CTD seabird sensor (uncalibrated and cal=calibrated) compared with bottle oxygen data*

The full depth profiles show a clear oxygen minima around 850 m (Med water influence) and oxygen increases again around 2000 m before decreasing in the Lower deep water. The shallow profiles show the change in MLD between casts and increases in dissolved oxygen corresponding to the changing depth of the DCM.

Underway sampling and CO<sub>2</sub> measurements - The NOC underway CO<sub>2</sub> recording system (designed by Campbell Ocean data) was set up at towards the end of JC165 (7<sup>th</sup> June). This unit was connected to the non-toxic (NT) seawater supply in the chemistry lab. Bottle samples were taken from the non-toxic (NT) supply seawater at the sampling point next to the thermosalinograph (TSG) in the bottle annex, 2-3 times per day. These samples were preserved and will be analysed for DIC and TA at NOC then

calculations will be made of pCO<sub>2</sub> for comparison with the NOC underway pCO<sub>2</sub> systems. Frequent salinity samples were taken throughout JC165, and salinity analysis was done on-board at the end of JC165 and this will be used to calibrate the TSG. On three occasions, oxygen samples were taken to compare with the optodes in the NOC underway system.

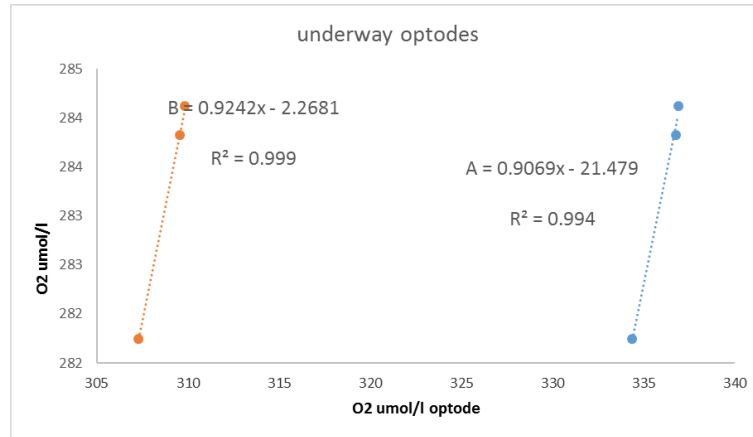

*Calibration of the underway optodes*

The system comprised of a plastic water tank containing an open head Pro-Oceanus CO<sub>2</sub> ProCV sensor (SN 38-492-75 with internal 56°C temperature) set to a 6 hour cycle of zero measurements, starting mid-day (where the CO<sub>2</sub> is stripped using the internal ascarite tube). The zero is used to correct for any sensor drift and as measurements take a few minutes to recover following the zero sampling was avoided at this time. In addition, the tank housed two Aanderra 4330 oxygen optodes (SN 2001 and 1282) that also measured temperature and an Aanderra conductivity sensor (SN 955). A flow meter was used to monitor the flow (generally 20.1 litre/min). These were all connected to an interface box providing 12 V power. The RS-232 serial communication signals were passed to a laptop and recorded into daily files. Values were noted manually and recorded to a log sheet 2-4 times a day, generally coinciding with sampling. The underway CO<sub>2</sub> systems were run until 11<sup>th</sup> June, just prior to the NT being switched off. The CO<sub>2</sub> results will need to be corrected for using atmospheric pressure and temperature. The temperature at seawater inlet, in the TSG and NOC systems will potentially differ as they use different temperature sensors and because they are not located in the same place. The temperature in the tank was on average 0.35°C higher than the TSG readings and the calculated salinity was 0.39 PSU lower. There will be a comparison with CO<sub>2</sub> calculations (using CO<sub>2</sub>SYs) once the DIC/TA samples have been analysed. The underway oxygen data showed an inverse relationship to the CO<sub>2</sub> in the NOC system (see Figure below).

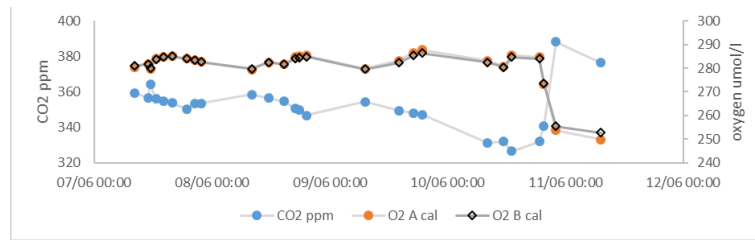

*CO<sub>2</sub> (ppm) and O<sub>2</sub> (umol/l) from the NOC underway CO<sub>2</sub> equipment*

## 12. PAP3 - Sediment traps scientific report

Corinne Pebody

For the moorings details see the moorings report. The 2018/19 PAP3 sediment trap moorings were deployed on 25<sup>th</sup> April 2018 and the 2017/18 traps recovered on 27<sup>th</sup> April 2018. Traps A, B, C and D, 2 x norteks and 1 x microcat were recovered and had all worked successfully.



On recovery, bottles were removed and lids screwed on before storing to the CT lab. The bottles were photographed and the pH checked. Then 1 ml of formalin was pipetted to the bottles, an extra layer of parafilm was added then the lids replaced and samples stored in the CT lab.

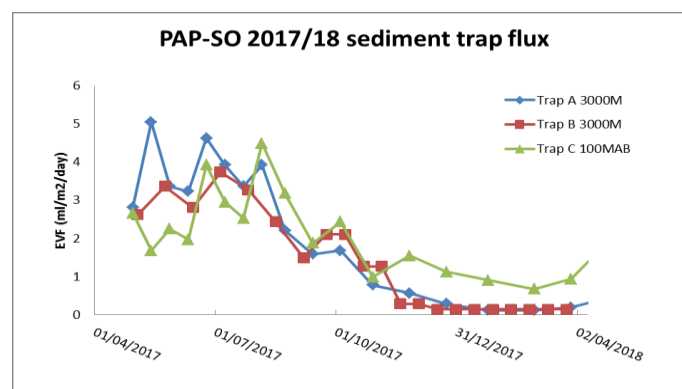

The bottles were measured for estimated volume flux; a quick but reasonable measure of the particle flux over the deployment year. The EVF was low relative to previous years, even during the bloom. Whilst the 100 mab trapped flux in 2018, both the 3000 m failed to collect. Both traps had rotated and the pH was 8.0 so not washed out so the low trapping is not explained but is not the zero recorded.

The microcat and Norteks were downloaded.

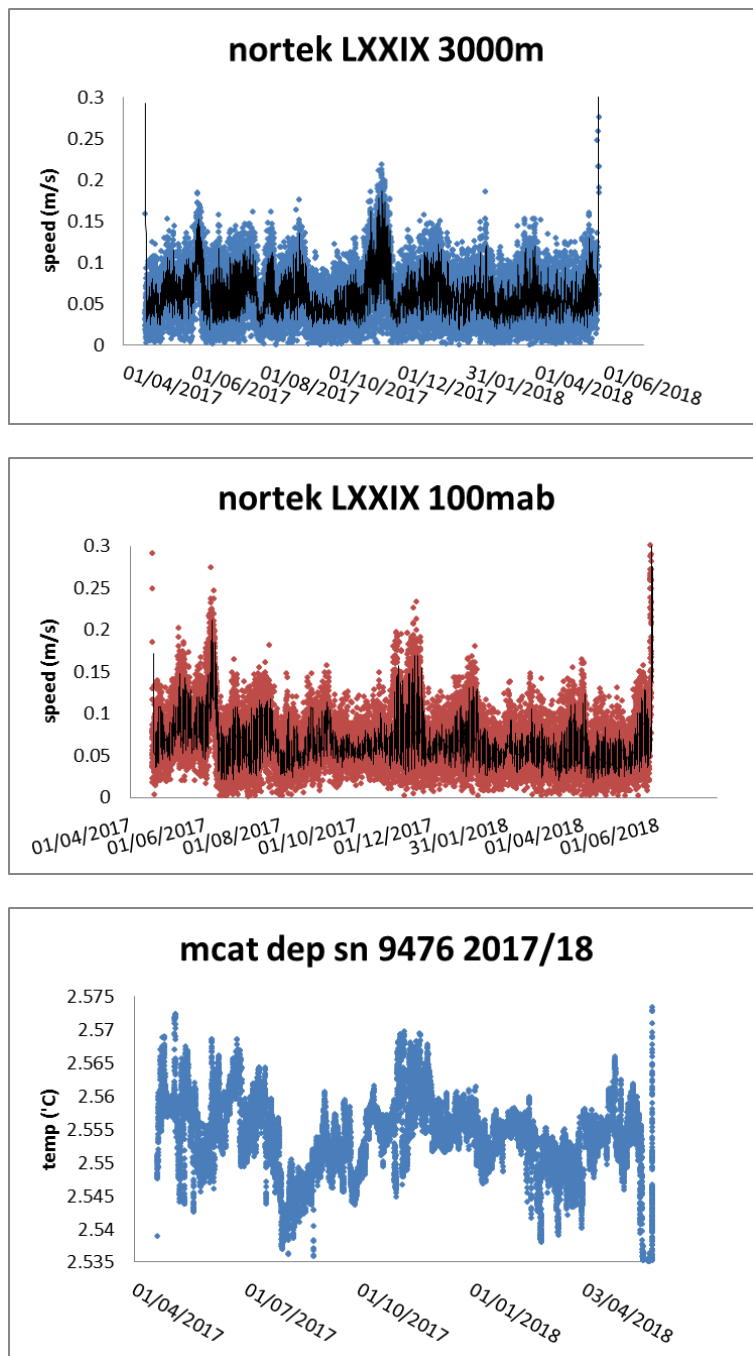

The Norteks showed comparable current speeds at 3000 m and 100 mab so it was likely not high currents that prevented trapping. The microcat was deployed on CTD to 4800 m and the depth, temperature, and salinity calibrated against the CTD. Calibrations were applied to recovered data and temperature variation for the year was plotted.



The inverted trap bottles were photographed individually and most bottles were empty though several had medusae and one medusae and amphipod. This was the fourth year of deployment and third of successful recovery. In the three years of samples, no particles were collected, only animals and mostly medusae. The inverted trap was not deployed for 2018/19.

### 13. Zooplankton nets

Corinne Pebody



The WP2, 200  $\mu\text{m}$  net was deployed to 200 m in a series of paired vertical hauls. Prior to each haul, the net was checked for twists and that the tap was closed, then the net was lowered over the side using the Rexroth winch over the starboard side. Maximum depth was 200 metres where the deployment was paused for a minute to allow the net to hang straight before the being brought up at approx. 10 metres per minute.

On recovery the net was hosed down from the outside with seawater and the cod end emptied into a white bucket. Hosing was repeated and time allowed for zooplankton to settle into the bottom of the cod end. Samples were then either, transferred to 2 litre bottles and preserved by adding borax buffered formalin to an approximate concentration of 5%. Alternatively, the sample was sieved through a series of meshes, 2 mm, 1 mm, and 200  $\mu\text{m}$  and transferred to cryo vials and stored in the  $-80^{\circ}\text{C}$  freezer. Any pteropods were removed for photography.

A second net was used to collect foraminifera for the Foster lab. The 63  $\mu\text{m}$  mesh net was used for this but still dipped to 200m. Samples were preserved in mercuric chloride.

Future work: At NOC, formalin preserved samples will be split with a Folsom splitter. A sub sample will be picked to remove zooplankton greater than 2 mm. Remaining meso zooplankton will be analysed using flow cam technology to ascertain size and abundance distribution.

Stn JC165-	Net no.	Sample type	Start date 2018	Start time	Lat. N	Long. W	End date 2018	End time	Depth (ucm)*	Sampling
20	01	Noon	27/05	10:56	49 00.658	16 28.737	27/05	11:07	4809	preserved in formalin 2 litre bottles
20	03	Noon	29/05	12:23	49 00.320	16 29.933	29/05	12:46	4808	preserved in formalin 2 litre bottles. This pair of nets had significantly more than the previous net – much greener/browner in colour (3 sample bottles)
21	02	Noon	27/05	11:22	49 0.533	16 28.540	27/05	11:46	4809	Sieved into >2mm; ,<2mm; >1mm; <1mm>200µm; frozen at - 80°C
21	04	Noon	29/05	12:51	49 0.285	16 30.032	29/05	07:20	4808	Sieved into >2mm; ,<2mm; >1mm; <1mm>200µm; (4 cryovials of 200µm size) frozen at - 80°C
42	05	Day	01/06	10:44	49 01.770	16 30.081	01/06	11:03	4810	63 µm net preserved in mercuric chloride( 2 sample bottles)
43	06	Noon	01/06	11:11	49 01.676	16 30.228	01/06	11:31	4807	preserved in formalin 2 litre bottles. ( 2 sample bottles)
44	07	Noon	01/06	11:35	49 01.596	16 30.362	01/06	11:52	4807	Sieved into >2mm; ,<2mm; >1mm; <1mm>200µm; (4 cryovials of 200µm size) frozen at - 80°C
48	08	Midnight	02/06	23:31	48 58.959	16 32.854	03/06	00:04	4737	preserved in formalin 2 litre bottles
49	09	Midnight	03/06	00:21	48 58.938	16 33.342	03/06	00:53	4737	Sieved into >2mm; ,<2mm; >1mm; <1mm>200µm; (4 cryovials of 200µm size) frozen at - 80°C
50	10	Midnight	03/06	01:02	48 58.991	16 33.361	03/06	01:25	4749	63 µm net preserved in mercuric chloride( 2 sample bottles)
54	11	Midnight	03/06	23:36	48 58.893	16 33.310	03/06	23:56	4742	63 µm net preserved in mercuric chloride( 2 sample bottles)
55	12	Midnight	04/06	00:01	48 58.902	16 33.459	04/06	00:30	4751	Sieved into >2mm; ,<2mm; >1mm; <1mm>200µm; (4 cryovials of 200µm size) frozen at - 80°C
56	13	Midnight	04/06	00:35	48 58.962	16 33.767	04/06	01:06	4767	preserved in formalin 2 litre bottles x 2
60	14	Midnight	04/06	23:00	48 58.926	16 32.908	04/06	23:16	4737	preserved in formalin 2 litre bottles x 2
61	15	Midnight	04/06	23:23	48 58.941	16 32.951	04/06	23:53	4739	Sieved into >2mm; ,<2mm; >1mm; <1mm>200µm; (4 cryovials of 200µm size) frozen at - 80°C
62	16	Midnight	05/06	00:03	48 58.965	16 33.038	05/06	00:33	4741	63 µm net preserved in mercuric chloride( 2 sample bottles)

\* uncorrected metres water depth

With thanks to Dan, Brian, Charlotte, Virginia, Greg, Ronnie, Kevin and Jason.



## 14. Benthic systems and sampling

Brian Bett, Giulio Barone, Noëlie Benoist, Virginia Biede, Carolina Camargo Laura Carugati, Luciana Genio, Anita Hollingsworth, Simone Pfeifer, Rob Young, & Henry Ruhl

The benthic group aboard RRS *James Cook* cruise 165, aimed to continue time-series observations of the benthos and seafloor of the Porcupine Abyssal Plain Sustained Observatory site, originally initiated in 1985. Standard objectives for the 2018 cruise included: (i) a replicated set of seabed samples collected by Megacore from the PAP central location to serve a variety of purposes, (ii) duplicate otter trawl samples of the megabenthos to serve a variety of purposes; (iii) duplicate amphipod trap sample sets; and (iv) the deployment of a long-term (1-year) Bathysnap time-lapse seafloor camera system, and the recovery of a deployed system (DY077-084; RRS *Discovery* cruise 077, 2017). In addition, an expanded benthic programme for 2018 also included: (v) seafloor photography (HyBIS system) at the PAP central location, and (vi) further Megacore sampling and seafloor photography at the “AESAs” hill location (RRS *Discovery* cruise 377/8; location H3 of RRS *James Cook* cruise 062). With the exception of the failure to recover the DY077-084 Bathysnap mooring, these objectives were met or exceeded during the course of the cruise, as described below.

### **Benthic operations at PAP Central**

Coring operations at the PAP Central site were based on randomly selected points (ArcMAP 10.5 native function) within a 500 m radius buffer (geodesic; ArcMAP 10.5 native function) of the nominal centre of the “central coring area”, 48° 50.22' N 016° 31.27' W. This area also corresponds with a fine-scale photographic grid survey carried out by Autosub6000 from RRS *Discovery* cruise 377/8, which forms the basis of a repeat survey by HyBIS during the present cruise.

### **Benthic operations at AESA hill H3**

Coring operations in the AESA hill H3 area were based on randomly selected points (ArcMAP 10.5 native function) within a polygon defined by the intersection of the area of a fine-scale photographic grid survey carried out by Autosub6000 from RRS *Discovery* cruise 377/8 and ‘band C’ of a depth stratified (4740-4790 m) coring programme carried out during the same cruise. The same fine-scale photographic grid survey formed the basis of a repeat survey by HyBIS during the present cruise.

## Summary of benthic operations Station List

Station Number	Gear code	Date 2017	Time UTC	Latitude	Longitude	Dep. (m)	Sou. (m)	Comment
DY077-84	BSNAP	25/04	16:03	49 00.387	16 23.866	4846	4846	No response from release
		22/05	07:30	49 00.387	16 23.866	4846		Assume lost
JC165-04	MgC08+2	22/05	20:34	48 50.076	16 31.597	4844	4844	9/10 good cores
JC165-05	MgC08+2	23/05	01:27	48 50.427	16 31.239	4842	4842	8/10 good cores
JC165-07	MgC08+2	23/05	20:58	48 50.391	16 31.293	4842	4842	9/10 good cores
JC165-08	MgC08+2	24/05	01:51	48 50.321	16 31.408	4841	4842	9/10 good cores
JC165-09	HyBIS	24/05	10:20	48 50.520	16 31.314	4844	4844	Two N-S lines run
		24/05	15:17	48 50.502	16 31.295	4844		c. 3050 seabed images
JC165-10	MgC08+2	24/05	21:24	48 50.469	16 31.315	4841	4841	8/10 fair cores
JC165-11	MgC08+2	25/05	02:48	48 50.487	16 31.450	4841	4841	6/10 good cores
JC165-15	MgC08+2	25/05	20:31	48 50.203	16 31.059	4841	4841	5/10 good cores
JC165-16	MgC08+2	26/05	01:16	48 50.199	16 31.498	4844	4844	10/10 good cores
JC165-17	HyBIS	26/05	09:41	48 50.475	16 31.138	4844	4844	Three N-S lines run
		26/05	16:41	48 49.976	16 31.082	4844		c. 4420 seabed images
JC165-18	MgC08+2	26/05	22:12	48 50.366	16 31.061	4842	4842	8/10 good cores
JC165-19	MgC08+2	27/05	02:53	48 50.241	16 31.413	4842	4842	6/10 good cores
JC165-22	ATRAP	27/05	14:14	49 00.280	16 28.262	4848	4848	Small / fair catches
		29/05	09:05	49 00.280	16 28.262	4848		Soak time 43 hours
JC165-25	MgC08+2	27/05	22:39	48 50.318	16 31.228	4841	4841	6/10 good cores
JC165-26	MgC08+2	28/05	03:13	48 50.289	16 30.914	4844	4844	9/10 good cores
JC165-27	HyBIS	28/05	08:14	48 50.490	16 31.576	0	4844	Aborted mid-water
		28/05	08:31	48 50.490	16 31.575	20		No seabed images
JC165-28	HyBIS	28/05	13:04	48 50.509	16 31.623	4844	4844	Two N-S lines run
		28/05	16:49	48 50.505	16 31.606	4844		c. 2370 seabed images
JC165-29	MgC10	28/05	22:33	48 50.205	16 31.299	4842	4842	9/10 good cores
JC165-33	MgC10	29/05	22:08	48 50.358	16 30.968	4841	4841	9/10 good cores
JC165-34	MgC10	30/05	04:14	48 50.339	16 31.024	4841	4841	10/10 good cores
JC165-35	HyBIS	30/05	12:29	48 50.497	16 31.442	4844	4844	Two N-S lines run
		30/05	16:28	48 50.504	16 31.395	4844		c. 2510 seabed images
JC165-36	MgC10	30/05	19:51	48 50.168	16 31.279	200	4841	Aborted, scroll problem
JC165-37	MgC10	30/05	23:24	48 50.164	16 31.297	4841	4841	9/10 good cores
JC165-38	HyBIS	31/05	12:46	48 59.348	16 33.197	4765	4785	Two N-S lines run
		31/05	16:18	48 59.454	16 33.164	4800		c. 2250 seabed images
JC165-39	MgC08+2	31/05	21:28	48 58.959	16 33.066	4777	4777	9/10 good cores
JC165-40	MgC08+2	01/06	01:47	48 59.029	16 33.007	4782	4782	8/10 good cores
JC165-41	ATRAP	01/06	08:45	49 00.281	16 28.258	4844	4844	Small / fair catches
		05/06	06:25	49 00.281	16 28.258	4844		Soak time 94 hours
JC165-47	MgC08+2	02/06	21:29	48 58.973	16 32.896	4783	4783	0/10, no samples
JC165-51	MgC08+2	03/06	03:51	48 58.914	16 33.131	4777	4777	8/10 good cores
JC165-52	HyBIS	03/06	10:11	48 59.391	16 33.060	4758	4780	Three N-S lines run
		03/06	16:30	48 58.899	16 32.842	4807		c. 4000 seabed images
JC165-53	MgC08+2	03/06	21:25	48 58.902	16 33.352	4790	4790	8/10 fair cores
JC165-57	MgC06+2	04/06	03:28	48 58.961	16 32.874	4783	4783	8/8 good cores
JC165-59	MgC06+2	04/06	21:01	48 58.923	16 32.915	4779	4779	8/8 good cores
JC165-63	MgC06+2	05/06	02:41	48 58.975	16 33.089	4778	4778	7/8 good cores
JC165-64	OTSB14a	06/06	01:20	48 58.201	16 53.297	4834	4839	Small, clean, catch
		06/06	02:36	48 55.316	16 49.452	4844		Distance run c. 7.1 km
JC165-65	HyBIS	06/06	12:43	48 59.386	16 33.445	4771	4788	Three N-S lines run
		06/06	18:18	48 58.855	16 33.286	4800		c. 3535 seabed images
JC165-66	MgC06+2	06/06	23:18	48 58.978	16 33.282	4792	4792	8/8 good cores
JC165-67	MgC06+2	07/06	03:24	48 58.820	16 33.216	4777	4777	8/8 good cores
JC165-68	BSNAP	07/06	07:56	49 00.309	16 27.853	4842	4842	With colonisation rigs
				49 00.300	16 27.984			Triangulated position as 'end'
JC165-71	MgC06+2	07/06	21:51	48 58.910	16 33.283	4788	4788	8/8 good cores
JC165-72	MgC06+2	08/06	02:02	48 58.880	16 33.036	4772	4772	5/8 good cores
JC165-73	HyBIS	08/06	08:45	48 59.384	16 33.404	4797	4823	Four lines run
		08/06	16:31	49 00.166	16 32.864	4839		c. 4910 seabed images
JC165-74	OTSB14a	09/06	01:42	48 50.728	16 54.518	4841	4843	Fair, clean, catch
		09/06	03:47	48 55.629	16 53.299	4844		Distance run c. 9.2 km
JC165-75	HyBIS	09/06	11:47	49 07.482	16 39.639	3945	4247	Single line run
		09/06	14:30	49 07.074	16 38.035	4247		c. 1720 seabed images

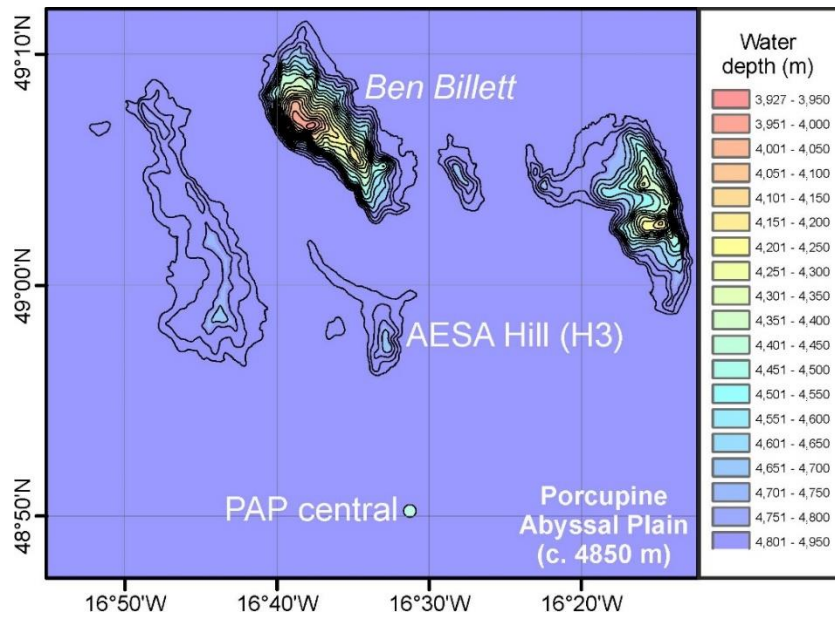

General location map of the Porcupine Abyssal Plain Sustained Observatory area indicating named areas and features studied during the present cruise. This base map is used throughout the following and is based on a smoothed version of the combined bathymetry from RRS *Charles Darwin* cruise 158 and RRS *James Cook* cruise 062, with some subjective hand editing of the derived contours for clarity. The datum is WGS84 and the projection World Mercator.

### Moorings

Two small bottom moored systems were employed during the course of the cruise: “Bathysnap” (BSNAP), a time-lapse seafloor photography system intended for long-term deployment (c. 1-year), and an “Amphipod trap” (ATRAP), carrying four simple baited traps for short-term deployments (1-2 day).

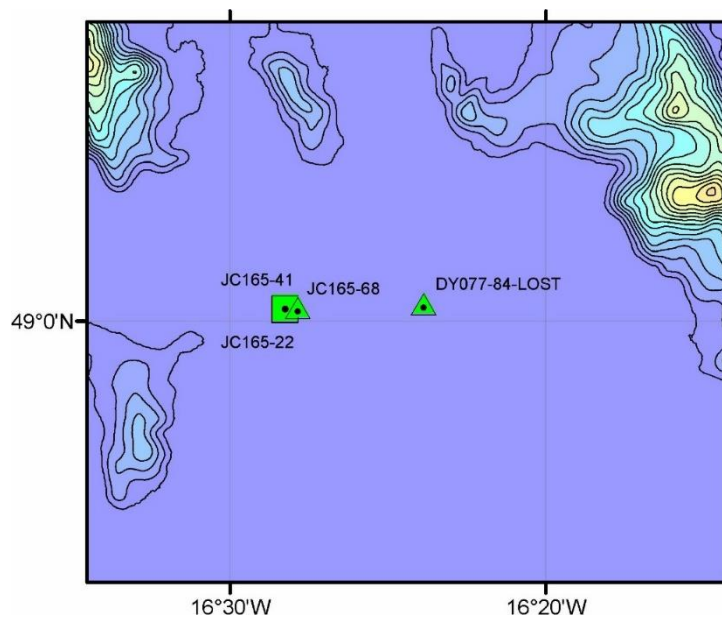

Benthic group mooring stations. Amphipod traps as squares; Bathysnaps as triangles.

## **Bathysnap**

**BSNAP DY077-084 (deployed RRS *Discovery* cruise 077, 2017) – LOST.** The intended recovery of this system (new Kongsberg OE14-408-0016 digital stills camera, and OE11-442-0016 flashgun, powered and controlled by an Oceanlab Oceanback III unit) failed when no credible acoustic contact could be made with the mooring. Release codes were sent but the mooring did not surface and is assumed to be lost. Note, a second system deployed long-term at the FRAM observatory failed as a result of leaks to both camera and flash (incorrect pressure case securing bolts for long-term operation). It is conceivable that one or other of the pressure cases on DY077-084 suffered a catastrophic failure, damaging the acoustic release in the process. Options for relocation of the mooring at the seabed (e.g. HyBIS / ROV *Isis*) on a future cruise will be investigated. Note the Bathysnap frame is carrying recolonisation units that may yet yield valuable samples.

**BSNAP JC165-068 – DEPLOYED – recovery planned mid-2019.** After reconditioning, the second Bathysnap system (Kongsberg OE14-408-0016 digital stills camera, and OE11-442-0016 flashgun, powered and controlled by an Oceanlab Oceanback III unit), was deployed as Station JC165-068 during the present cruise. Again, the frame also carries a number of recolonisation units (see further below and separate LO<sup>3</sup>CAted project report). The mooring and instruments were rigged and deployed in conventional fashion at position 49° 00.309' N 016° 27.853' W, with seabed position later confirmed by acoustic ranging at 49° 00.300' N 016° 27.984' W. The mooring carried a flashing light (s/n A08-016) and acoustic release AR861, s/n 1919, codes:

**ARM 1A7D**

**REL 1A55**

As per preceding deployment (DY077-084 ) the new frame required some modifications at sea: the Allan key hole accessing the release locking mechanism was out of alignment (vertically), flashgun clamp spacing was too wide, flashgun bracket was misaligned relative to the photographic axis – **if this frame continues in use, the relevant drawings should be amended prior to construction of another unit.**

Camera set-up was essentially as described in the RRS *Discovery* cruise 077 report. It is briefly recapitulated here, updated with observations from the present cruise.

**Camera settings (N.B. serial to USB convertor may be needed).** Select a range of camera settings as appropriate to the intended subject, deployment duration, image quality, etc.:

- Empty memory card. Fit USB download cable from camera to laptop. Select “settings” tab, click “Image Download” button. Open laptop file manager, navigate to camera storage media, delete any images and image folders. Click “Image Download” button to end.
- GUI upper panel, set “ZOOM” to fully wide
- GUI upper panel, set “MODE” to Manual

- GUI upper panel, set “ISO” to 100
- GUI upper panel, set “EXP COMP” to 0
- Use “control dial” to set shutter speed to 1/250
- Use “control dial” to set aperture to F5.0
- Press manual focus (MF) button (= up arrow), use “control dial” to set focus distance to about 2-3 m.
- Press Function/Set button (FUNC.) (blue circle between arrows), opening menu, scroll down with arrow key to image format option, and scroll right with arrow key to select “RAW”, press FUNC. to select and exit menu.
- Press FUNC., opening menu, scroll down to flashpower setting, scroll right/left to achieve “1/4” power option, press FUNC. to select and exit menu.
- Press menu button (MEN), press right arrow to enter tools (spanner and hammer symbol)
- Scroll down to file numbering and set to “Continuous”
- Scroll down to Create Folder and set “Monthly”
- Scroll down to Date/Time, and set current date and UTC time using arrow button, press FUNC. (= OK) to accept settings
- Scroll down to “RAW + FL” (F is a quadrant symbol representing ‘fine’), set to “OFF”
- Scroll down to Save Setting and select “C2”, press FUNC. to accept “C2” setting. **THIS IS CRITICAL.**
- Power off the camera (i.e. switch off bench power supply)
- Power on the camera (i.e. switch on the bench power supply)
- [repeat manual focussing – not clear camera holds this setting?]
- Select “Settings” tab on the GUI, and select “Setup...” under the “Intervalometer” heading, untick ‘Use startup delay’, set all other value boxes to zero except ‘interval’ set to 10 seconds, click OK
- **CRITICAL CHECK** – check that the red flash symbol is displayed on the TV monitor
- If the Red flash symbol is not on, try the flash button in the upper part of the Settings panel of the GUI (be patient). If Red flash symbol is on – continue procedure.
- Aim the Kongsberg camera remote control handset at the camera window and press button “A”. You should now see (on the TV monitor) the camera switch to the saved “C2” mode and then begin firing at 10-second intervals. After 2 or 3 shots fire, power off the camera (i.e. switch off bench power supply) and it is ready for connection to the OCEANBACK.
- If the camera does not change to “C2” mode and begin firing – start over.

### **OCEANBACK timer settings (N.B. terminal emulator may be required)**

- Set-up terminal emulator (COM port number, 115200 baud rate, 8 data bits, 1 stop bit, parity as none, flow control as none)
- Connect OCEANBACK COMMS port to laptop via supplied cable (device manager to check assigned COM port if necessary)
- Open session in terminal emulator
- Connect the supplied blind start cable to the OCEANBACK start port
- After short delay, OCEANBACK should boot up to menu
- Type ‘s’ to select “Set Start Delay Time”
- Type ‘00:00’ and press enter – watch screen to see OCEANBACK confirm 0 seconds entry – this appears on screen only briefly !
- Type ‘p’ to select “Set Repeat Period” (note printed manual suggests input format will be “HH:MM”, but appears to be “DD:HH:MM”)
- Type ‘00:08:00’ and press enter – watch screen to see OCEANBACK confirm 28800 seconds entry – this appears on screen only briefly !
- Type ‘r’ to select “Repeat Loop Count”
- Type ‘2000’ and press enter
- You can now let the menu count down happen, or press ‘b’ to “Begin Acquisition” immediately
- In either case, the terminal should now display  
“Beginning acquisition phase  
Taking initial photo  
<date time stamp> TAKE\_PHOTO  
Starting timed sequence”
- The next <date time stamp> TAKE\_PHOTO should happen 8-hours later

- **DO NOT REMOVE THE START CABLE** – the manual suggests this is possible, but bench tests suggest that the sequence will not or not reliably restart.



Bathysnap DY077-084 as deployed, note 4 larval traps top centre of frame around release position, and tube of colonisation substrata on the rear upright on the flash side. This is now considered as lost, but it is possible that a future cruise could attempt to relocate.

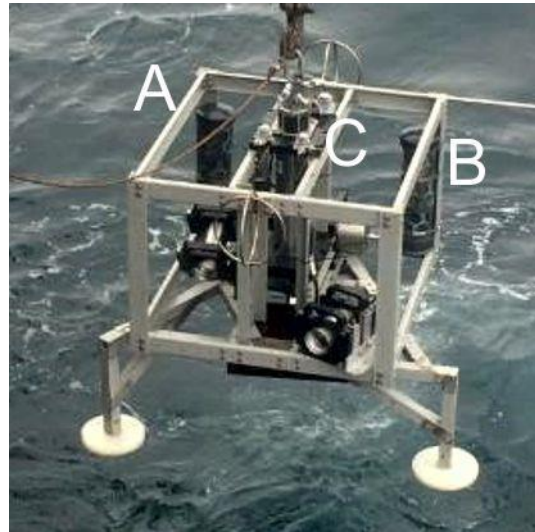

Bathysnap JC165-068 as deployed, carrying: two settlement frames (A, shell, wood, clinker; B, wood, shell, clinker) and four larval tube traps (C).

### Amphipod trap

The OBE upgraded DEMAR amphipod trap (carrying four double parlour acrylic traps) was deployed in the conventional manner on two occasions during the cruise. In both cases, all traps were baited with ‘standard British mackerel’. The mooring was of conventional form: lazy float – 15 m polyprop – Billings dan buoy – 15 m polyprop – 6-ball main buoyancy pack – 50 m braid – IXSEA MORS B2S type release. Mooring descent rate was estimated at 60 m min<sup>-1</sup>, and ascent rate at 38 m min<sup>-1</sup>. Summary tabulation of amphipod trap deployments:

Stn number	Start time		Position (DD MM.MMM N/W)				End time		Depth (m)	Soak time
JC165-022	27/05/2018	14:14	49	0.280	16	28.262	29/05/2018	09:05	4848	43 hours
JC165-041	01/06/2018	08:45	49	0.281	16	28.258	05/06/2018	06:25	4844	94 hours

**Sample processing:** Each trap was photographed on the frame with the Station number and either ‘top’ or ‘bottom’ (see below), removed from the frame, and placed in a large tray next to the sieving table. Trays were used to keep the pieces of the trap (i.e. funnel, screws, and crossed wires) after it was



dismantled to extract the amphipods. This allowed rebuilding each trap with their original pieces. Nitrile gloves were used at all times to avoid biological contamination of the samples. Amphipods were removed from the trap by gently washing the trap cylinder, funnel, and mesh, with filtered seawater above the sieving table that was used as a working station (two traps were processed at the same time in order to speed up the process). Specimens were retained on a 250  $\mu\text{m}$  sieve that was placed on a tray to prevent sample loss. The bait mackerel were examined in detail (dissected if necessary) to collect amphipods within the flesh. Specimens were transferred to absolute ethanol in 1500 ml UN certified plastic bottles and held in the 4°C temperature control room. Each bottle was labelled with Station number, position of the trap (i.e. top1, top2, bottom1, bottom2), date, and preservation method (i.e. ethanol). Examples of amphipods collected during JC165 are presented below. The majority of amphipods comprised small individuals (particularly from the first deployment), and about the same volume of individuals was collected from the second catch despite remaining about twice as long at the seabed.

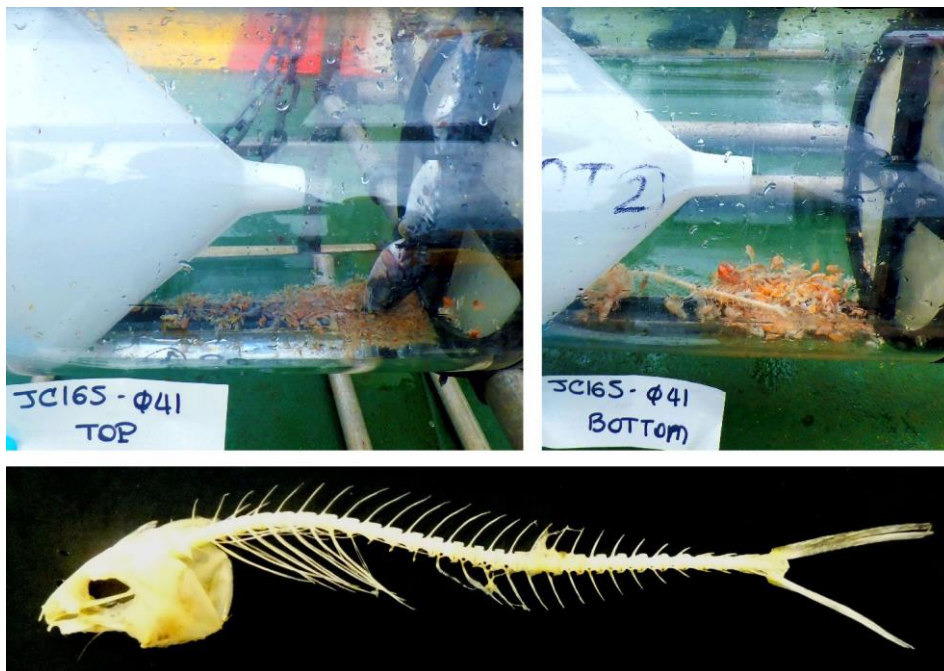

Example images of amphipod catches and bait remaining from Station JC165-041, note contrast between top and bottom traps.

### Wire deployments

**Megacore.** The NMFSS Megacore (ex-OBE version) was used for all coring operations during the cruise. It was rigged (standard two extra layers of lead plate) and operated in conventional fashion. Monitoring was successfully achieved via a Sonardyne USBL beacon mounted directly on the frame, that appeared to produce reliable and precise depth telemetry. The number and type of coring units fitted was varied to suit sampling needs and seabed conditions. Both “large” (100 mm ID) and “small” (59

mm ID) units were deployed, as identified in the Station List in the conventional manner (e.g. MgC<sub>xx+y</sub>, where xx is the number of large units and y is the number of small units). Coring operations began on the core warp, scrolling problems were evident in Stations JC165-010, 011, and 016, worsening in 026 and 029. Coring operations were then switched to the trawl warp, the first deployment (JC165-036) being aborted after the scrolling gear failed to move; subsequent deployments were completed without any further scrolling issues. General performance is noted in the following table:



Station	Location	Gear	Warp	Pull out tension (T)	Sounding (m)	Return	Typical length (cm) <sup>1</sup>
JC165-04	PAP central	MgC08+2	Core	5.3	4844	9/10 good cores	39
JC165-05	PAP central	MgC08+2	Core	5.3	4842	8/10 good cores	40
JC165-07	PAP central	MgC08+2	Core	5.4	4842	9/10 good cores	39
JC165-08	PAP central	MgC08+2	Core	5.2	4842	9/10 good cores	39
JC165-10	PAP central	MgC08+2	Core	5.3	4841	8/10 fair cores	37
JC165-11	PAP central	MgC08+2	Core	5.4	4841	6/10 good cores	39
JC165-15	PAP central	MgC08+2	Core	5.4	4841	5/10 good cores	41
JC165-16	PAP central	MgC08+2	Core	5.2	4844	10/10 good cores	40
JC165-18	PAP central	MgC08+2	Core	5.4	4842	8/10 good cores	40
JC165-19	PAP central	MgC08+2	Core	5.4	4842	6/10 good cores	39
JC165-25	PAP central	MgC08+2	Core	5.4	4841	6/10 good cores	35
JC165-26	PAP central	MgC08+2	Core	5.3	4844	9/10 good cores	40
JC165-29	PAP central	MgC10	Core	5.6	4842	9/10 good cores	40
JC165-33	PAP central	MgC10	Core	5.6	4841	9/10 good cores	41
JC165-34	PAP central	MgC10	Core	5.6	4841	10/10 good cores	40
JC165-36	PAP central	MgC10	Trawl	na	4841	No samples <sup>2</sup>	na
JC165-37	PAP central	MgC10	Trawl	3.7	4841	9/10 good cores	41
JC165-39	AESA hill H3	MgC08+2	Trawl	4.2	4777	9/10 good cores	38
JC165-40	AESA hill H3	MgC08+2	Trawl	3.6	4782	8/10 good cores	20
JC165-47	AESA hill H3	MgC08+2	Trawl	3.3	4783	No samples <sup>3</sup>	na
JC165-51	AESA hill H3	MgC08+2	Trawl	3.7	4777	8/10 good cores	19
JC165-53	AESA hill H3	MgC08+2	Trawl	3.6	4790	8/10 fair cores	19
JC165-57	AESA hill H3	MgC06+2	Trawl	3.8	4783	8/8 good cores	40
JC165-59	AESA hill H3	MgC06+2	Trawl	3.8	4779	8/8 good cores	39
JC165-63	AESA hill H3	MgC06+2	Trawl	3.8	4778	7/8 good cores	40
JC165-66	AESA hill H3	MgC06+2	Trawl	3.9	4792	8/8 good cores	40
JC165-67	AESA hill H3	MgC06+2	Trawl	4.1	4777	8/8 good cores	38
JC165-71	AESA hill H3	MgC06+2	Trawl	3.9	4788	8/8 good cores	38
JC165-72	AESA hill H3	MgC06+2	Trawl	3.6	4772	5/8 good cores	11

<sup>1</sup> Representative length of successful large cores. <sup>2</sup> Aborted for scrolling gear failure. <sup>3</sup> Returned all fired but empty bar one short bubbling core – presumed bad first seabed contact in swell.



Example core profile photographs from all successful Megacore deployments in the PAP Central area.



Example core profile photographs from all successful Megacore deployments in the AESA hill H3 sampling area.

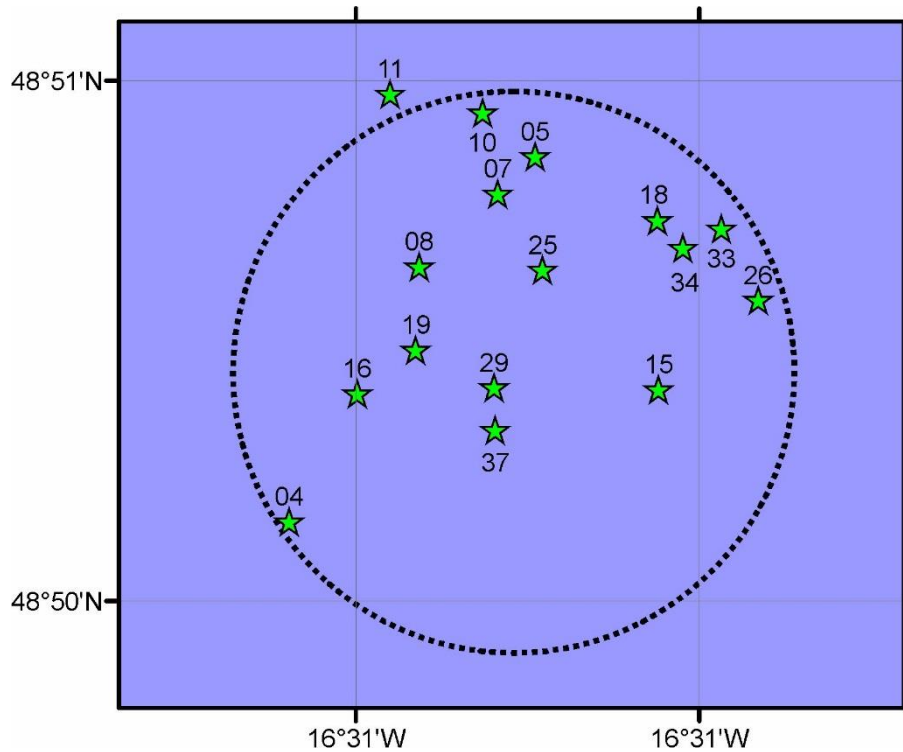

Successful Megacore stations in the 'PAP Central' coring area labelled as JC165-0xx; dotted circle is the 500 mm radius buffer defining the randomly sampled area.

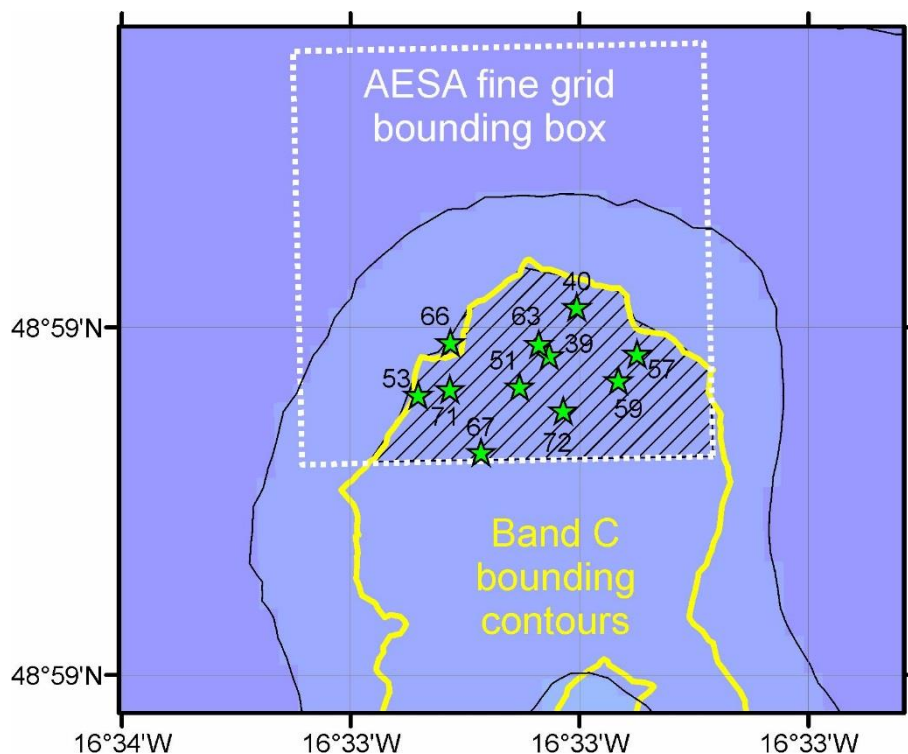

Successful Megacore stations in the AESA hill H3 sampling area labelled as JC165-0xx; hatched area represents the randomly sampled region defined by the intersection of the AESA fine grid bounding box and the band C bounding contours (4740-4790 m).

### Lab processing

Once the cores were removed from the Megacore, they were processed by four teams of two. Teams were allocated a sample type: (1) meio- and macrofauna, (2) microplastics and biogeochemistry, (3) eDNA, and (4) prokaryotic processing. When an extra scientist was available, they would process a small core on their own (i.e. for metazoan meiofauna or an extra core allocated for prokaryotic analyses). In teams, one person held the core tube in vertical position on a plunger while the other sliced the sediment. Details of slicing procedures to acquire the necessary sediment horizons are detailed below.

**Macrofauna (NOC-DST-OBE):** A minimum of four large tubes (100 mm ID) per deployment were allocated to macrofauna replicates, although fewer were taken on four occasions to provide at least one core for eDNA and prokaryotic analyses. Any additional cores were allocated to macrofauna. The overlying top water was siphoned into a 250 µm sieve and transferred into a bottle corresponding to the 0-1 cm sediment layer. Syringes were used to extract the small volume of remaining water if necessary. Slicing rings were used to measure the following horizons: 0.0-1.0, 1.0-3.0, 3.0-5.0, and 5.0-10.0 cm. If the top layer was not flat, the lower part of the slope was used to define the 0-1 cm layer. Each layer

was cut with a slicing plate that was then rinsed into the bottle. The upper side of the slicing plate was used on the current layer, and the downside as the top side for the next layer. The top three layers were typically transferred into 500 mL UN certified bottles using a funnel. The 5-10 cm layer was carefully sliced into smaller pieces using a knife or a spatula and placed directly into a 1500 mL UN certified bottle. This approach was also employed with the 3-5 cm layer when it was hard to pass through the funnel. Slicing rings, funnels, and knives (spatula) were rinsed into the appropriate bottle with filtered seawater. Each bottle was labelled on the cap and one side, and a paper label was placed inside the bottle. Samples were preserved in 4% buffered formaldehyde ( $\frac{1}{2}$  8% formaldehyde with borax [20 g L<sup>-1</sup> 40% formaldehyde],  $\frac{1}{2}$  sediment / filtered seawater). If the sample filled more than half the volume of a bottle, the overlying water was passed through the sieve and the material was washed back into the bottle to ensure the correct final formaldehyde concentration.

**eDNA (NOC-DST-OBE):** One large core (100 mm ID) was used. All slicing equipment (i.e. slicing plate, slicing rings, and spatula) was sterilised in bleach or autoclaved prior to sample processing, and washed with Milli-Q before each slice. Nitrile gloves were worn at all stages (a new pair per core tube). The overlying water was discarded by pulling the core tube down the plunger, and the following horizons were sliced: 0.0-1.0, 1.0-2.0, 3.0-4.0, 4.0-5.0, 5.0-6.0, 6.0-7.0, 7.0-8.0, 8.0-9.0, 9.0-10.0, 10.0-12.0, 14.0-16.0, and 20.0-22.0. Note a 2.0-3.0 cm layer was processed from station JC165-26 only. For each slice, samples of sediment were placed in Whirlpack bags and stored in a -80°C freezer. In all cases, sediment near the edge of the core was discarded. Further detail is provided in the molecular genetics section.

**Biogeochemistry (ULIV, Dr R. Jeffreys):** Large core tubes (100 mm ID) were used to collect sediment samples for biochemistry analyses. The overlying water was siphoned from the top of the sediment and discarded. Any phytodetritus on the sediment surface was carefully collected with a pipette and placed into a foil lined Petri dish. The sediment was then sliced with a metal slicing plate at 0.5 cm intervals to 2 cm. Sediment in contact with the core tube was removed using a metal knife and the remaining sediment was transferred to the foil lined Petri dishes. The top of each sample was immediately covered with muffled foil before placing the Petri dish lid on top. Each Petri dish was labelled with the cruise number (JC165), station number, date and sample horizon using provided adhesive labels, which were secured with Sellotape. Samples from each core were placed in labelled plastic bags and immediately frozen at -80°C. Nitrile gloves were worn at all stages. Before processing and between slices the slicing equipment (siphon, pipette, slicing ring, slicing plate, metal knife) were thoroughly rinsed with filtered seawater. Only visibly intact cores with an undisturbed sediment surface and no cracks or pockets of water in the sediment were selected for sediment sampling. In total, eight cores from the PAP Central coring area were sampled for biochemistry analyses.

*Summary of sediment samples retained for biochemistry analysis.*

Stn number	Date	Latitude (N)	Longitude (W)	Depth (m)
JC165-010	24/05/2018	48° 50.469	16° 31.315	4841
JC165-011	25/05/2018	48° 50.487	16° 31.450	4841
JC165-016	26/05/2018	48° 50.199	16° 31.498	4844
JC165-018	26/05/2018	48° 50.366	16° 31.061	4842
JC165-026	28/05/2018	48° 50.289	16° 30.914	4844
JC165-029	28/05/2018	48° 50.205	16° 31.299	4842
JC165-033	29/05/2018	48° 50.358	16° 30.968	4841
JC165-034	30/05/2018	48° 50.339	16° 31.024	4841

**Metazoan meiofauna (NOC-DST-OBE):** A small core tube (59 mm ID) was used. The overlying top water was siphoned into a 250 µm sieve and transferred into a 500 mL UN certified bottle corresponding to the 0-5 cm sediment layer. Syringes were used to extract the small volume of remaining water if necessary. If the top layer was not flat, the lower part of the slope was used to define the layer. The slicing plate and the slicing ring were rinsed inside the bottle with filtered seawater. The bottle was labelled on the cap and one side, and a paper label was placed inside the bottle. The sample was preserved in 4% buffered formaldehyde (½ 8% formaldehyde with borax [20 g L<sup>-1</sup> 40% formaldehyde] ½ sediment / filtered seawater). If the sample filled more than half the volume of a bottle, the overlying water was passed through the sieve and the material was washed back into the bottle to ensure the correct final formaldehyde concentration.

**Microplastics (NOC-DST-OBE):** Large core tubes (100 mm ID) were used to retain samples for microplastics analysis. Upon removal from the Megacore, the core designated for microplastics analysis was immediately covered with ashed aluminium foil to avoid airborne contamination. After placing the core onto the extruder, the overlying surface water was siphoned through a 250 µm sieve and the sediment remaining on the sieve was transferred into a pre-numbered, ashed glass jar (250 ml or 500 ml), which was provided with muffled aluminium foil on top. The first 1 cm of the sediment was then cut with a metal slicing plate and added to the sampling jar. A second horizon (10-11 cm) was sampled as control and transferred into a separate glass jar. After placing the sample into the jar, the jar was immediately covered with the ashed foil. The jars were closed with plastic lids after both horizons had been sampled. Before processing and between slicing all slicing equipment (slicing ring, metal plate and knife) was washed with filtered seawater. Sampling jars and lids were labelled with cruise number (JC165), station number, date, and sample horizon. Samples were dried on board in the oven at 45-48°C with the lid and ashed foil slightly open. After drying, each jar was placed into a paper bag and stored in provided sampling crates. Samples that could not be immediately dried were placed in paper bags



and stored in the cold room until space in the oven became available. Only visibly intact cores with no cracks or pockets of water in the sediment were selected for microplastics sampling. Any anomalies noted during slicing were recorded in the sample log sheet. A summary of the sediment cores collected for microplastic analysis is given in Table 2.

*Summary of sediment cores retained for microplastics analysis.*

Station	Date	Site	Latitude (N)	Longitude (W)	Depth (m)
JC165-007	23/05/2018	PAP Central	48° 50.391	16° 31.293	4842
JC165-008	24/05/2018	PAP Central	48° 50.321	16° 31.408	4841
JC165-016	26/05/2018	PAP Central	48° 50.199	16° 31.498	4844
JC165-025	27/05/2018	PAP Central	48° 50.318	16° 31.228	4841
JC165-026	28/05/2018	PAP Central	48° 50.289	16° 30.914	4844
JC165-029	28/05/2018	PAP Central	48° 50.205	16° 31.299	4842
JC165-033	29/05/2018	PAP Central	48° 50.358	16° 30.968	4841
JC165-037	30/05/2018	PAP Central	48° 50.164	16° 31.297	4841
JC165-039	31/05/2018	AESA Hill H3	48° 58.959	16° 33.066	4777
JC165-040	01/06/2018	AESA Hill H3	48° 59.029	16° 33.007	4782
JC165-051	03/06/2018	AESA Hill H3	48° 58.914	16° 33.131	4777
JC165-053	03/06/2018	AESA Hill H3	48° 58.902	16° 33.352	4790



*Glass jars with dried sediment samples for microplastics analysis.*

**Prokaryotic and viral dynamics (UNIVPM):** During this cruise, UNIVPM aimed to collect sediment samples at the PAP Central site investigated during the BENGAL project (1996-1999) to compare sediment variables analysed 20 years ago. We will investigate prokaryotic and viral dynamics in relation to the trophic state of the system (organic matter analyses). We also aimed to collect some holothurian specimens to investigate organic matter digestion in different species (detailed in trawl report below).

Samples for microbiological and organic matter analyses were collected by using a Megacore. For each deployment, a minimum of one large core (100 mm ID) was used by UNIVPM team. Sixteen cores were collected and processed as detailed below from the PAP Central site. In addition, 11 cores were processed from the AESA hill H3 sampling area. Upon recovery each core was vertically sliced into nine layers: 0-0.5, 0.5-1.0, 1.0-2.0, 2.0-3.0, 3.0-4.0, 4.0-5.0, 5.0-6.0, 6.0-10.0, and 10.0-15.0 cm. All slicing equipment was sterilised prior to sample processing and washed with Milli-Q between each slice. Nitrile gloves were worn at all stages. For each layer, aliquots were collected and stored (-20°C) for subsequent analysis of organic matter, viral and prokaryotic abundance. An aliquot of sediment from 0-1 cm layer was also stored in 1% formaldehyde (final concentration) for additional analysis of prokaryotic abundance. Incubations of sediment samples at 4°C temperature for viral production was conducted on the top sediment layer (0-1 cm) at all stations. To process the cores the overlying top water was collected and pre-filtered on 0.02 µm filter. In addition, 15 additional sediment cores were collected (at Stations: JC165-04, 05, 08, 10, 16, 18, 29, 33, 34, 37, 57, 59, 66, 67, 71), sliced as detailed above (with the only exception of the extra cores collected at -04 and -05, which were sliced into 5 layers: 0-1cm, 1.3cm, 3-5cm, 5-10cm, 10-15cm) and immediately frozen at -20°C.

*Summary of the Megacorer processing protocols.*

	<b>Macrofauna</b>	<b>Metazoan meiofauna</b>	<b>Microplastics</b>	<b>Biogeo-chemistry</b>	<b>eDNA</b>	<b>Prokaryotes</b>		
<b>Cores per deployment</b>	Min. 4 [a]	1	1	1	1			
<b>Preservation</b>	4% bF	4% bF	Dried at c. 45°C	-80°C	RNA Later, -80°C	-20°C		
<b>Supernatant</b>	250 µm sieve, added to first layer	250 µm sieve, added to first layer	Discarded	Discarded	Discarded	1 sample per station filtered for control		
				0.0-0.5		0.0-0.5		
				0.5-1.0		0.5-1.0		
				1.0-1.5				
				1.5-2.0				
							[b]	2-3
							3-4	3-4
							4-5	4-5
							5-6	5-6
							6-7	
							7-8	
							8-9	
							9-10	
						10-11		



					20-22	
--	--	--	--	--	-------	--

<sup>a</sup> <4 core tubes on four occasions to provide at least one core for eDNA and prokaryotic analyses.

<sup>b</sup> only from station JC165-26.

\* 4% bF, 4% borax buffered [20 g L<sup>-1</sup> 40% formaldehyde] formaldehyde seawater solution.

**Opportunistic specimens (NOC-DST-OBE):** Larger macrofaunal organisms (e.g. Table below), mainly found on top of the cores, were carefully extracted with tweezers and preserved with 4% buffered formaldehyde (½ 8% formaldehyde with borax [20 g l-1 40% formaldehyde] ½ sediment / filtered seawater), ethanol, or left to dry at room temperature (i.e. xenophyophore). All samples were labelled with cruise number (JC165), Station number, date, sediment horizon, analysis type, and preservation method. The outside of every container was labelled (top and side) and a paper label was placed inside the container.

*List of opportunistic specimens.*

Station	Specimen	Section (cm)	Preservation
JC165-11	Xenophyophore Polychaete tube Gelatinous blob.	0-1	4% bF
JC165-18	Unknown specimen resembling an olive pit (shape, colour)	4-6	ethanol
JC165-29	Xenophyophore	0-1	dried at room temperature
JC165-34	Ascidian	0-1	4% bF
JC165-57	Plate-like xenophyophore	0-1	dried at room temperature
JC165-63	Sponge glass (?) and encrusting foraminifera (?) on a dropstone.	0-1	4% bf
ME108-678	Coral polyps.		4% bF
ME108-678	Coral polyps.		ethanol
JC165-66	Tubular soft sponge	0-1	4% bF
JC165-67	Polychaete	2-3	4% bF
JC165-67	Tubular soft sponge Polychaete tube Unknown specimen	0-1	4% bF
JC165-71	Tubeworm (corresponding tube preserved separately in ethanol)	0-1	-80°C
JC165-71	Tubeworm (corresponding worm preserved at - 80°C)	0-1	ethanol
JC165-72	Xenophyophore	0-5	dried at room temperature



Examples of the opportunistically collected material.

**Otter trawl.** The NMFSS-supplied OTSB14 (semi-balloon otter trawl, 14 m headrope) was rigged and fished in conventional fashion. Note, as per RRS *Discovery* cruise 077, this net appears to be a slight variant on the original pattern, having a different codend closure (no sewn in rings) and lazy decky attachment (strangling rings, not sewn in netting strop). No particular problems were encountered during launch, fishing, or recovery phases of the operations, track of the first station (JC165-064) required a cautious short fish to avoid any possibility of encroaching on the 2-nm safety zone around the southern cable.

*Summary of otter trawl station metadata.*

Station JC165-	Date 2018	Seabed start position		Seabed end position		Depth (m)	Dist. fished (km)
064	06/06	48° 58.201' N	016° 53.297' W	48° 55.316' N	016° 49.452' W	4839	7.1
074	09/06	48° 50.728' N	016° 54.518' W	48° 55.629' N	016° 53.299' W	4843	9.2

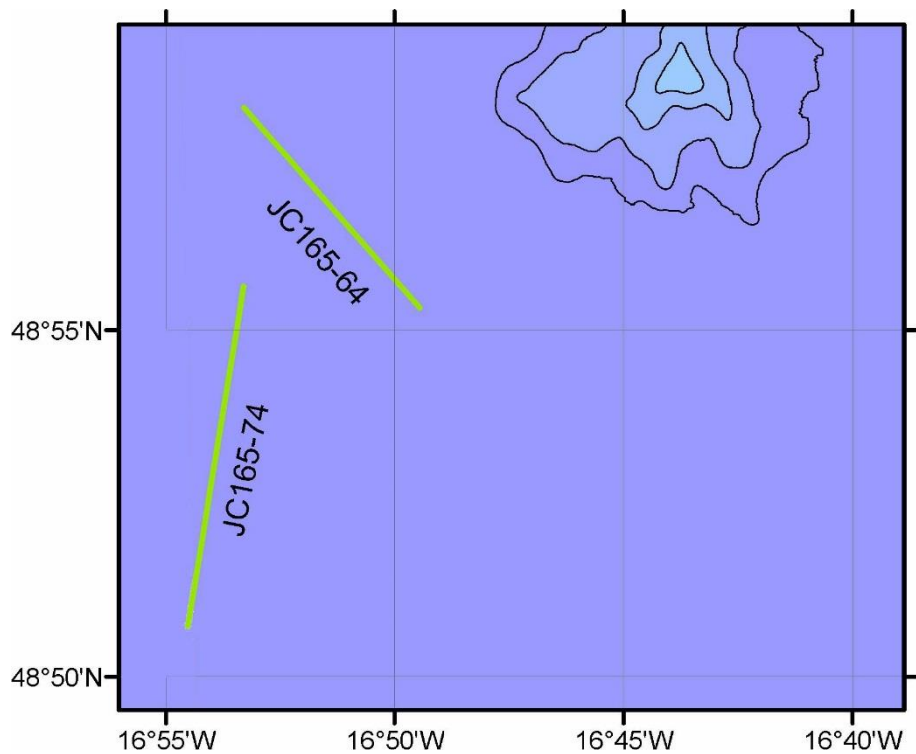

Approximate seabed tracks fished by the two otter trawls.

**Trawl sample processing:** The trawl catch was spilled directly into four crates that were placed beneath the net prior to opening. Megafaunal specimens and clinker were distributed in several other crates, buckets, and trays, and brought to the sieving table where they were washed with filtered seawater and sorted to broad taxonomic group. The net was then examined in detail and a large number of specimens, notably pycnogonids, polychaetes (*Laetmonice* spp.), and small actinarians (*Iosactis vagabunda*) were returned to the catch. Gloves were used during the washing to avoid injury with glass and clinker. Specimens were gently washed on the sieving table and brought to the 4°C controlled-temperature room. Subsets of intact specimens were selected for biogeochemistry (Dr R. Jeffreys, ULIV), molecular (UNIVPM), and gut content analysis (NOC-DST-OBE). Overall, UNIVPM retained 26 specimens of holothurian: 14 individuals belonging to *Amperima rosea* (7 from each trawl) and 12 to *Molpadiodemus* (6 from each trawl). Photographs, length measurements, and wet weights were taken of each individual. All specimens were preserved frozen in RNA later. Further details are provided in the NOC-DST-OBE molecular genetics section. Individual fresh wet weight (g) and standard linear body size dimension (cm) were recorded for each of these selected specimens. Example, intact, specimens were photographed for future morphological reference. The rest of the catch was put aside for preservation as soon as possible to ensure the best quality for future morphological identification.

Actinarians attached to tubeworms, glass sponges, clinker, or litter (e.g. glass bottle), and parasitic actinarians or gastropods found on holothurians (*Paroriza* sp., *Oneirophanta* sp.) were not detached to prevent any morphological damage, and example associations were photographed in the lab. Clinker free of specimens, litter, and other human artefacts caught were put aside and photographed for the record. Good quality crustaceans (intact specimens, not too damaged) were preserved in 100% ethanol, while damaged crustaceans and other taxa were preserved in 4% borax buffered [20 g L<sup>-1</sup> 40% formaldehyde] formaldehyde seawater solution. All samples were labelled with cruise number (JC165), Station number, Date, trawl type (OTSB14), taxon, and type of preservative. Each container was

labelled on the cap (except blue barrels that have a black cap) and one side, and a paper label was placed inside the container.

From both trawls, the catch was a fairly typical of megabenthic invertebrates from PAP. Holothurians such as *Psychropotes* and *Oneirophanta*, actinarians (*Amphiantus*, *Actinauge*), and asteroids (*Hyphalaster*, *Styracaster*) were the visual / volume dominants.



Examples images of artefacts and specimens caught during the two trawls.

Samples retained from trawls JC165-064 and JC165-074.

Station	Sample	Container	Preservation
JC165-064	sponge	1500 mL UN	4% formaldehyde
JC165-064	pycnogonida	1500 mL UN	4% formaldehyde
JC165-064	polychaetes	1500 mL UN	4% formaldehyde
JC165-064	tubes	1500 mL UN	4% formaldehyde
JC165-064	asteroids, ophiuroids	1500 mL UN	4% formaldehyde
JC165-064	mixed decapoda	1500 mL UN	4% formaldehyde
JC165-064	residual mic	500 mL UN	4% formaldehyde
JC165-064	Molluscs	500 mL UN	4% formaldehyde
JC165-064	ophiuroida	500 mL UN	4% formaldehyde
JC165-064	anemones, <i>Iosactis</i>	500 mL UN	4% formaldehyde
JC165-064	parasitic anemones	500 mL UN	4% formaldehyde
JC165-064	holothurian	500 mL UN	4% formaldehyde
JC165-064	<i>Psychropotes</i>	blue barrel	4% formaldehyde
JC165-064	anemones on clinker, glass sponge, <i>Umbellula</i> , squid	L	4% formaldehyde
JC165-064	<i>Molpadiodemas</i>	M	4% formaldehyde
JC165-064	<i>Oneirophanta</i>	S	4% formaldehyde
JC165-064	Fish	S	4% formaldehyde
JC165-064	<i>Paroriza</i>	S	4% formaldehyde
JC165-064	Sea stars	XS	4% formaldehyde
JC165-064	<i>Actinauge</i> , <i>Amphiantus</i>	XS	4% formaldehyde
JC165-064	jelly fish	XS	4% formaldehyde
JC165-064	various	XS	4% formaldehyde
JC165-064	salps	XS	4% formaldehyde
JC165-064	mixed crustacea	1500 mL UN	ETOH
JC165-064	squat lobster ( <i>M. crassa</i> )	1500 mL UN	ETOH
JC165-064	19 × <i>Psychropotes</i>	zipped bag	frozen -80°C for ULIV
JC165-064	24 × <i>Molpadiodemas</i>	zipped bag	frozen -80°C for ULIV
JC165-064	6 × <i>Iosactis</i>	zipped bag	frozen -80°C for ULIV
JC165-064	7 × <i>Hyphalaster</i>	zipped bag	frozen -80°C for ULIV
JC165-064	4 × <i>Amperima</i>	zipped bag	frozen -80°C for ULIV
JC165-064	12 × <i>Oneirophanta</i>	zipped bag	frozen -80°C for ULIV
JC165-064	7 × <i>Amperima</i>	60 mL jar	frozen for UNIVPM
JC165-064	3 × <i>Molpadiodemas</i>	500 mL UN	frozen for UNIVPM
JC165-064	1 × <i>Molpadiodemas</i>	120 mL jar	frozen for UNIVPM
JC165-064	2 × <i>Molpadiodemas</i>	60 mL jar	frozen for UNIVPM
JC165-064	8 × <i>Oneirophanta</i>		frozen for NOC-DST-OBE
JC165-064	11 × <i>Psychropotes</i>		frozen for NOC-DST-OBE
JC165-064	6 × <i>Molpadiodemas</i>		frozen for NOC-DST-OBE
JC165-064	6 × <i>Paroriza</i>		frozen for NOC-DST-OBE
JC165-074	unknown limpet? Noe_2	14 mL vial	4% formaldehyde
JC165-074	unknown ascidian Noe_1	14 mL vial	4% formaldehyde
JC165-074	jelly fish & jelly-like	1500 mL UN	4% formaldehyde
JC165-074	octopus	1500 mL UN	4% formaldehyde
JC165-074	residual	1500 mL UN	4% formaldehyde
JC165-074	barnacle	1500 mL UN	4% formaldehyde
JC165-074	bivalves	1500 mL UN	4% formaldehyde
JC165-074	mix holothurians	1500 mL UN	4% formaldehyde
JC165-074	salps	1500 mL UN	4% formaldehyde
JC165-074	worms	1500 mL UN	4% formaldehyde
JC165-074	2 × <i>Deima</i> , 1 holothurian	1500 mL UN	4% formaldehyde
JC165-074	blob	1500 mL UN	4% formaldehyde
JC165-074	glass sponge	1500 mL UN	4% formaldehyde
JC165-074	corals unattached	1500 mL UN	4% formaldehyde

Station	Sample	Container	Preservation
JC165-074	tubes	1500 mL UN	4% formaldehyde
JC165-074	<i>Amperima rosea</i>	1500 mL UN	4% formaldehyde
JC165-074	cnidaria Noe_3	50 mL vial	4% formaldehyde
JC165-074	mix	500 mL UN	4% formaldehyde
JC165-074	<i>Iosactis</i>	500 mL UN	4% formaldehyde
JC165-074	anemones on clinker	blue barrel	4% formaldehyde
JC165-074	Fish	blue barrel	4% formaldehyde
JC165-074	2 × <i>Psychropotes</i>	blue barrel	4% formaldehyde
JC165-074	clinker with organisms	blue barrel	4% formaldehyde
JC165-074	<i>Molpadiodemas</i>	L	4% formaldehyde
JC165-074	mixed anemones	L	4% formaldehyde
JC165-074	wood	L	4% formaldehyde
JC165-074	<i>Oneirophanta</i>	M	4% formaldehyde
JC165-074	<i>Molpadiodemas</i>	M	4% formaldehyde
JC165-074	<i>Paroriza</i>	S	4% formaldehyde
JC165-074	<i>Hyphalaster</i>	S	4% formaldehyde
JC165-074	<i>Dytaster</i>	S	4% formaldehyde
JC165-074	<i>Pseudostichopus</i>	XS	4% formaldehyde
JC165-074	<i>Styracaster</i>	XS	4% formaldehyde
JC165-074	sea spiders	1500 mL UN	ETOH
JC165-074	squat lobster	1500 mL UN	ETOH
JC165-074	shrimps	1500 mL UN	ETOH
JC165-074	Polychellidae	1500 mL UN	ETOH
JC165-074	ophiuroids + brisingids (for Tim O'Harra)	1500 mL UN	ETOH
JC165-074	pteropod (for Corinne NOC)	50 mL vial	ETOH
JC165-074	3 × <i>Molpadiodemas</i>	120 mL jar	frozen for UNIVPM
JC165-074	3 × <i>Molpadiodemas</i>	500 mL UN	frozen for UNIVPM
JC165-074	7 × <i>Amperima</i>	60 mL jar	frozen for UNIVPM
JC165-074	2 × <i>Amperima</i>		frozen for NOC-DST-OBE
JC165-074	1 × <i>Deima</i>		frozen for NOC-DST-OBE
JC165-074	5 × <i>Psychropotes</i>		frozen for NOC-DST-OBE
JC165-074	3 × <i>Molpadia blakei</i>		frozen for NOC-DST-OBE
JC165-074	7 × <i>Molpadiodemas</i>		frozen for NOC-DST-OBE
JC165-074	7 × <i>Paroriza</i>		frozen for NOC-DST-OBE
JC165-074	2 × <i>Pseudostichopus</i>		frozen for NOC-DST-OBE

## Molecular Ecology Sampling

Rob Young and Anita Hollingsworth

The Molecular Ecology group collected water samples from the CTD rosettes, sediment, water, and macrofauna samples from the Megacore, and specimens from the two trawls. A total of 554 samples were taken for molecular analysis, including 225 samples from the Megacores (including top water and megafauna), 82 samples from the CTD rosettes, and 247 from the two trawls. These samples are summarized in tables 1-3. All water samples were filtered through Sterivex 0.22 µm filters using either sterile syringes or peristaltic pump systems. Pump systems and water bottles were bleach sterilized and washed with MilliQ water between sample sets. Water samples were either frozen immediately at -80°C or fixed in RNALater (left to sit overnight at 4°C) and frozen at -80°C. RNALater was removed from the filter before freezing. Megacore samples were sliced into the following horizons unless otherwise

noted: 0-1, 1-2, 3-4, 4-5, 5-6, 10-12, 14-16, and 20-22 cm. Bleach sterilized slicers, rings and spatulas were used in slicing. Some top water was filtered by UNIVPM to use for viral incubations. These filters were retained and immediately frozen at -80°C. Several macrofauna samples were collected for DNA analysis from the top of Megacores.

A primary objective of the Molecular Ecology group on JC165 was to add to the collection of holothurian microbiome samples (gut contents) collected on two previous cruises, DY050 and DY077, targeting species across the feeding guilds described by D.SM. Billett (NOC-DST-OBE). On this cruise, we collected 18 individuals from 3 species in feeding group B (*Deima validum*, n=1 *Oneirophanta mutabilis* n = 6, and *Psychropotes longicauda*, n = 11), and 21 individuals from 4 species in group C (*Molpadia blakei*, n = 3; *Molpadioides villosus*, n = 5; *Paroriza prouhoi*, n = 11 and *Pseudostichopus aemulatus*, n = 2). We also collected two individuals from group A (*Amperima* sp.). Individual holothurians were dissected on board, and gut contents and host tissue were collected. Unless otherwise noted, replicate samples of gut contents were collected from the anterior and posterior of the gut and were both frozen at -80°C as well as preserved in RNALater; host tissue was frozen at -80°C. Gut contents, where possible, were collected using a sterile syringe. When not possible to collect by syringe, guts were opened with a scalpel, and a spatula was used to extract contents. Only animals with intact guts were targeted for microbiome sampling. Occasionally, an individual was included in the sampled set with a broken gut if the tear was sufficiently far from the area sampled and we could determine that the sample taken was of good quality. Host tissue from the body wall was taken from every individual and frozen at -80°C. Upon dissection, if the gut was broken and the gut sample was deemed to be of poor quality, only host tissue was taken. A total of 57 host tissue samples were taken across the 8 species targeted, with 41 of those corresponding to the microbiome samples described above. Additional host samples taken include 2 individuals of *O. mutabilis*, 5 of *P. longicauda*, 8 of *M. villosus*, and 2 of *P. prouhoi*. All individuals were weighed and measured, and photos were taken with labels corresponding to numbers as tabulated below. Two parasitic snails (Eulimidae, unknown sp.) were removed from hosts and preserved in ethanol.

*Summary of all samples taken for Molecular Ecology.*

<b>Station</b>	<b>Gear</b>	<b>Comments</b>	<b>Samples</b>
JC165-004	Megacore	Large horizontal burrow at 4-5 cm	17
JC165-005	Megacore	Top 1 cm had lots of small burrows; top water filtered	9
JC165-006	CTD	4830m, 4800m, 4750m, 4000m, 850m, 750m, 400m, 20m	8
JC165-007	Megacore	4-5 cm layer had small burrows; top water filtered	9
JC165-008	Megacore	Burrows in 0-1 and 1-2 cm layer	8
JC165-010	Megacore	Top 1 cm disturbed. Burrows throughout. Potential human contamination on instruments	8
JC165-011	Megacore	10-12cm more mousse-like in consistency	8
JC165-014	CTD	4828, 4800, 4750, 4000, 2000, 925, 750, 70m. Replicates of 500 ml, 1.5 L and 3 L	23
JC165-015	Megacore	All cores cracked so none were used for eDNA	0
JC165-016	Megacore	Top water filtered	9
JC165-018	Megacore	Burrows in top 1cm layer	8
JC165-019	Megacore	Sediment very sloppy and mousse-like throughout core	8
JC165-023	CTD	100 m	1
JC165-024	CTD	2000, 950, 750, 125m	4
JC165-025	Megacore	Top water filtered	9
JC165-026	Megacore	Dark grey patch running through core. Sampled every cm to 10cm. 4-5cm sample in RNALater	13
JC165-029	Megacore	Significant delays during deployment. Took 8 hours.	8
JC165-032	CTD	4838, 4800, 4750, 4000, 1800, 850, 625, 250m. Replicates of 500ml, 1.5L and 3L	23
JC165-033	Megacore	Core cracked at 10 cm; was the last horizon sampled; top water filtered (Laura's core, not eDNA core)	7
JC165-034	Megacore	Most cores were cracked but eDNA core stayed intact	8
JC165-037	Megacore		8
JC165-039	Megacore	Foram on top of sediment, burrows in 10-12 and 14-16 cm layers. Hill band C. Deployed with 5 cups.	8
JC165-040	Megacore	Short core only to 14-16 cm - burrow in this last layer. Maybe clinker on top. Top water filtered.	8
JC165-046	CTD	4830, 4800, 4750, 4000, 2000, 850, 625, 250 m	23
JC165-047	Megacore	All cores failed	0
JC165-051	Megacore	Short core only to 14-16 cm. 3-4 cm layer accidently discarded	6
JC165-053	Megacore	Short core only to 14-16 cm - horizontal burrow in 5-6 cm layer	6
JC165-057	Megacore	Full core. Clinker (n=3) in 2-3 and 3-4 cm layer in separate whirlpak	9
JC165-059	Megacore	Full core.	8
JC165-063	Megacore		8
JC165-064	Trawl	See Table 2.	88
JC165-066	Megacore	3-6cm clinker or rock in layer, in separate whirlpak	9
JC165-067	Megacore		8
JC165-071	Megacore	tubeworm frozen whole; 3 1.5ml tubes: forams	12
JC165-072	Megacore	holothurian poop	6
JC165-074	Trawl	See Table 3.	159



Samples collected from trawl JC165-064.

<b>ID</b>	<b>Species</b>	<b>Comments</b>	<b>Samples</b>
Holo-1	<i>O. mutabilis</i>	Full samples taken	5
Holo-2	<i>O. mutabilis</i>	Full samples taken	5
Holo-3	<i>O. mutabilis</i>	Full samples taken	5
Holo-4	<i>O. mutabilis</i>	Ruptured. No samples taken.	0
Holo-5	<i>O. mutabilis</i>	Full samples taken but put in Holo-4 tubes. 2 x RNA Later anterior gut.	6
Holo-6	<i>O. mutabilis</i>	Ruptured. Host tissues only	1
Holo-7	<i>P. longicauda</i>	Full samples taken. 2 x RNALater tubes of anterior gut	6
Holo-8	<i>P. longicauda</i>	Full samples taken	5
Holo-9	<i>P. longicauda</i>	Ruptured. Host tissues only	1
Holo-10	<i>P. longicauda</i>	Ruptured. Host tissues only	1
Holo-11	<i>P. longicauda</i>	Ruptured. Host tissues only	1
Holo-12	<i>P. longicauda</i>	Full samples taken	5
Holo-13	<i>M. villosus</i>	Gut ruptured but all samples taken excluding post. RNALater	4
Holo-14	<i>M. villosus</i>	Ruptured. Host tissues only	1
Holo-15	<i>M. villosus</i>	Full samples taken; Posterior RNALater taken w/ spatula	5
Holo-16	<i>M. villosus</i>	Ruptured. Host tissues only	1
Holo-17	<i>M. villosus</i>	Ruptured. Host tissues only	1
Holo-18	<i>M. villosus</i>	Ruptured. Host tissues only	1
Holo-19	<i>P. prouhoi</i>	Ruptured (anterior only) but took all samples	5
Holo-20	<i>P. prouhoi</i>	Ruptured. Host tissues only	1
Holo-21	<i>P. prouhoi</i>	Full samples taken	5
Holo-22	<i>P. prouhoi</i>	Ruptured. Host tissues only	1
Holo-23	<i>P. prouhoi</i>	Full samples taken	5
Holo-24	<i>P. prouhoi</i>	Ruptured (anterior only) but took all samples	5
Holo-25	<i>O. mutabilis</i>	Full samples taken; posterior RNALater taken a bit up the gut towards the anterior	5
Holo-26	<i>O. mutabilis</i>	Full samples taken	5
Snail-1	<i>Eulimidae</i>	<i>O. mutabilis</i> holo-26 host	1
Snail-2	<i>Eulimidae</i>	<i>O. mutabilis</i> holo-25 host	1

Samples collected from trawl JC165-074.

ID	Species	Comments	Samples
Holo-27	<i>P. longicauda</i>	Ruptured. Host tissues only	1
Holo-28	<i>M. blakei</i>	Broken gut but good sample from ant. And post. All taken	5
Holo-29	<i>P. longicauda</i>	Full samples taken. Only fluid in posterior gut - coelomic fluid?	5
Holo-30	<i>P. longicauda</i>	Ruptured. Host tissues only	1
Holo-31	<i>P. longicauda</i>	Full samples taken.	5
Holo-32	<i>P. longicauda</i>	Full samples taken.	5
Holo-33	<i>P. longicauda</i>	Full samples taken.	5
Holo-34	<i>P. longicauda</i>	RNA Later to sample might be low	5
Holo-35	<i>P. longicauda</i>	Full samples taken.	5
Holo-36	<i>P. longicauda</i>	7 gut dissections (pictures of location): A1-A3, M (mid gut), P1-P3.	15
Holo-37	<i>P. aemulatus</i>	Anterior RNA Later sample slightly more anterior than frozen sample; potential coelomic fluid. Anterior frozen taken a bit more to the posterior than RNA Later sample, but no cont.	5
Holo-38	<i>P. aemulatus</i>	Sample in RNA Later from anterior. No posterior sample. Not much material in the gut. Gut broken	2
Holo-39	<i>Amperima sp.</i>	host, whole gut frozen; attempted ant./post. dissection, but couldn't get good dissection. Took contents that leaked, froze at -80	3
Holo-40	<i>M. villosus</i>	Full samples taken.	5
Holo-41	<i>M. villosus</i>	Ruptured. Host tissues only	1
Holo-42	<i>M. villosus</i>	Ruptured. Host tissues only	1
Holo-43	<i>M. villosus</i>	Full samples taken.	5
Holo-44	<i>M. villosus</i>	Ruptured. Host tissues only	1
Holo-45	<i>M. villosus</i>	Ruptured. Host tissues only	1
Holo-46	<i>M. villosus</i>	Oesophagus ruptured but rest of gut intact so full samples taken	5
Holo-47	<i>Amperima sp.</i>	Very little material in gut. Dissected whole gut out and preserved in RNA Later.	2
Holo-48	<i>P. prouhoi</i>	Full samples taken.	5
Holo-49	<i>P. prouhoi</i>	Full samples taken.	5
Holo-50	<i>P. prouhoi</i>	Full samples taken.	5
Holo-51	<i>P. prouhoi</i>	Full samples taken.	5
Holo-52	<i>P. prouhoi</i>	Juvenile? Full samples taken	5
Holo-53	<i>P. prouhoi</i>	Full samples taken.	5
Holo-54	<i>P. prouhoi</i>	Juvenile? Full samples taken.	5
Holo-55	<i>M. blakei</i>	5 gut dissections (pictures of location): A1, A2, M, P2, P1.	11
Holo-56	<i>M. blakei</i>	7 gut dissections (pictures of location): A1-A3, M, P1-P3.	15
Holo-57	<i>D. validum</i>	7 gut dissections (pictures of location): A1-A3, M, P1-P3.	15

**HyBIS operations.** The camera was set so the top of the frame orients to the compass heading. It was set to capture images every 5 seconds. Zoom was increased slightly not long after the transect start and left as the balance between illumination, blur and effective pixel dimension was not yet clear with one light missing. During the first dive descent, one of the seafloor illumination lights went out, as did the upward looking camera, the pressure sensor and altimeter. The altitude was decreased iteratively throughout the deployment as the true altitude was unknown. The HyBIS system tracked the ship 100-400 to the NW for moving from WP1 to WP2. Given the layback we overshot WP2 by 200 m and then

moved to WP3 and then WP4 with the HyBIS system tracking roughly the WP2 and 3 and on to 4, albeit off by ~100+ m to the WNW. The seafloor was generally free of phytodetritus. Various typical megafauna were seen with *P. longicauda* being fairly abundant. A trawl mark was observed in both N-S oriented lines. A total of nine dives were achieved with the system covering the four dives in the PAP Central area, three in AESA H3 hill area of the northern most fine scale grid surveyed during DY377/378 in 2012, one dive going down slope from the fine scale grid, and one near the summit of the seamount known to us as "Ben Billett" (D.S.M. Billett; NOC\_DST-OBE).

*Super Scorpio camera performance*

Station number JC165-	HyBIS dive number	Focal length (mm)	Shots $\geq 1/60^{\text{th}}$ (%)	Shots $\leq 1/100^{\text{th}}$ (%)
09	18	6.2 (3.8)	0.7	99.3
17	19	4.8	3.3	96.7
28	21	5.9	2.5	97.5
35	22	6.6 (5.7)	11.7	88.3
38	23	6.8	16.1	83.9
52	24	6.2 (5.1)	1.6	98.4
65	25	7.8	54.8	45.2
73	26	6.8	10.9	89.1
75	27	5.9 (4.5)	11.7	88.3

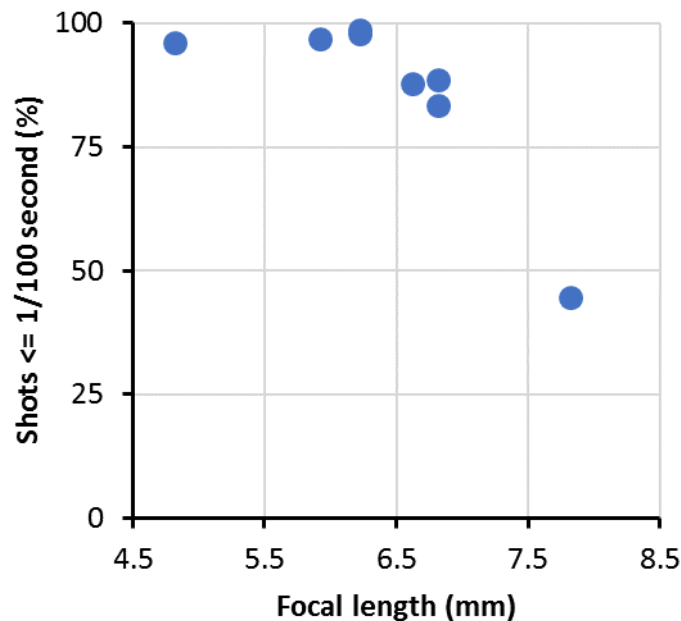

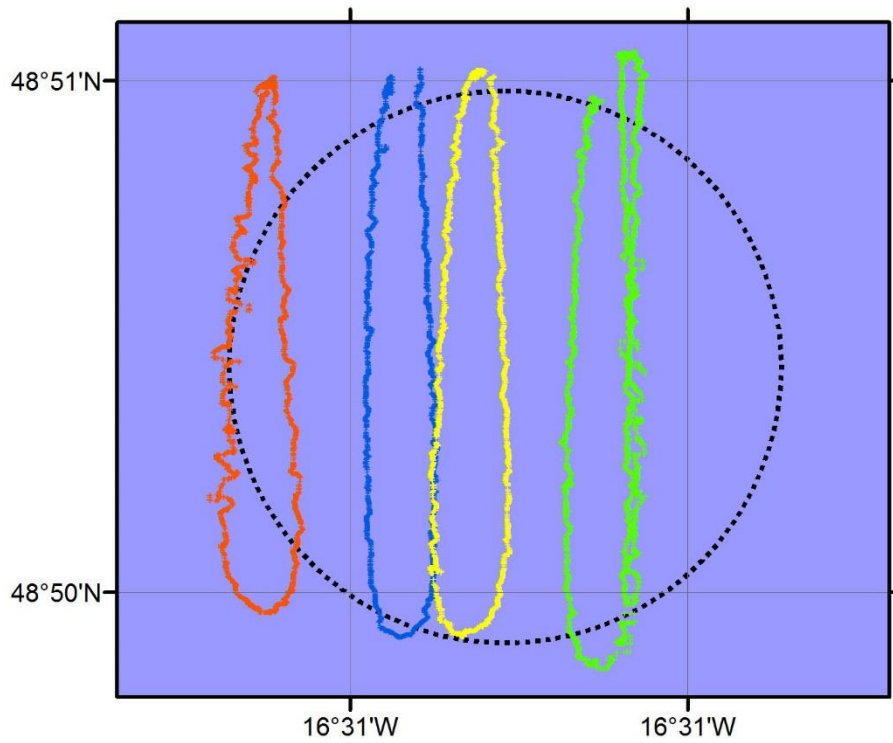

*HyBIS seafloor photography tracks achieved in the PAP Central area; dotted circle represents the 500 m radius random sampling area of the coring programme for reference (JC165-xx: red, 28; blue, 35; yellow, 09; green, 17).*

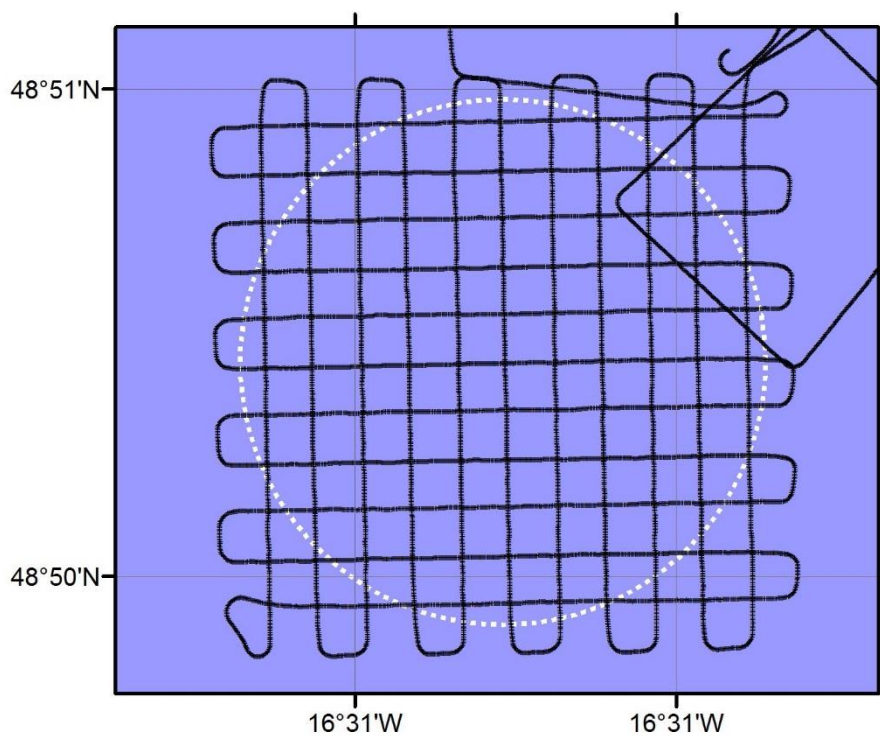

*For reference: Autosub6000 photographic survey lines of RRS Discovery cruise 377/8 in the PAP Central area (dotted circle 500 m of coring centre).*

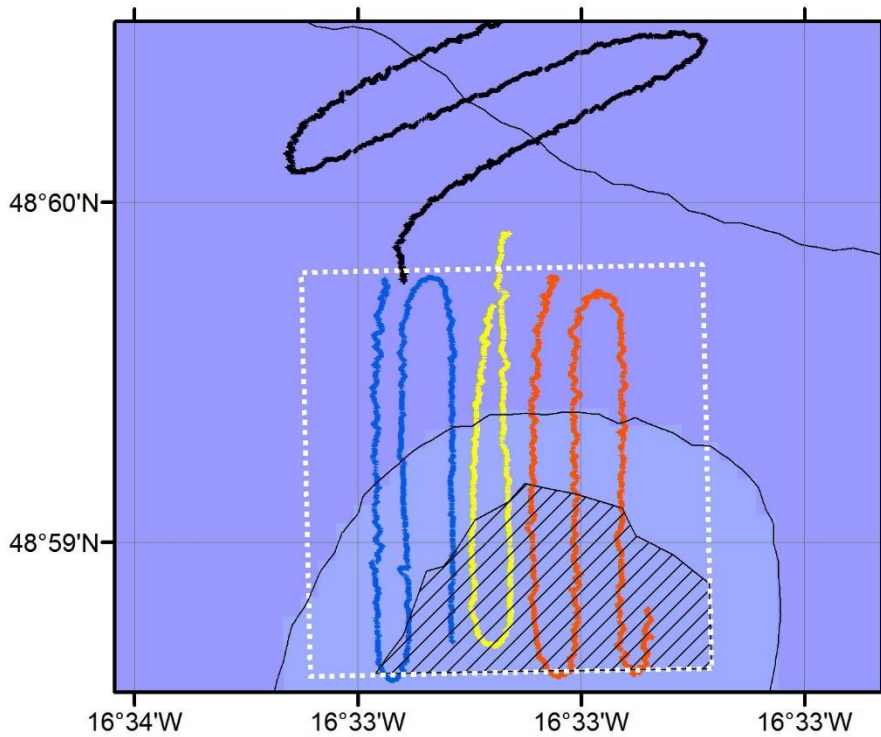

*HyBIS seafloor photography tracks achieved in the AESA hill H3 area; hatched region is the random core sampling area; dotted square represents the bounds of earlier Autosub6000 photographic survey, (JC165-xx: blue, 65; yellow, 38; red, 52). (Note black track is partial JC165-26).*

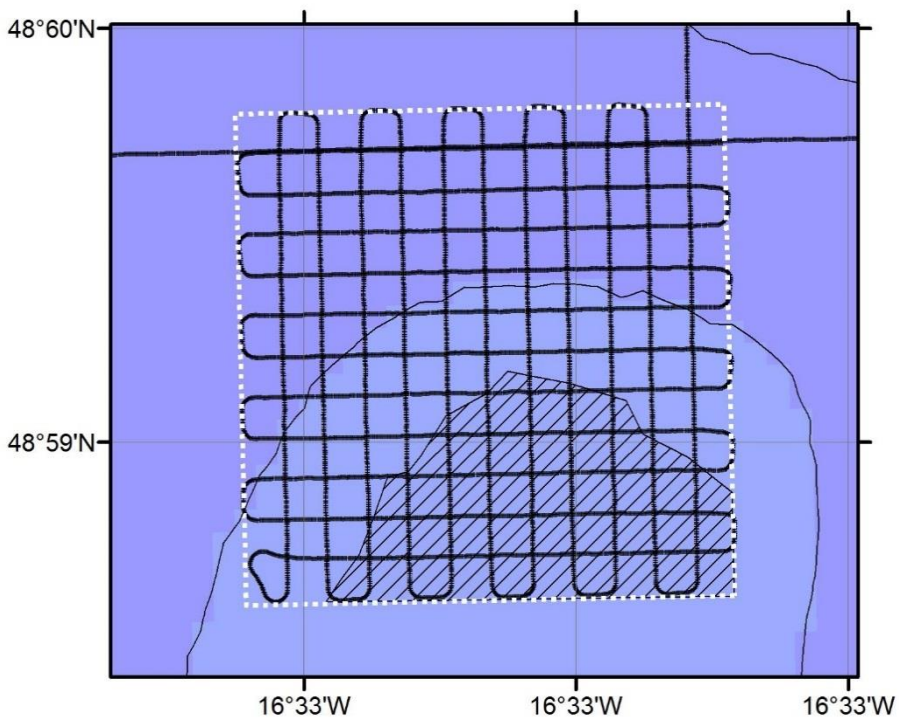

*For reference: Autosub6000 photographic survey lines of RRS Discovery cruise 377/8 in the AESA hill H3 area (hatched region is coring area).*

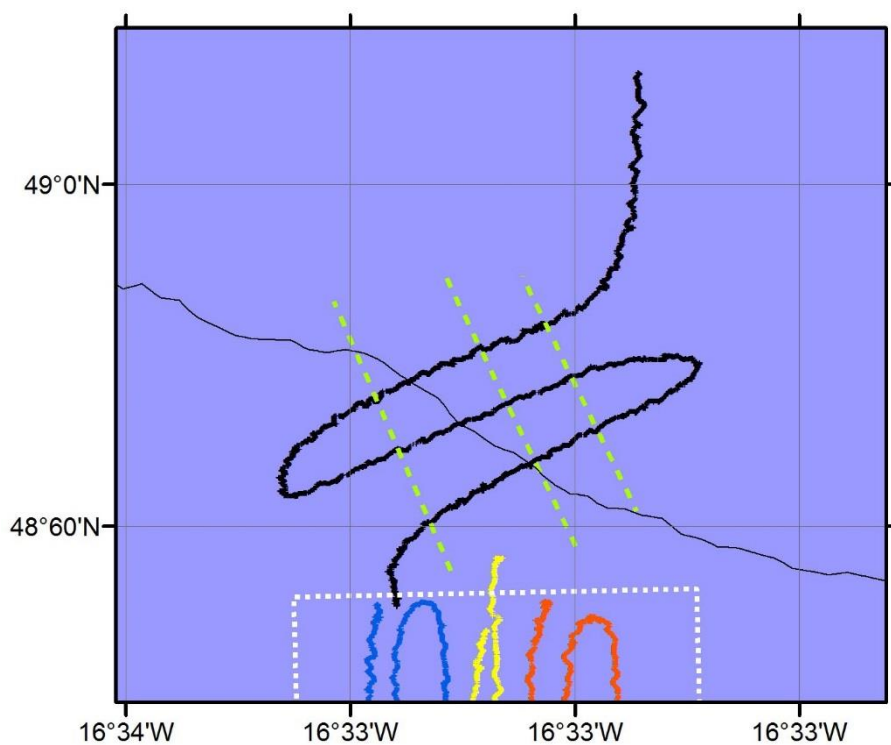

*HyBIS JC165-73 track (black) across three potential linear seafloor features (green dashed) noted during RRS Discovery cruise 377/8.*

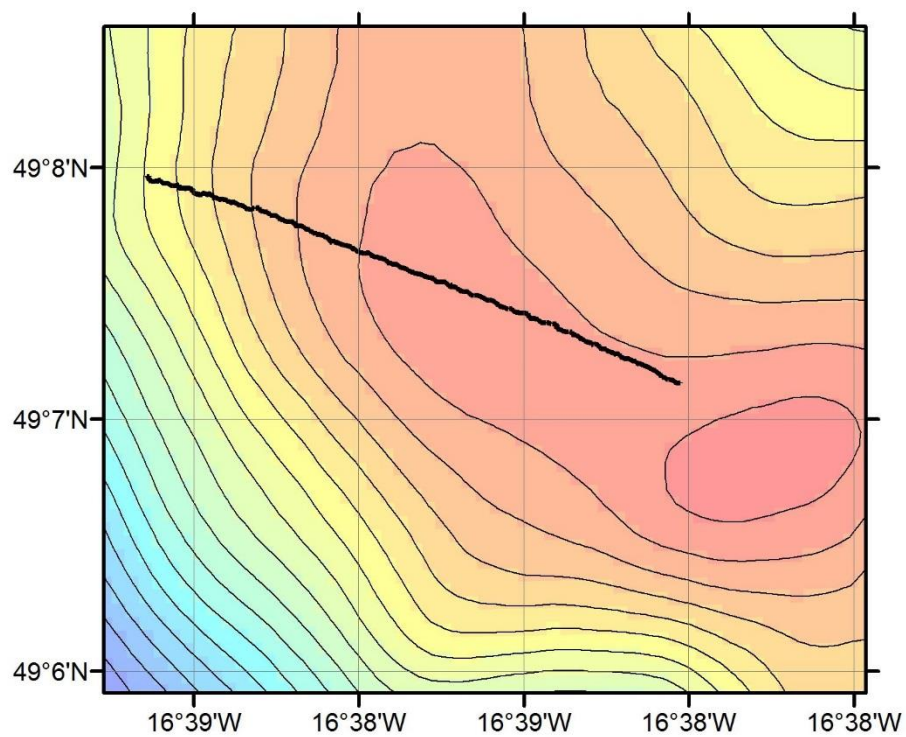

*HyBIS JC165-75 track (black) close to summit of "Ben Billett".*



## 15. FixO<sup>3</sup>-TNA project LO<sup>3</sup>CAted

Luciana Génio

During the JC165 cruise onboard RRS *James Cook*, I aimed to continue the work initiated under the scope of FixO<sup>3</sup>-TNA project LO<sup>3</sup>CAted (Larval Occurrences in Open Ocean: Connectivity studies in NE Atlantic and Mediterranean Sea), with the following specific objectives: **i)** recover larval traps and settlement frames from PAP#3 and Bathysnap moorings deployed during RRS *Discovery IV* cruise 077, and **ii)** deploy new devices in both moorings to continue time-series sampling. These objectives were mostly accomplished, except the recovery of samples from Bathysnap DY077-084 as detailed below.

### PAP3 new mooring deployment

Two sets of LO<sup>3</sup>CAted frames were inserted to the PAP#3 mooring deployed as station JC165-013 on 25/5/2018. Each set includes two settlement frames with experimental substrates, with the upper frame (shallower) having four passive larval tube traps attached on top (Fig. 1). All frames were clamped to a metal bar and inserted in line, one set under NORTEK AQD 2960 m and the other set under NORTEK AQD 4730 m. The experimental substrates were enclosed in a 2mm mesh net inside PVC containers with holes for flowing water. Wood (12 pieces of 2 x 2.5 x 8.5 cm natural pine wood per basket) and oyster shells (~20 valves per basket) were previously prepared in the laboratory at Aveiro University (Portugal). Wood was subjected to a heat shock (56°C for 30 min), and shells were brushed and washed with tap water, and dried at 60°C. Cow bones were bought in Southampton, frozen onboard, and placed inside four net baskets (~410 - 420g per basket). Experimental substrates (wood, bones and shells) were randomly ordered in each colonization frame. Final arrangement of substrates is shown below.



*LO<sup>3</sup>CAted upper settlement frame with larval tube traps on top (left), and lower frame (right) clamped into metal bar for in-line insertion in PAP#3 mooring.*

### *Experimental substrates order in each LO<sup>3</sup>CAted settlement frame*

Depth	Frame	Top	Middle	Bottom
	Upper	Wood	Shell	Bone
	Lower	Wood	Shell	Bone
	Upper	Bone	Wood	Shell
	Lower	Shell	Bone	Wood

Larval traps were filled with 20% Dimethyl sulfoxide saturated with NaCl (~50g per liter). The fixative solution was prepared onboard using Milli-Q water (stir for ~1h, let settle overnight, decant) and kept refrigerated until deployment. Falcon tube columns were washed with Milli-Q water (3x) and dried overnight before being filled with fixative solution. The tops of the traps were covered with parafilm to prevent the fixative release during mooring descent (right). The parafilm was secured with rubber bands attached to a magnesium fusible link that dissolves after a few days in seawater. When the link dissolves, a rubber band pulls off the plastic film, opening the trap.



*Larval traps covered with parafilm secured with rubber bands and magnesium links.*

### **PAP3 previous mooring recovery**

On 27/5/2018, LO<sup>3</sup>CA<sup>2</sup>ed sampling devices were recovered from PAP#3 mooring, deployed as station DY077-040 on 20/4/2017 during the 2017 PAP cruise. Once the frames were brought on board, they were immediately taken to the controlled-temperature room set to 4°C. Individual substrate containers were transferred to 5 L plastic buckets and kept refrigerated until the second set of frames was recovered from the mooring line about one hour later. Similarly, the later substrates were put in 5 L buckets in the cold room until further processing (see below). Falcon tube columns containing DMSO-fixed trap samples were removed from the PVC frame. All tube traps were opened and parafilm covers were still attached to both frames, at 2960 and 4730 m. However, one of the four larval tube traps of the deeper frame was lost (broken), and only three samples were recovered from 4730 m depth. Individual DMSO-preserved larval trap samples were transferred to 120 mL labelled sample vials. Because the deeper frames were inverted during the mooring recovery, a smaller volume was retrieved from the deeper traps than the shallower ones although trapped particles were still visible.

Each substrate sample was processed as follows: 1) PVC container was transferred from bucket to clean plastic tray; 2) net basket was removed from the PVC container; 2) line securing the top of the net basket was cut and top net cover was lifted; 3) substrate top view was photographed; 4) subsamples were preserved into different fixatives (below) for future processing in the laboratory. Ethanol-cleaned scissors and forceps were used to cut net lines and transfer substrate samples.





Recovery of the two sets of LO<sup>3</sup>Cated frames, from 2960 m (left) and 4730 m (right) on the PAP#3 mooring.

*Distribution of substrate samples among different fixatives.*

Substrate	-80°C	4% Formalin	95% Ethanol <sup>1</sup>
Wood	2 laths	2 laths	Remaining laths
Bone	2-3 pieces	2 pieces	Remaining pieces
Shells	4 valves	4 valves	Remaining valves

<sup>1</sup>including mesh net

Similar to samples collected one year ago, experimental substrates showed no visible signs of degradation, apart from variable remains of meat and fat still attached to the bones. However, at 4730m bone surfaces were generally cleaner than bones retrieved from 2960 m and revealed small patches of reducing bacterial growth. No macro-organisms were observed on any substrates at both deployment depths. A summary of samples collected is shown in Table 3.

*Summary of samples collected from LO<sup>3</sup>Cated settlement frames after one-year deployment on PAP#3 mooring (DY077-040; 20/4/2017) during JC165. EtOH – Ethanol 95%, bF – Buffered Formalin 4%*

Depth	Settlement frame	Substrate order	Substrate	Preservation
		Top	Shell	EtOH, bF, -80°C
		Middle	Wood	EtOH, bF, -80°C
		Bottom	Bone	EtOH, bF, -80°C
		Top	Wood	EtOH, bF, -80°C
		Middle	Shell	EtOH, bF, -80°C
		Bottom	Bone	EtOH, bF, -80°C
		Top	Bone	EtOH, bF, -80°C
		Middle	Shell	EtOH, bF, -80°C
		Bottom	Wood	EtOH, bF, -80°C
		Top	Shell	EtOH, bF, -80°C
		Middle	Bone	EtOH, bF, -80°C
		Bottom	Wood	EtOH, bF, -80°C

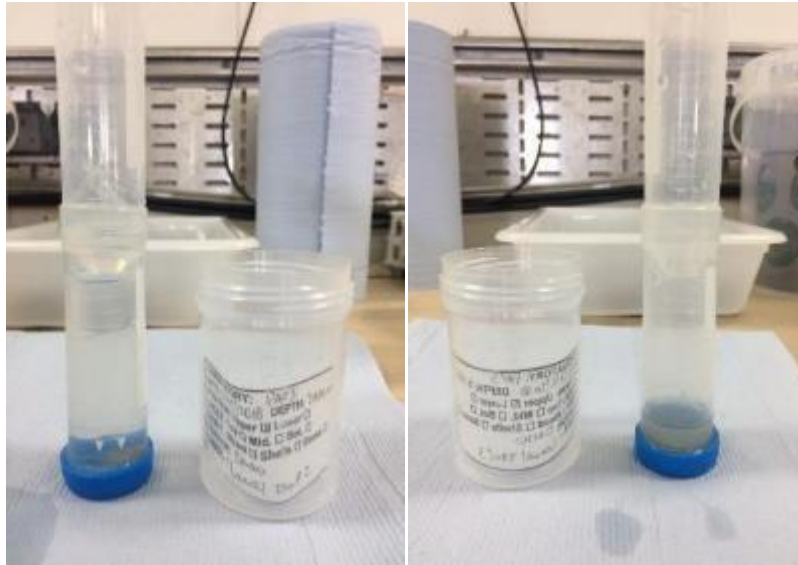

*Representative larval trap samples recovered from 2960m (left) and 4730 m (right) in PAP#3 mooring.*



*Bones samples collected from upper frame at 2960 m (left) and lower frame at 4730 m (right).*

### **Bathysnap**

Two settlement frames were prepared for attachment to Bathysnap frame, deployed as station JC165-68 on 07/06/2018. Wood and shell substrates were previously prepared in the laboratory as described above. Two additional baskets were filled with clinker collected from the trawl sample (OTSB14 station JC165-64, 06/06/2018). Clinker pieces were thoroughly washed with fresh water, boiled for 20 min and air-dried (Fig. 6). Colonization frames were attached upright in both rear sides of the Bathysnap frame. Individual larval tube traps were also prepared as described above (section 1) and attached to the center of the Bathysnap frame. Several attempts to retrieve Bathysnap mooring deployed on 25/04/2017 as station DY077-084 were unsuccessful, therefore substrate and larval trap samples were not recovered.

*Experimental substrates order in each LO<sup>3</sup>CAted settlement frame*

<b>Depth</b>	<b>Frame</b>	<b>Top</b>	<b>Middle</b>	<b>Bottom</b>
	Left (camera)	Shell	Wood	Clinker

	Right (flash)	Wood	Shell	Clinker
--	---------------	------	-------	---------



*Baskets filled with cleaned clinker. One basket was filled with relatively unaltered coal (582 g) with smoother surface, and another was filled with irregular surface mixed burnt coal (623 g).*



*Bathysnap with two LO<sup>3</sup>Cated settlement frames attached upright on the rear sides and four larval traps attached on the top center of the frame around the acoustic release.*

**Future work.** In the laboratory, substrates preserved in ethanol will be screened under a stereomicroscope for meiofauna and macrofauna organisms. Frozen and formalin-fixed substrates will be used for microbial community studies using molecular tools and scanning electron microscopy. Larval trap samples will also be sorted under a stereomicroscope and identified using molecular markers. The results obtained from the PAP Sustained Observatory will be compared with data collected from three other FixO<sup>3</sup> sites (ESTOC, CVOO and PYLOS).

## **16. Acknowledgements**

We thank all the crew of the RRS *James Cook* and the NMF technicians who kept us working to deliver our sometimes rather challenging science programme. This cruise was a contribution to the Climate Linked Atlantic Section Science (CLASS) project supported by the UK Natural Environment Research Council (grant number NE/R015953/1). We would also like to thank the Partnership for Observation of the Global Ocean (POGO) for funding and facilitating the participation of POGO Shipboard Training Fellow Carolina Camargo.

## 17. Station list

The following tabulation provides basic metadata for all operations during RRS *James Cook* cruise 165. *In the case of benthic operations, please refer to the tabulation of benthic station data provided in the body of this cruise report for the full metadata that should be used / reported in any subsequent work (reports / publications).*

**Station number** – formed of deployment cruise and station number; please use as unique identifier.

**Event number** – please use / interpret with great caution, these do not represent unique identifiers and may be employed in an *ad hoc* manner.

**Date** - date on which the deployment was initiated made (note that recovery may be on a later date).

**Latitude / Longitude** – Nominal sample position, please interpret appropriately to the particular instrument operation. All positions are given in degrees and decimal minutes based on the WGS84 datum.

**Sounding** – full depth of the water column (i.e. not necessarily the depth of sample / data collection) provided in uncorrected metres (ucm) based on a uniform assumption of sound velocity as 1500 ms<sup>-1</sup>.

**Time** - time or times given relate to entry into water, first arrival at or near the seafloor, recovery to deck as appropriate to the particular instrument operation. All times given are UTC.

<b>Gear type</b>	<b>Brief description</b>
ATRAP	OBE amphipod trap (modified DEMAR type) mooring
BSNAP	OBE Bathysnap time-lapse camera system mooring
CTD	NMF conductivity temperate and depth instrument, with water bottle rosette
HyBIS	NMF Hydraulic Benthic Instrumented Sampler (camera only mode)
MgCxx+y	Megacorer with xx large units and y small units.
OTSB14a	Semi-balloon otter trawl 14 m head rope (slight rigging variant)
PAP1	MetOffice / NMF ODAS buoy and <i>in situ</i> sensor frame mooring
PAP3	NMF sediment trap string mooring
WP2	OBE UNESCO Working Party 2 plankton ring net (note variant mesh sizes)

Station number	Event No.	Date 2018	Latitude N	Longitude W	Sounding (ucm)	Time in water	Time on bottom	Time on deck	Gear	Comments
DY077-084	1	22.05	49° 00.020	16° 23.670					BSNAP	Lost
JC165-001	2	22.05	49° 00.020	16° 23.670		10:28			CTD	Fuse blown, re-do CTD test CTD 01
JC165-002	3	22.05	49° 00.020	16° 23.676	4810	12:05		12:19	CTD	Test CTD 02
JC165-003	4	22.05	49° 00.197	16° 23.676	4810	14:10		14:49	CTD	Shallow calibration CTD 03
JC165-004	5	22.05	48° 50.067	16° 31.570	4810	20:34			MgC08+2	
JC165-005	6	23.05	48° 50.425	16° 31.192	4870	01:27			MgC08+2	
DY077-019	7	23.05	49° 02.288	16° 19.690	4808			08:51	PAP1	PAP1 recovered buoy and frame
JC165-006	8	23.05	48° 59.280	16° 23.327	4811	12:35		17:21	CTD	CTD 04, deep
JC165-007	9	23.05	48° 50.369	16° 31.265	4809	20:58			MgC08+2	
JC165-008	10	24.05	48° 50.292	16° 31.367	4808	01:51			MgC08+2	
JC165-009	11	24.05	48° 50.490	16° 31.27	4807	08:11	10:20	17:06	HyBIS	
JC165-010	12	24.05	48° 50.458	16° 31.291	4808	21:24			MgC08+2	
JC165-011	13	25.05	48° 50.469	16° 31.412	4080	02:48			MgC08+2	
JC165-012	14	25.05	49° 00.244	16° 29.587	4897	07:28		07:49	CTD	Shallow CTD 05
JC165-013	15	25.05	48° 59.797	16° 29.732	4809	09:12		10:58	PAP3	With colonisation substrates and larval samplers
JC165-014	16	25.05	48° 59.669	16° 24.048	4811	12:05		16:11	CTD	Deep, CTD 06
JC165-015	17	25.05	48° 50.207	16° 31.040	4808	20:31			MgC08+2	
JC165-016	18	26.05	48° 50.183	16° 31.463	4810	01:16			MgC08+2	
JC165-017	19	26.05	48° 50.490	16° 31.123	4808	07:50		18:36	HyBIS	

Station number	Event No.	Date 2018	Latitude N	Longitude W	Sounding (ucm)	Time in water	Time on bottom	Time on deck	Gear	Comments
JC165-018	20	26.05	48° 50.367	16° 31.453	4809	22:12			MgC08+2	
JC165-019	21	27.05	48° 50.227	16° 31.403	4809	02:52			MgC08+2	
DY077-040	22	27.05	48° 59.950	16° 27.620	4809	06:58			PAP3	PAP3 recovery
JC165-020	23	27.05	49° 0.728	16° 28.790	4809	10:56		11:20	WP2	Zooplankton net #1
JC165-021	24	27.05	49° 00.056	16° 28.577	4809	11:21		11:46	WP2	Zooplankton net #2
JC165-022	25	27.05	49° 00.252	16° 28.252	4809	12:55		11:13	ATRAP	Amphipod Trap, deployed 27.05.2018, recovered 29.05.2018
JC165-023	26	27.05	49° 00.383	16° 28.292	4809	14:17			CTD	Shallow CTD 07
JC165-024	27	27.05	49° 00.383	16° 28.291	4809	16:05	17:00	18:52	CTD	Deep, CTD 08
JC165-025	28	27.05	48° 50.317	16° 31.218	4808	22:39			MgC08+2	
JC165-026	29	28.05	48° 50.254	16° 30.883	4810	03:13			MgC08+2	
JC165-027	30	28.05	48° 50.489	16° 31.575	4808	08:15			HyBIS	Tech problem - came up early
JC165-028	31	28.05	48° 50.489	16° 31.574	4806	10:57	13:01	18:39	HyBIS	
JC165-029	32	28.05	48° 50.201	16° 31.266	4809	22:33			MgC10	
JC165-030	33	29.05	48° 00.314	16° 29.813	4809	12:23		12:46	WP2	Zooplankton net #3
JC165-031	34	29.05	48° 00.284	16° 30.032	4808	12:51		13:20	WP2	Zooplankton net #4
JC165-032	35	29.05	48° 00.056	16° 30.196	4809	14:08			CTD	CTD 09, deep
JC165-033	36	29.05	48° 50.355	16° 30.944	4808	22:08			MgC10	
JC165-034	37	30.05	48° 50.313	16° 30.994	4808	04:14			MgC10	
JC165-035	38	30.05	48° 50.490	16° 31.421	4807	10:30	12:23	18:11	HyBIS	

Station number	Event No.	Date 2018	Latitude N	Longitude W	Sounding (ucm)	Time in water	Time on bottom	Time on deck	Gear	Comments
JC165-036	39	30.05	48° 50.168	16° 31.279	4808	19:51			MgC10	ABORTED
JC165-037	40	30.05	48° 50.168	16° 31.278	4808	23:24			MgC10	
JC165-038	41	31.05	48° 59.389	16° 33.170	4773	10:36	12:43	18:10	HyBIS	
JC165-039	42	31.05	48° 58.939	16° 33.026	4738	21:28			MgC08+2	
JC165-040	43	01.06	48° 59.030	16° 33.013	4745	01:47			MgC08+2	
JC165-041	44	01.06	49° 00.247	16° 28.183	4810	07:25			ATRAP	Amphipod Trap, deployed 01.05.2018, recovered
JC165-042	45	01.06	49° 01.770	16° 30.081	4810	10:44		11:05	WP2	Zooplankton net #5
JC165-043	46	01.06	49° 01.675	16° 30.228	4807	11:11		11:31	WP2	Zooplankton net #6
JC165-044	47	01.06	49° 01.595	16° 30.362	4807	11:35		11:52	WP2	Zooplankton net #7
JC165-045	48	01.06	49° 00.142	16° 30.513	4807	13:00		13:45	CTD	CTD shallow, CTD 10
JC165-046	49	01.06	49° 00.141	16° 30.513	4807	15:00		18:27	CTD	CTD deep, CTD 11
JC165-047	50	02.06	48° 58.960	16° 32.852	4731	19:42			MgC	
JC165-048	51	02.06	49° 58.959	16° 32.854	4737	23:31		00:04	WP2	Zooplankton net #8
JC165-049	52	03.06	48° 58.938	16° 33.070	4737	00:21		00:53	WP2	Zooplankton net #9
JC165-050	53	03.06	48° 58.991	16° 33.361	4749	01:02		01:25	WP2	Zooplankton net #10 63 µm
JC165-051	54	03.06	48° 58.922	16° 33.120	4741	03:51			MgC08+2	
JC165-052	55	03.06	48° 59.390	16° 33.021	4772	08:09	10:10	18:15	HyBIS	
JC165-053	56	03.06	48° 58.890	16° 33.297	4766	21:25			MgC08+2	
JC165-054	57	03.06	48° 58.893	16° 33.310	4742	23:36		23:56	WP2	Zooplankton net #11 63µm



Station number	Event No.	Date 2018	Latitude N	Longitude W	Sounding (ucm)	Time in water	Time on bottom	Time on deck	Gear	Comments
JC165-055	58	04.06	48° 58.902	16° 33.458	4751	00:00		00:30	WP2	Zooplankton net #12
JC165-056	59	04.06	48° 58.962	16° 33.766	4767	00:35		01:06	WP2	Zooplankton net #13
JC165-057	60	04.06	48° 58.964	16° 32.866	4743	03:28			MgC08+2	
JC165-058	61	04.06	48° 51.859	16° 25.391	4807	09:07			PAP1	Deployment of PAP1 mooring
JC165-059	62	04.06	48° 58.924	16° 32.902	4738	21:01			MgC06+2	
JC165-060	63	04.06	48° 58.926	16° 32.908	4737	23:00		23:16	WP2	Zooplankton net #14. Quick but all fine.
JC165-061	64	04.06	48° 58.941	16° 32.951	4739	23:23		23:53	WP2	Zooplankton net #15
JC165-062	65	05.06	48° 58.946	16° 33.038	4741	00:03		00:33	WP2	Zooplankton net #16
JC165-063	66	05.06	48° 58.991	16° 33.081	4743	02:41			MgC06+2	
M108-768	67	05.06	49° 01.720	16° 19.910		10:29		13:37	PAP1	
JC165-064	68	05.06	49° 06.914	17° 4.214	4808	20:32		08:41	OTSB14a	
JC165-065	69	06.06	48° 59.399	16° 33.415	4770	10:52	12:38	18:19	HYBIS	
JC165-066	70	06.06	48° 58.971	16° 33.270	4748	23:18			MgC06+2	
JC165-067	71	07.06	48° 58.832	16° 33.191	4737	03:24			MgC06+2	
JC165-068	72	07.06	49° 00.310	16° 27.833		06:30			BSNAP	With colonisation substrates and larval samplers
JC165-069	73	07.06	48° 56.705	16° 25.602	4808	12:21			CTD	CTD 12 500m
JC165-070	74	07.06	48° 56.705	16° 25.602	4750	14:27			CTD	CTD 13 Deep
JC165-071	75	07.06	48° 58.907	16° 33.284	4746	21:51			MgC06+2	
JC165-072	76	08.06	48° 58.874	16° 33.028	4731	02:02			MgC06+2	

Station number	Event No.	Date 2018	Latitude N	Longitude W	Sounding (ucm)	Time in water	Time on bottom	Time on deck	Gear	Comments
JC165-073	77	08.06	48° 59.390	16° 33.395	4805	06:47	08:42	18:22	HyBIS	
JC165-074	78	08.06	48° 50.728	16° 54.518		21:20		08:48	OTSB14a	
JC165-075	79	09.06	49° 07.554	16° 40.081	4202	09:51			HyBIS	Ben Billett seamount