



British Geological Survey

REGIONAL GEOPHYSICS RESEARCH GROUP

Technical Report WK/90/20

Regional Geophysics Series

Two trial scalar audiomagnetotelluric soundings in southern Scotland

D Beamish



This report has been generated from a scanned image of the document with any blank pages removed at the scanning stage.
Please be aware that the pagination and scales of diagrams or maps in the resulting report may not appear as in the original

British Geological Survey
Natural Environment Research Council

Technical Report WK/90/20

Regional Geophysics Series

Two trial scalar audiomagnetotelluric soundings in southern Scotland

D Beamish

Cover illustration

Non-polarising electrode in use. Part of measurement of induced electric field

Subject index

Geophysics, electromagnetic, resistivity, trials

Bibliographic reference

BEAMISH, D. 1990. Two trial scalar audiomagnetotelluric soundings in southern Scotland. *British Geological Survey Technical Report WK/90/20*.

TECHNICAL REPORT WK/90/20

**Two trial scalar audiomagnetotelluric
soundings in southern Scotland**

D Beamish

British Geological Survey
Natural Environment Research Council

TECHNICAL REPORT WK/90/20
Regional Geophysics Series

**Two trial scalar audiomagnetotelluric
soundings in southern Scotland**

D. Beamish

Cover illustration

Non-polarising electrode in use. Part of
measurement of induced electric field.

Subject index

Geophysics; electromagnetic, resistivity,
trials.

Bibliographic reference

BEAMISH, D., 1990. Two trial scalar
audiomagnetotelluric soundings in
southern Scotland. *British Geological
Survey Technical Report WK/90/20.*

CONTENTS

	PAGE
1. INTRODUCTION	1
2. BACKGROUND	1
3. NOTES ON THE SAMTEC1 SYSTEM	2
4. DESCRIPTION OF THE SOUNDINGS	3
5. DESCRIPTIONS OF THE DATA	3
6. ASSESSMENT OF THE SOUNDINGS	4
7. CONCLUSIONS	6
8. REFERENCES	8
FIGURES (14)	
APPENDIX A	
APPENDIX B	

1. INTRODUCTION

This report describes two trial demonstrations of a commercial (BRGM) scalar audiomagnetotelluric (AMT) system in southern Scotland. Scalar AMT measurements are high frequency (e.g. 1 to 10,000 Hz) electromagnetic (EM) soundings of near-surface resistivity structure employing natural source fields. Since the energising source field is effectively at infinity, the depth of penetration of such a system is usually much greater than in the more familiar EM systems necessarily constrained by the separation between a transmitter and receiver.

The demonstrations were arranged to investigate whether such a resistivity sounding system could be of value to the BGS in its current and planned programmes of geophysical work. BGS already has experience with low frequency tensor MT and AMT measurements for regional geophysical investigations (e.g. Beamish 1986). In principle therefore, much processing, modelling and interpretation software already exists, or could be modified, for data acquired by a high frequency scalar AMT system. The principle aim of scalar AMT systems (when compared with broadband tensor MT) is to provide rapid and dense survey information with regard to resistivity structure from the near-surface (tens of metres) to several kilometres depending on the geological environment. A review of the technique together with a number of case histories is given by Strangway (1983). Typical applications of the technique are numerous and include massive sulphide detection, mapping of resistivities in shales, hydrogeological investigations and stratigraphic mapping.

The principal aim of this report is an evaluation of the BRGM scalar AMT system in relation to possible BGS requirements. In order to carry out a complete assessment however, the data obtained at the two locations have been subjected to one-dimensional inversion. The inversion procedures provide resistivity/depth profiles extending in one case to 4 km and in the second case to 2.75 km. Although the models obtained are not well-constrained, some brief comments on the geological interpretation of the resistivity/depth profiles are provided.

2. BACKGROUND

Scalar AMT measurements and interpretations can be considered a derivative of the full tensor MT method. Scalar AMT involves just two channels, one electric (E) and one magnetic (H), measured in orthogonal directions. To obtain some measure of the resistivity anisotropy at a site it is usual to perform two sets of separate measurements e.g. one with the E measurement N-S and one with the E measurement E-W. Such separate measurements do not provide rotational and directional information as is the case with tensor MT.

Scalar AMT is usually restricted to frequency measurements above 1 Hz. This fact, coupled with the fact that only two channels are measured, makes for a simple, portable field system in which a single scalar sounding can be performed in about 20 minutes. A normal dual set of orthogonal measurements at a site could therefore be completed in under one hour. In principle such a system provides a capability for rapid and dense survey measurements. The low frequency limit of about 1 Hz usually means that the maximum depth of investigation is limited to depths of order 1 to 4 km depending on the geological environment.

At least two commercial SAMT systems, with similar characteristics, are marketed. The French BRGM SAMTEC1 system costs about 23,000 pounds and the current rental is about 1,400 pounds per week. The Canadian SAGAX system costs about 22,000 pounds. A technical description of the SAMTEC1 system tested here is given in the Appendix A.

3. NOTES ON THE SAMTEC1 SYSTEM

The system is dry-cell battery-powered and weighs only 7 kg (22 lbs). It was, in fact, transported as hand-luggage on the flight from Paris to Edinburgh. The 'control' unit (with liquid crystal display) is very easy to use with default automatic mode control of measurements and provides simple 'over-ride' setups for tests and more specific control of measurement quality. At each frequency (F) the system provides four measurements at F, 1.5F, 2F and 3F. Thus the automatic (default) mode frequencies that constitute a measurement cycle are

F	F1.5	F2	F3 (Hz)
2	3	4	6
5	7.5	10	15
10	15	20	30
40	60	80	120
110	165	220	330
180	270	360	540
610	915	1220	1830
1100	1650	2200	3300
2500	3750	5000	7500

Apparent resistivity and phase at these frequencies are stored internally and the 9 measurements (at 34 + 2 repeated frequencies) constitute a measurement cycle. It should be noted that a measurement cycle is only completed when setup parameters which determine how many times the measurement at each frequency is repeated (e.g. from a minimum of say 20 to a maximum of 99, at night) or whether a satisfactory 'quality' or signal/noise criterion has been achieved (prior to the maximum). These parameters determine the time a sounding takes for a particular signal/noise environment. The user also chooses how many measurement cycles to acquire (e.g 1

for a 20 minute sounding, 10 for overnight). Setup parameters also provide control of the way in which the measurement cycles are stacked and a final sounding curve is determined. Electric/magnetic field ratios are averaged through a weighting procedure which depends on either the coherency between the field components or on the standard deviation of the apparent resistivity. Individual measurements and the final sounding curve are stored internally. The unit can store of order 10 sets of soundings which can be routinely downloaded to a variety of field computers (e.g. PC laptop). Other details of the system can be found in Appendix A.

4. DESCRIPTION OF THE SOUNDINGS

Field demonstrations and soundings were performed on November 6 and 7 1989 by M. Flohr and P. Valla of BRGM at Eskdalemuir Observatory (November 6) and at the Earlyburn test site (November 7) to the south of Edinburgh. Each sounding is given an identification number and six 'soundings' were acquired. The first 4 soundings were undertaken at Eskdalemuir and the final 2 soundings (5 and 6) were measurements made at Earlyburn. A map showing the sounding locations in relation to the lithostratigraphic divisions across the Southern Uplands is provided in Figure 1.

Sounding 1 was undertaken on the hillside several hundred metres behind the observatory enclosure wall. The fields obtained at this location proved to be saturated with noise (e.g. 50 Hz and other), producing overloads on the analogue monitoring unit and inconsistent measurements. Sounding 1 was abandoned and the system was transferred to a location (grid reference NY 227 038) away from the immediate vicinity of the Observatory. Sounding 2 was a N-S (telluric) measurement (one complete automatic cycle) and sounding 3 was an E-W (telluric measurement) using 3 complete cycles. To demonstrate the use of a larger number of cycles, sounding 4 was an overnight repeat of sounding 3 (i.e. an E-W telluric measurement) with 10 automatic cycles.

On November 7 the system was transferred to Earlyburn and because of time restrictions only 2 soundings were acquired. Sounding 5 provided 2 automatic cycles of N-S (telluric) data and sounding 6 provided 1 automatic cycle of E-W data.

5. DESCRIPTIONS OF THE DATA

The data stored in the SAMTEC1 unit were transferred to an IBM PC in Murchison House. A typical listing of the sounding data (in terms of successive measurement cycles) is supplied in Appendix B. All data stored in the SAMTEC1 unit are shown including initial manual tests to check performance. The field tests have been described by BRGM (Valla 1990) and two of the final sounding curves plotted by BRGM are shown in Figure 2. The method of display uses the square-root of frequency. E-W

soundings at Eskdalemuir using 3 cycles (sounding 3 during the day) and 10 cycles (sounding 4 at night) are compared in Figure 2. According to BRGM (Valla 1990), the comparison of Figure 2 indicates that the high frequency 'scatter' is greatly reduced by the 10 cycles of measurement. While this may be true, it is very clear that the levels of accuracy achieved in SAMT are very much less than those of MT where we would hope to work to better than 5% in both apparent resistivity and phase. In strict terms a comparison of accuracies in SAMT and MT is unfair because of the difference in bandwidth. The higher frequencies involved in SAMT means that the measurements will encounter many more anthropogenic (e.g. power-distribution) noise fields together with more limited and variable signal strengths. According to conversations with BRGM estimation at the higher frequencies is a common problem and may be related to the source field minimum at several kilohertz.

The final 4 scalar soundings (N-S and E-W at Eskdalemuir and Earlyburn) can be considered representative of the data that might be acquired using the SAMTEC1 system. It should be noted that the sounding at Earlyburn was obtained on a time-scale of 1 hour. The final 4 data sets are plotted in BGS format in Figures 3 and 4. It can be noted that the error estimates of individual points are not always consistent with a 'physical' response which should be a smooth function of frequency.

6. ASSESSMENT OF THE SOUNDINGS

The soundings obtained with the SAMTEC1 system are clearly subject to scatter which is not 'accommodated' by error estimation. Data of this type must be treated with some degree of caution when making assessments of 'true' or 'implied' resistivity structure. The Bostick 'approximate' inverse of the data (Bostick 1977) demonstrates the difficulties. The direct Bostick transforms of the scattered data are shown in Figures 5 and 6 with error estimates in resistivity and depth obtained from the data errors. The approximate resistivity/depth profiles are shown in both logarithmic and linear depth scales. The results shown in Figures 5 and 6 clearly 'reflect' the scatter in the original data. While it seems evident that an increasing resistivity with depth is 'implied' at Eskdalemuir (Figure 5), the resistivity structure at Earlyburn (Figure 6) is much more doubtful.

Information on the penetration depths of the frequency range supplied by the SAMTEC1 system is also available in Figures 5 and 6. The 'minimum' depths in both cases are of order 100m and maximum depths are in the interval 3 to 4 km (Eskdalemuir) and 2.25 to 2.75 km (Earlyburn).

In order to provide more 'constrained' information some form of 'processing' (e.g. smoothing) of the raw sounding information might be considered. The problem with this approach is that it will impose a structure on the data that may be inappropriate

(Tzanis and Beamish 1989). In simple terms the fitting of some 'smoothing' functional form to the data is equivalent to fitting a structural 'model' to the data. A more sensible approach with this type of data may be to perform 1-D inverse procedures on the data which necessarily provide a 'smooth fit' to scattered observations. The difficulties with this approach are that the changes in *gradient* of the sounding data are key elements in the construction of inverse models. Heavily scattered observations (such as the present data) may generate false structural elements to the resistivity profile. In addition the normal 'descent' (to a minimum-norm solution) within an inverse algorithm may well be hampered by both the data scatter and by the resulting inconsistencies in the amplitude and phase components. The situation has been examined by performing two types of data inversion on the data sets as described below.

A layered inversion scheme due to Fischer and Le Quang (1981) has been applied to the four soundings. Figures 7 and 8 show the results for the Eskdalemuir data. Figure 7 shows the minimum-norm solutions for initial models of 5 layers (4 layers plus half-space). Figure 8 shows the fit of the solution models to the data in the N-S (X) and E-W (Y) components. Thin 'oscillatory' layers are observed in the first kilometer (Figure 7) and are probably due to the high-frequency scatter in the data (Figure 8) rather than being genuine. The inverse algorithm finds it very difficult to cope with the scatter in the data and cannot really find a solution satisfying both amplitude and phase information (Figure 8).

Figures 9 and 10 show the equivalent results for the data obtained at Earlyburn. Here similar comments to those above apply but both solution models (Figure 9) provide a 'better' fit to the observations (Figure 10). When allowance is made for the data errors and scatter (Figure 10), the data and the model results suggest that the near-surface (down to say 3 km) resistivity profile at Earlyburn is reasonably one-dimensional and a resistive layer (of order 10,000 ohm.m) occurs in the first 500 m of the model profile (Figure 9).

A smooth inversion scheme due to Constable *et al.* (1987) was next applied to the four soundings. Figures 11 and 12 show the results for the Eskdalemuir data. Figure 11 shows the smooth model solutions together with the root-mean-square (rms) fit to the data, while the fit of the solution to the data is shown graphically in Figure 12. The fit of the smooth solution in the N-S (X) component (Figure 12) together with the fit of the equivalent layered solution (Figure 8) suggests that a 1-D profile cannot be obtained. The solutions for the Y-data at Eskdalemuir a more-or-less constant resistivity (of order 750 ohm.m) profile down to about 5 km.

Figures 13 and 14 show the equivalent results obtained at Earlyburn. A comparison of the layered (Figure 9) and smooth models (Figure 13) obtained at Earlyburn serves to demonstrate the 'lack of constraints' (non-uniqueness) supplied by data with large errors. The point here is that a variety of models could be constructed which all satisfy

the data to a greater or lesser extent. The phase information is particularly 'uninformative' with regard to the choice of a particular model profile. Very little 'true' structure is 'automatically' resolved by such data and 'value judgements' would be required for sensible interpretation.

7. CONCLUSIONS

The SAMTEC1 unit demonstrated and described here clearly provides a lightweight, simple to operate resistivity sounding system with the potential for deep (1 to 4 km) penetration. Rapid and dense (e.g. 100 metres separation) survey measurements would therefore be possible with such a system. The two 'spot' soundings are not exhaustive as to the possibilities of such a system in that profile measurements would normally be obtained. Such measurements would be more informative as to data continuity, repeatability and therefore quality.

The data quality obtained from the test soundings is very poor in relation to more normal tensor measurements. Data of such poor quality may raise more questions than they solve. The assessment of the data in terms of model reconstruction has demonstrated some of the difficulties that might be encountered. If such data were to be routinely acquired the interpretation would be qualitative rather than quantitative and it would involve far more value judgements than is normal. While such a practice might be worthwhile in 'primary' detection of large resistivity contrasts (e.g. faults), it cannot be considered 'useful' in the more quantitative assessments required by applications such as stratigraphic mapping, and hydrogeological and geothermal investigations. Unless accuracies of better than 10% can be demonstrated for a scalar system, it is likely that the general purpose requirements of BGS can only be supplied by more accurate (1 to 5 %) commercial tensor MT systems.

The one-dimensional inverse solutions and misfits at Eskdalemuir (Figures 7,8 and 11,12) indicate that the X-component solutions are of very poor quality and therefore the 'best' representation of the resistivity/depth profile at this site is that obtained using the Y-data. An assessment of the Y-data results in Figures 7 and 11 indicates that resistivity values of between 700 and 2000 ohm.m are found at depths in excess of 1 km. Acceptable (in terms of misfit) inverse solutions have been obtained in both the X and Y component data at Earlyburn (Figures 9,10 and 13,14). If we ignore the 'unresolved' deep resistivity structure below 3 km then the solutions suggest a resistive 'layer' (resistivity of order 10,000 ohm.m) in the upper kilometre. Deeper values lie in the range 700 to 3000 ohm.m and are very similar to the values found at Eskdalemuir.

A broad description of the Southern Uplands as an accretionary prism associated with lower Paleozoic subduction has been given by Legget et al. (1983). Details of the fault-bounded tracts of greywackes that can be mapped as lithostratigraphic formations

are shown in Figure 1, after Stone et al. (1987). Earlyburn, located immediately to the south of the Southern Upland Fault, lies within the Marchburn Formation. The principal lithostratigraphic zoning within the upper few kilometres should be near vertical at this location. It is therefore difficult to envisage an obvious 'candidate' for the 'horizontal' resistive layer indicated in the upper kilometre. An isolated 'spot' sounding is obviously very limited with regard to interpretation possibilities.

Eskdalemuir is located within the Hawick Formation of the Central Group (Figure 1). Here again, the principal near-surface zoning of the greywacke sequence should be near vertical and so 'uniform' near surface resistivities would be anticipated. The resistivity/depth profiles at Eskdalemuir appear to be consistent with such a model and suggest, along with the results obtained at Earlyburn, that resistivity values of between 700 and 3000 ohm.m are associated with the greywacke formations in both the Northern and Central belts of the Southern Uplands.

8. REFERENCES

- BEAMISH D. 1986. Deep crustal geoelectric structure beneath the Northumberland Basin, *Geophys. J. R. astr. Soc.*, **84**, 619-640.
- BOSTICK, F.X. 1977. A simple, almost exact method of magnetotelluric analysis, *Workshop on EM Methods*, University of Utah.
- CONSTABLE, S.C., PARKER, R.L. and CONSTABLE, C.G., 1987. Occam's inversion : A practical algorithm for generating smooth models for electromagnetic sounding data, *Geophysics*, **52**, 289-300.
- FISCHER, G. and LE QUANG, B.V., 1981. Topography and minimisation of the standard deviation in one-dimensional magnetotelluric modelling, *Geophys. J. R. astr. Soc.*, **67**, 257-278.
- LEGGETT, J.K., MCKERROW, W.S. and SOPER, N.J., 1983. A model for the crustal evolution of southern Scotland, *Tectonics*, **2**, 187-210.
- STRANGWAY, D.W., 1983. Audiofrequency magnetotelluric (AMT) sounding, In *Developments in Geophysical Exploration Methods 5*, (Ed. FITCH, A.A.), Applied Science Publishers Ltd.
- STONE, P., FLOYD, J.D., BARNES, R.P. and LINTERN, B.C., A sequential back-arc and foreland basin thrust duplex model for the Southern Uplands of Scotland, *J. Geol. Soc. Lond.*, **144**, 753-764.
- TZANIS, A. and BEAMISH, D., 1989. A high-resolution spectral study of audiomagnetotelluric data and noise interactions, *Geophys. J. Int.*, **97**, 557-572.
- VALLA, P., 1990. Field test of the SAMTEC1 AMT system in Scotland (November 1989), *Note technique BRGM*, 90 GPH 032.

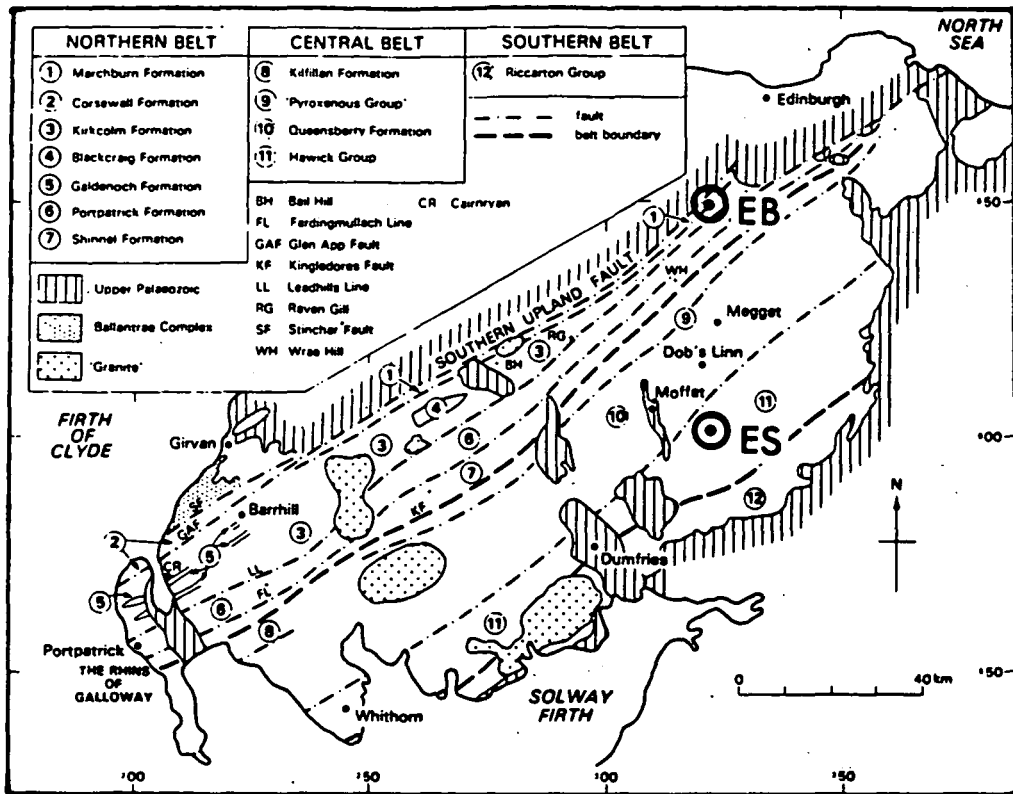

FIGURE 1. Trial sounding locations in relation to the lithostratigraphic divisions within the Southern Uplands, compiled by BGS, after Stone et al. (1987). Earlyburn (EB) and Eskdalemuir (ES) are shown by the heavy circled dots.

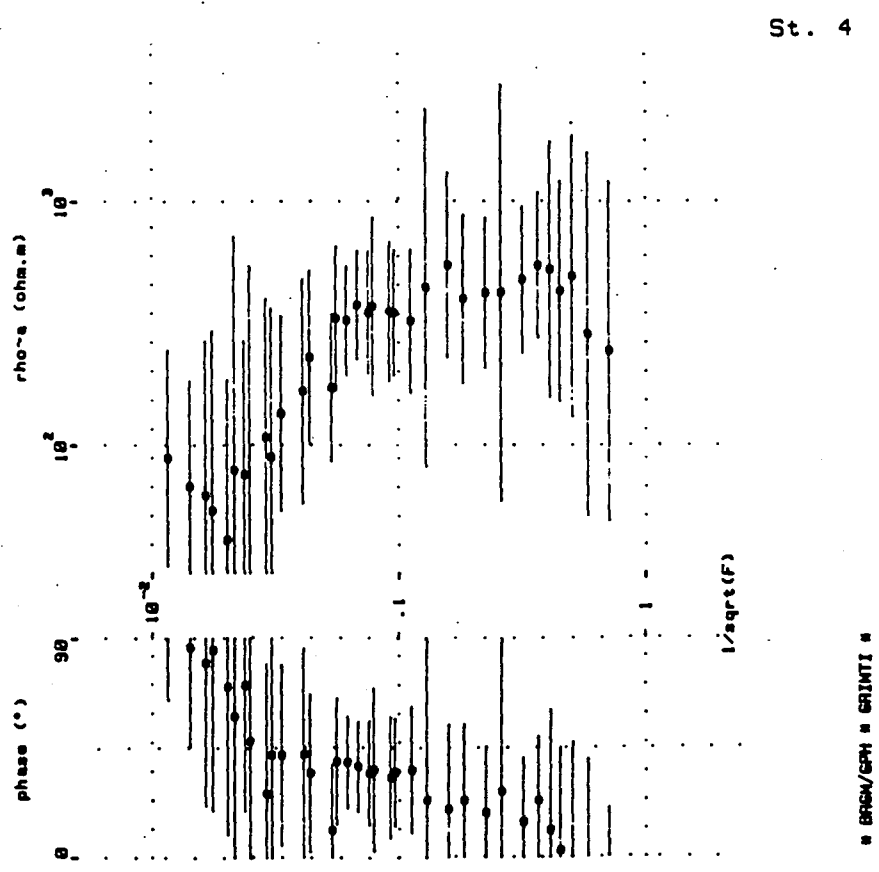
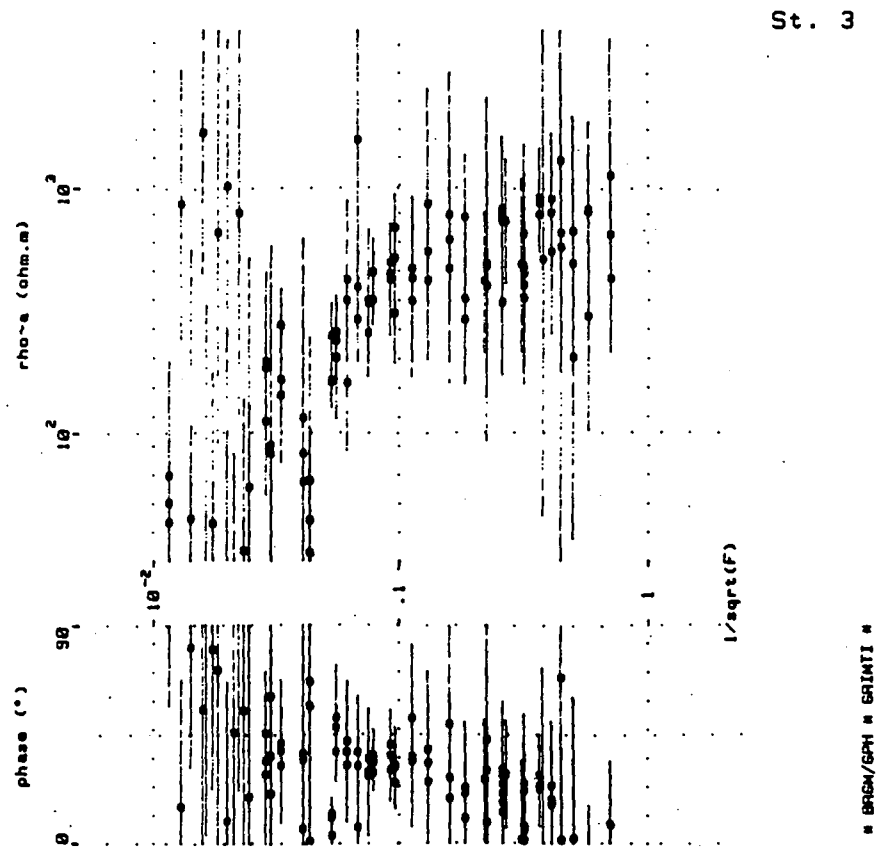

FIGURE 2. Example of final sounding data plotted by BRGM (Valla 1990). Frequency axis is square-root frequency. (a) Sounding 3, E-W component Eskdalemuir, day. 3 measurement cycles. (b) Sounding 4, E-W component Eskdalemuir, night. 10 measurement cycles.

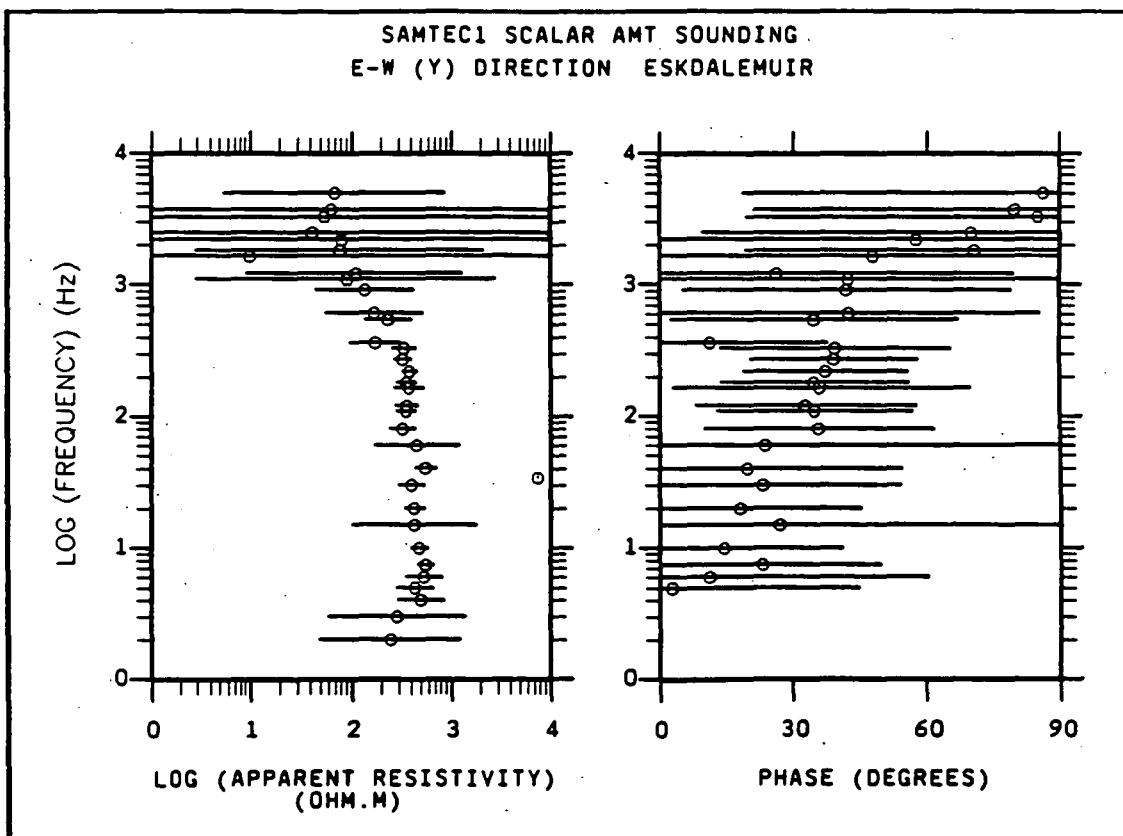
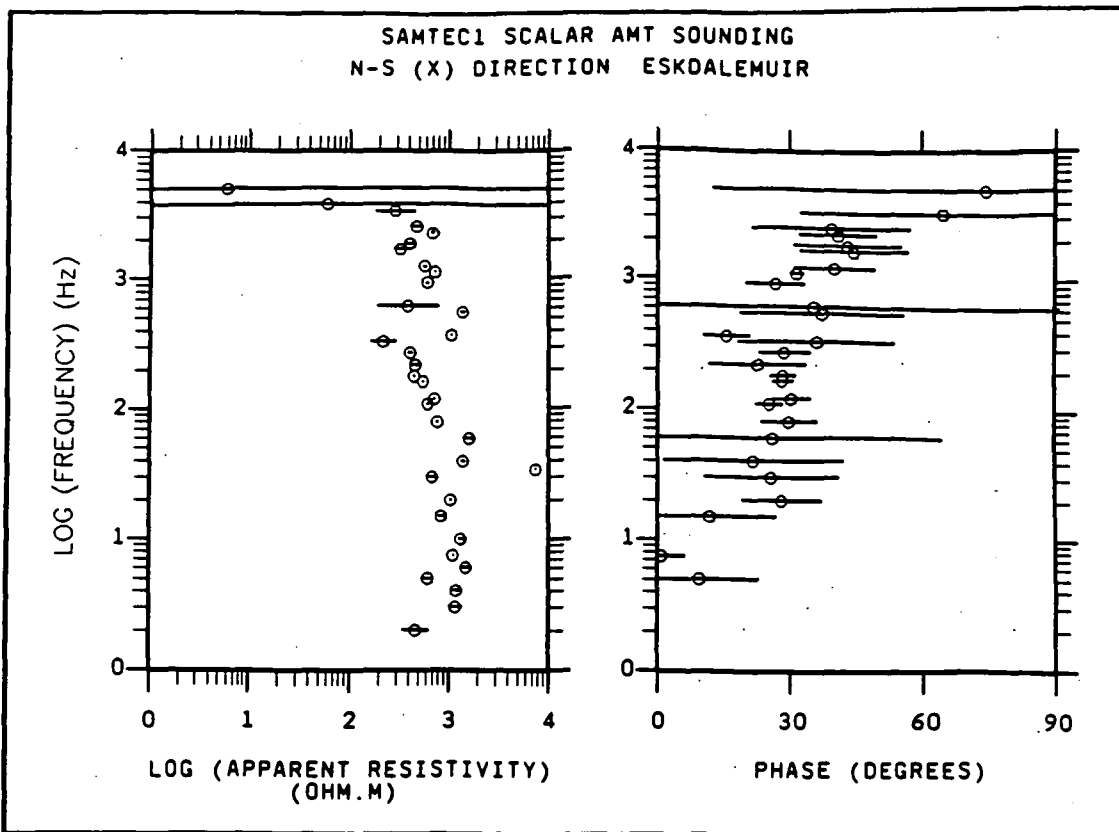

FIGURE 3. Final sounding curves at Eskdalemuir. Data errors are +/- 1 standard deviation.

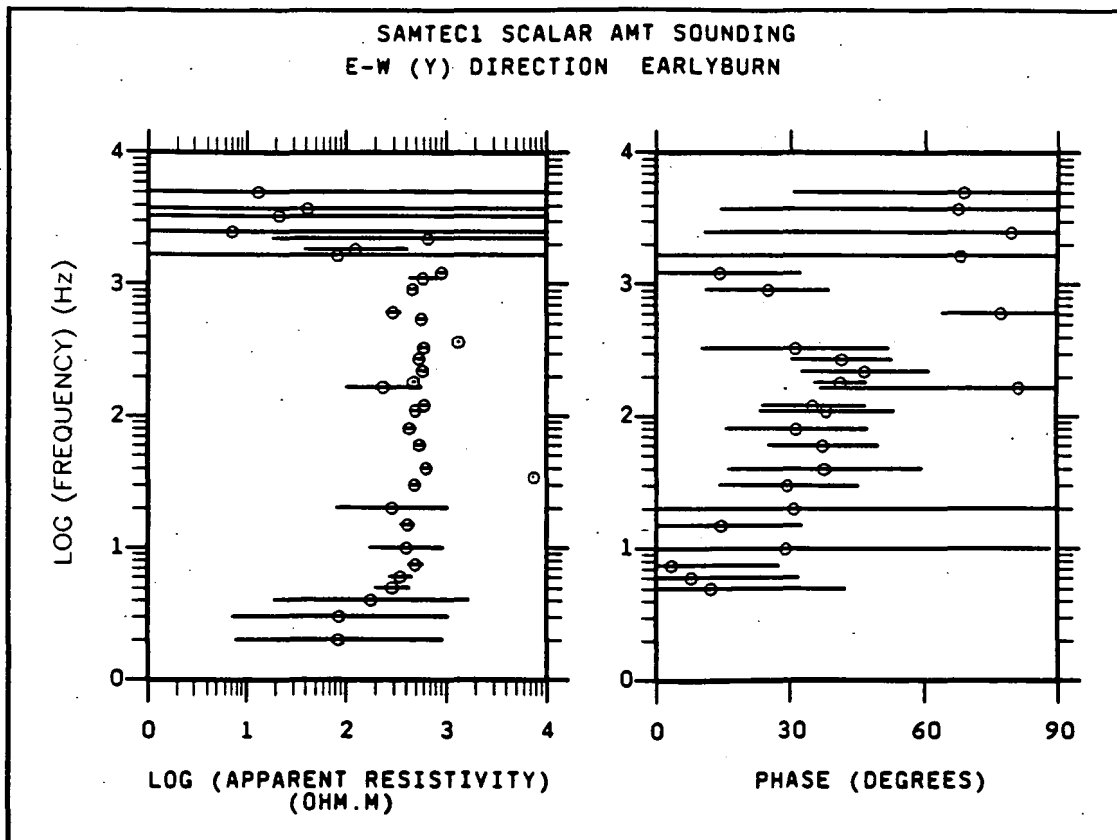
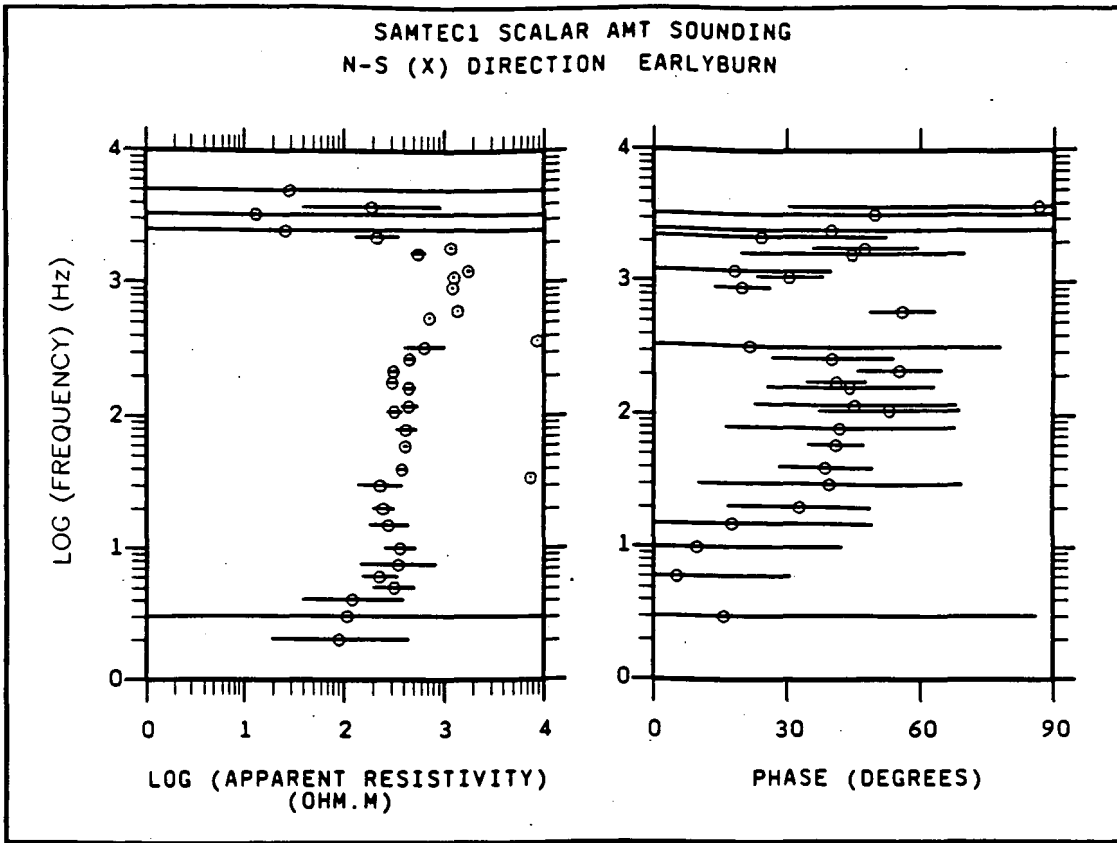

FIGURE 4. Final sounding curves at Earlyburn. Data errors are +/- 1 standard deviation.

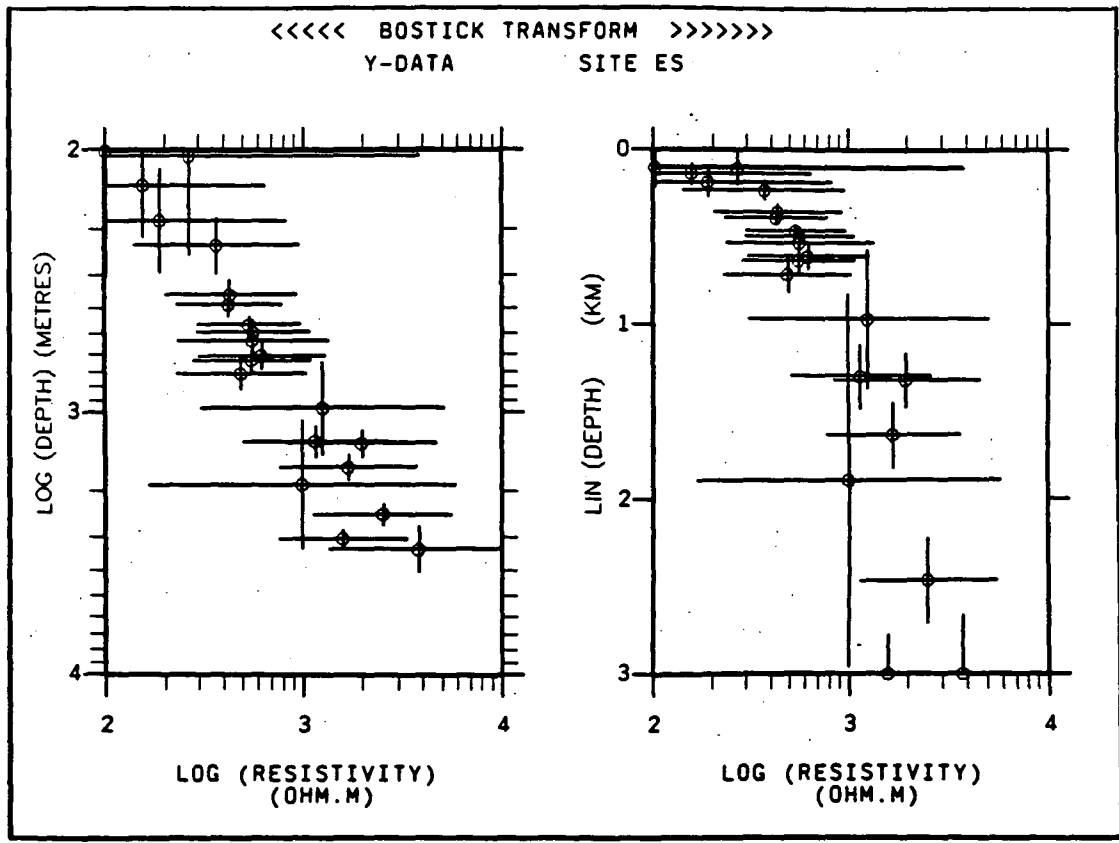
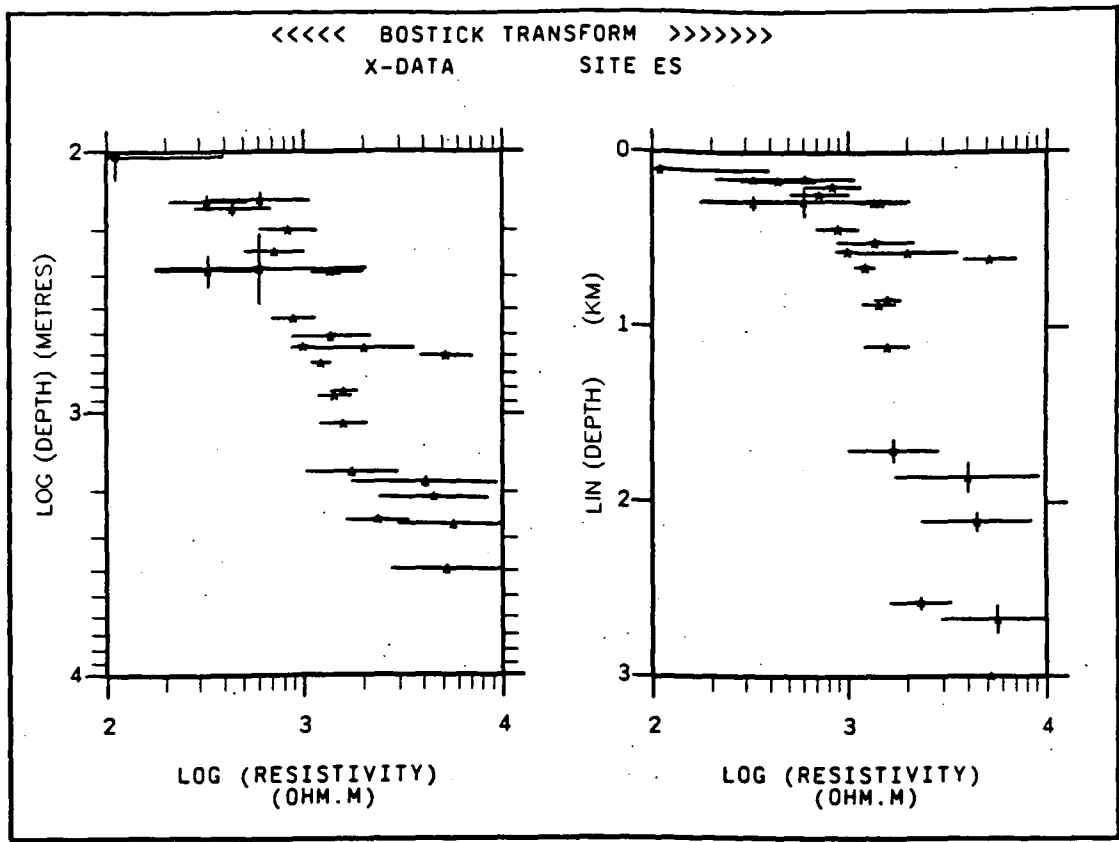

FIGURE 5. Bostick transform of the Eskdalemuir data. Logarithmic (left) and linear (right) depth scales as a function of resistivity (logarithmic scale).

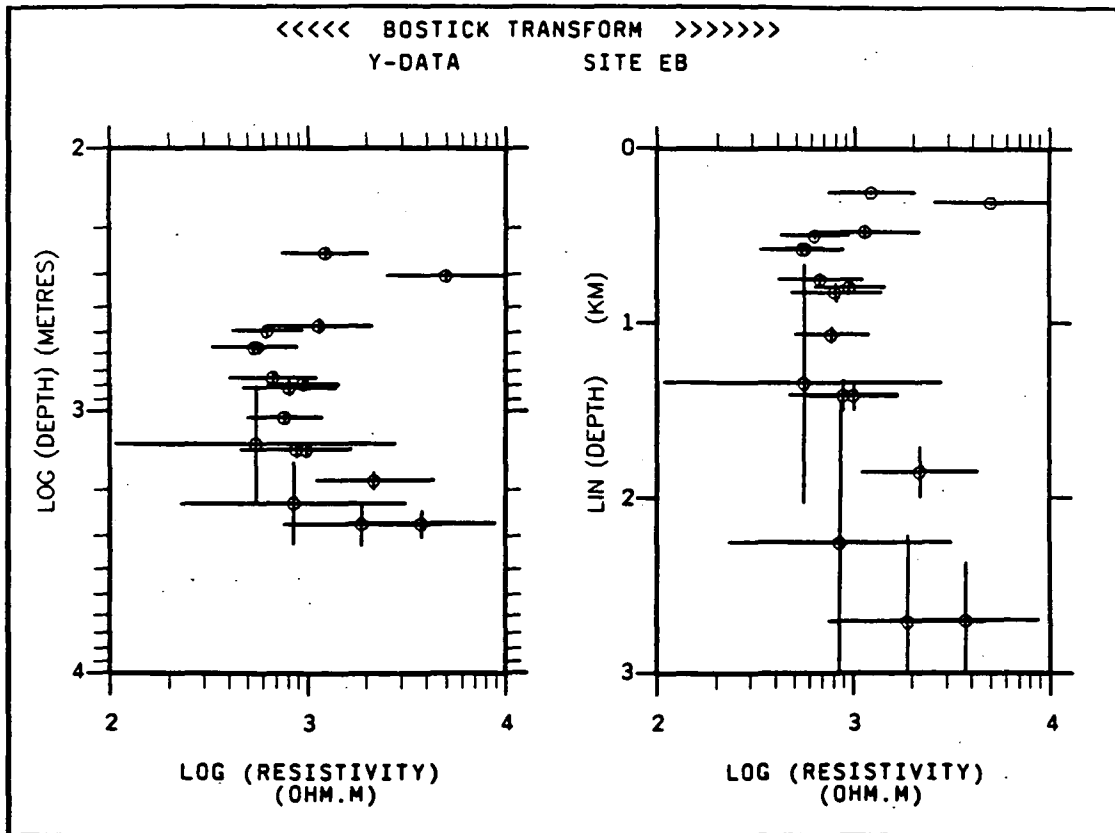
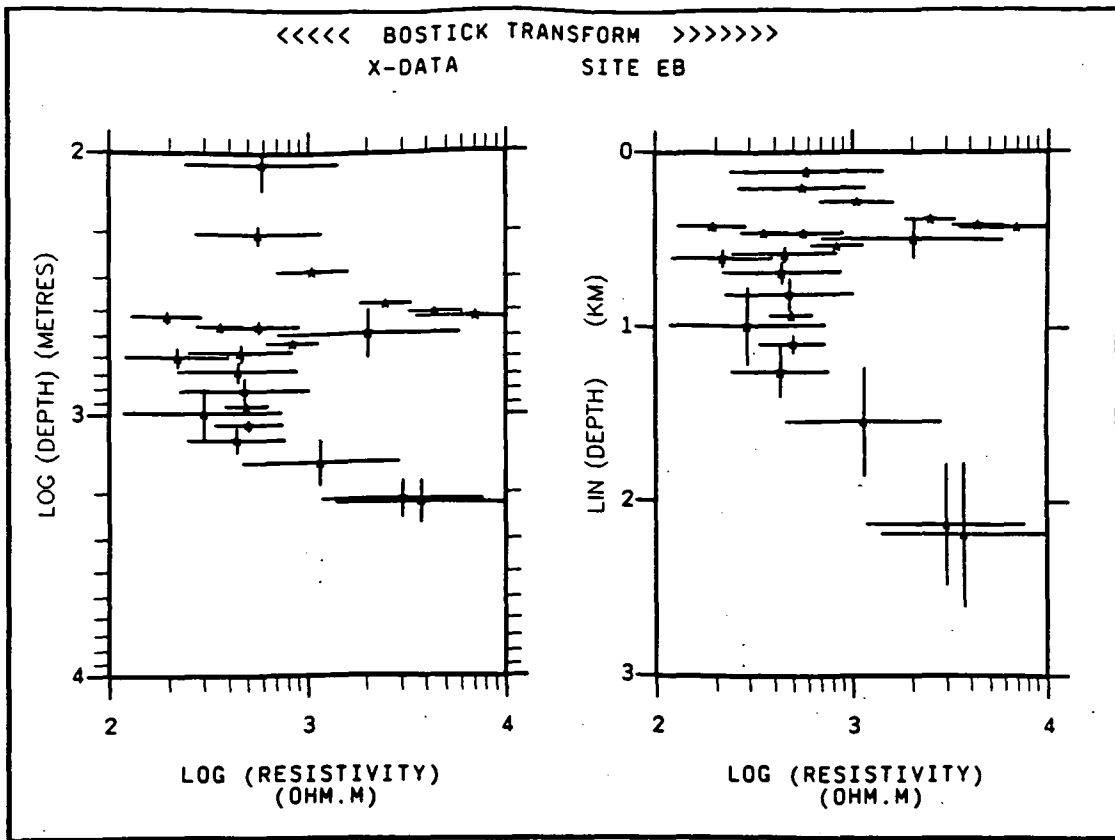

FIGURE 6. Bostick transform of the Earlyburn data. Logarithmic (left) and linear (right) depth scales as a function of resistivity (logarithmic scale).

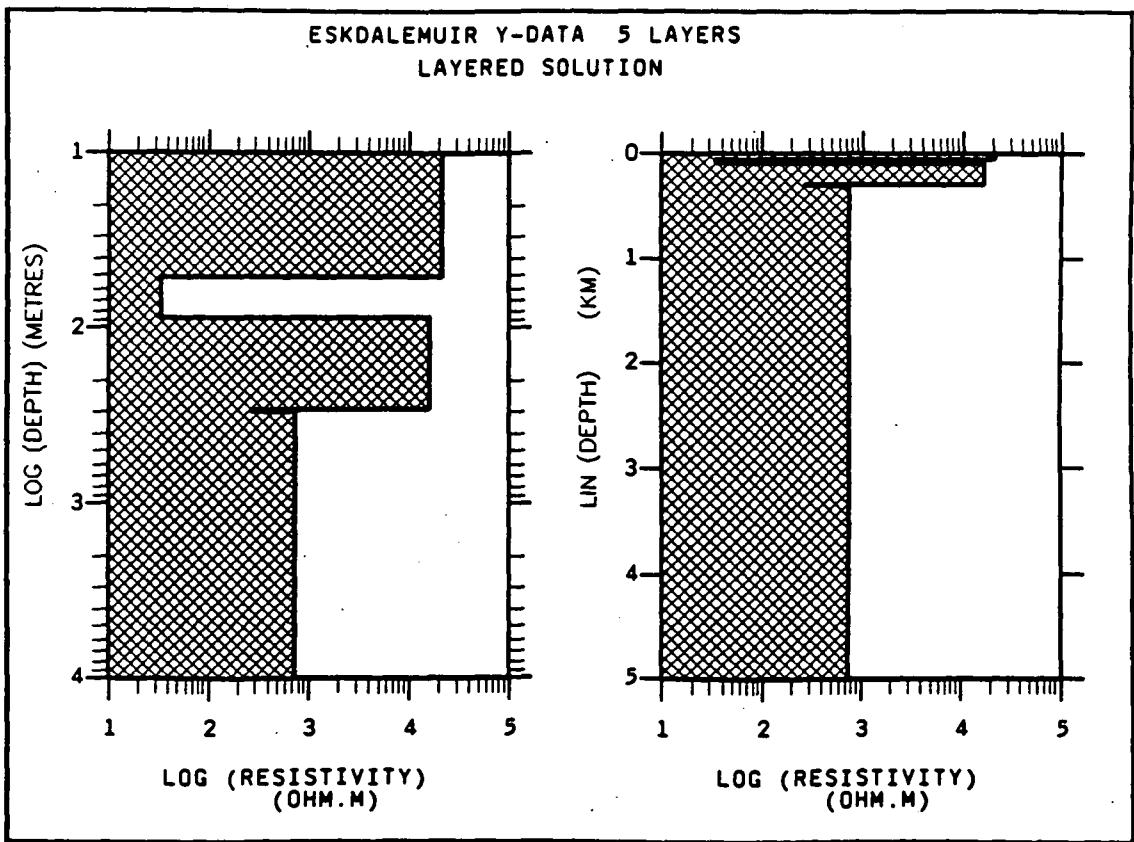
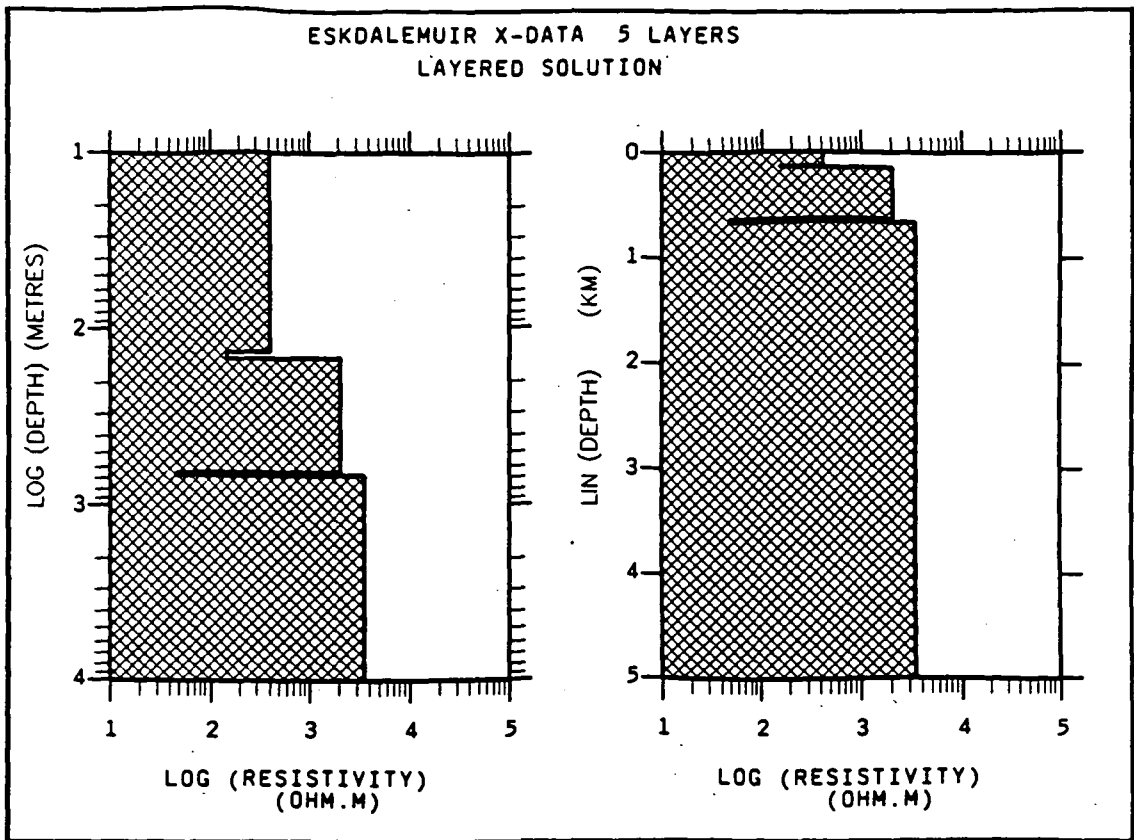

FIGURE 7. Layered inverse solutions to the data at Eskdalemuir. Logarithmic (left) and linear (right) depth scales.

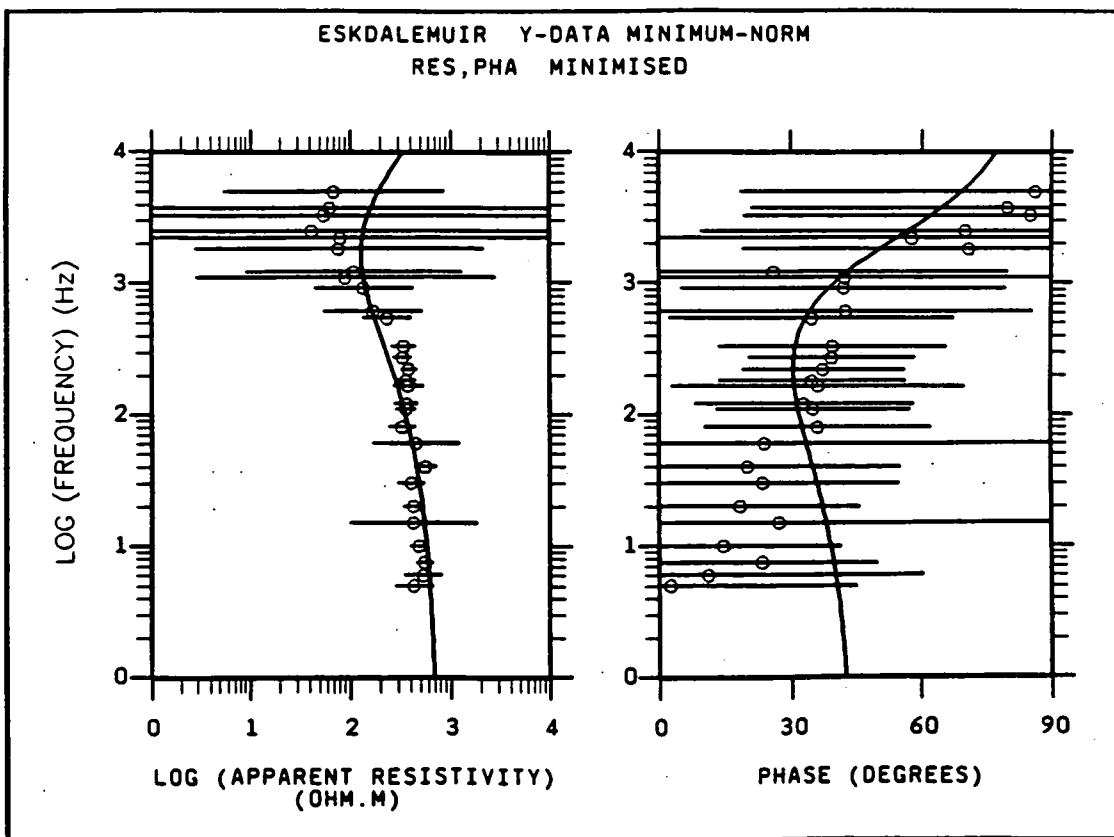
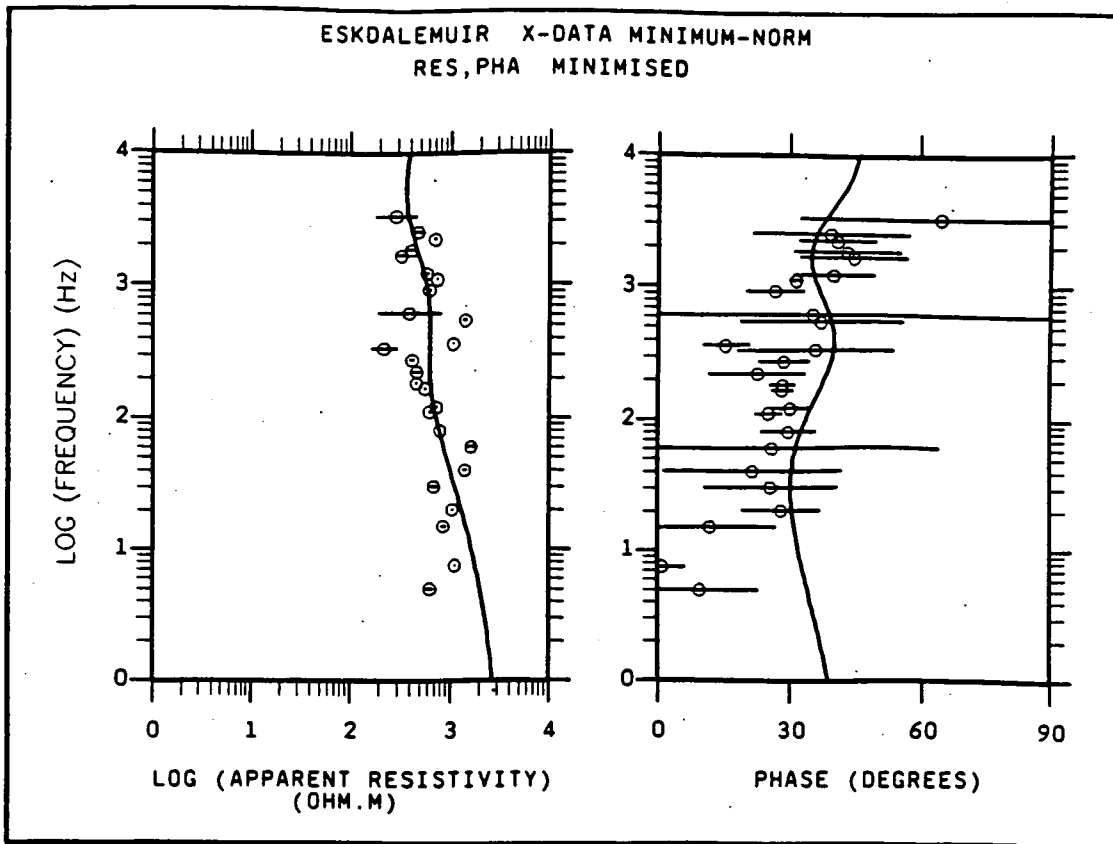

FIGURE 8. Fit of the inverse solutions of Fig. 7 to the data at Eskdalemuir.

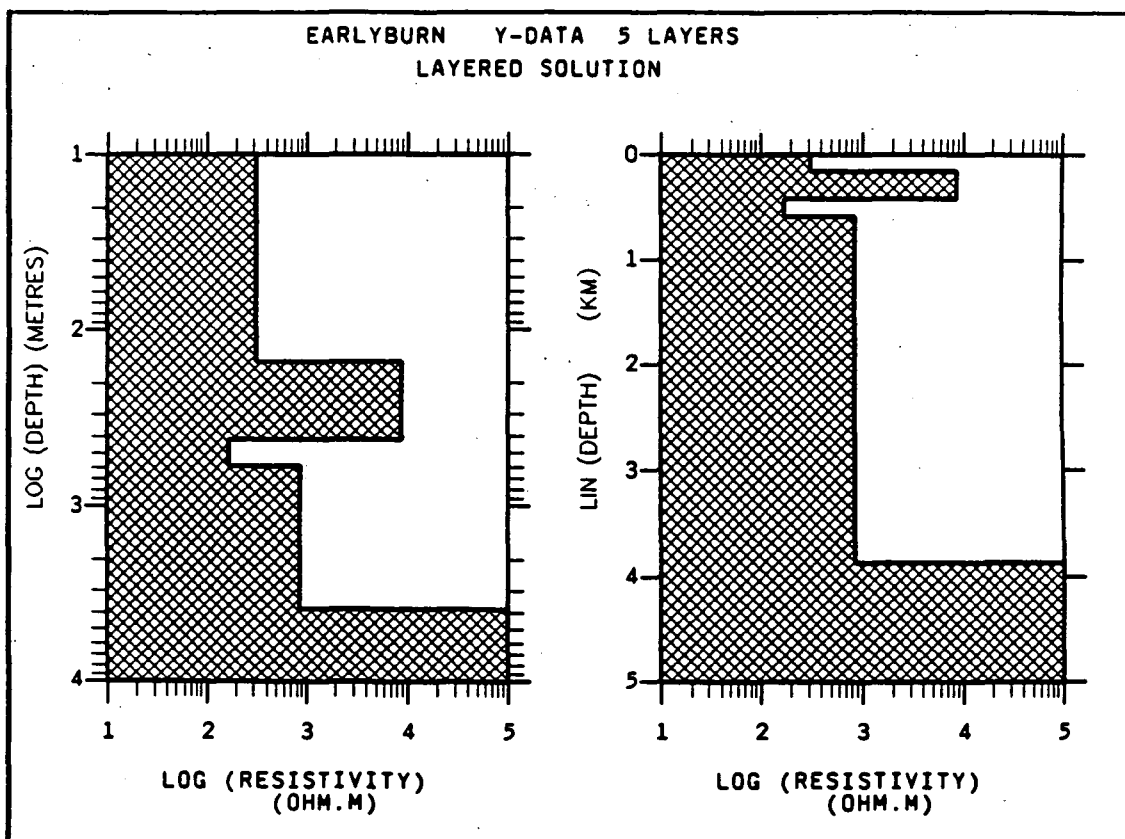
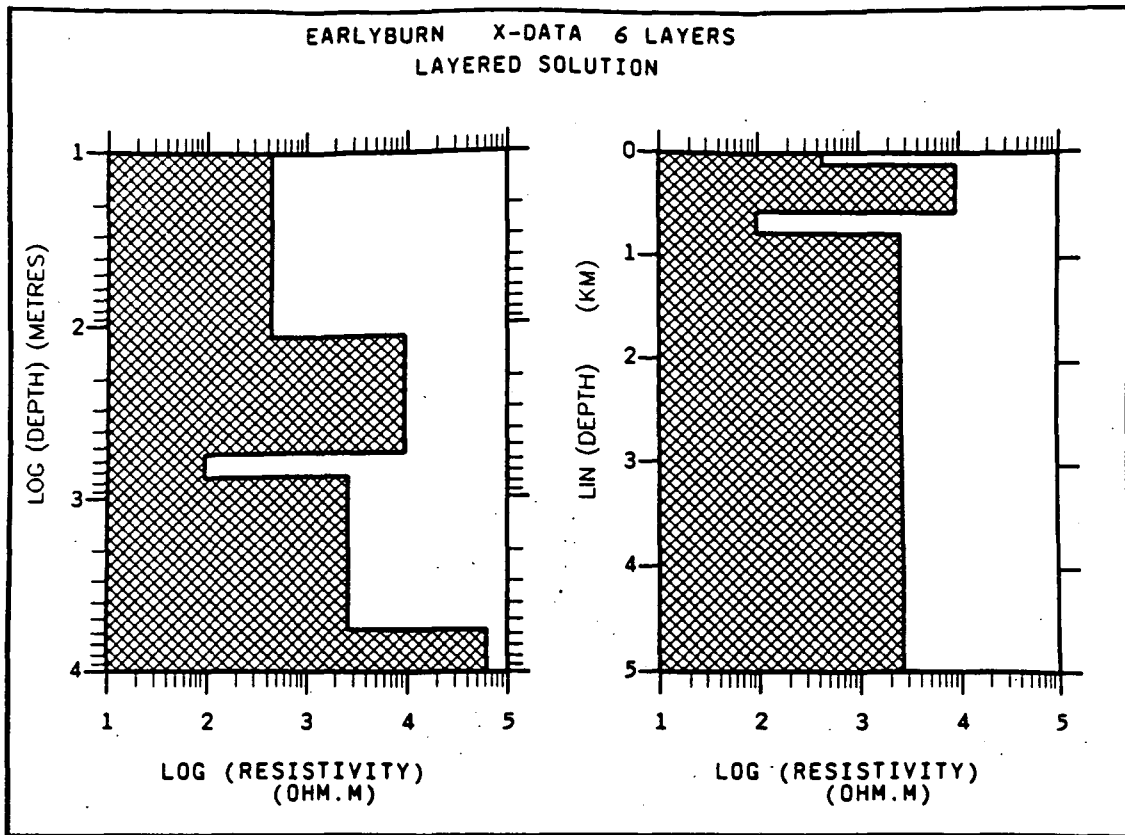

FIGURE 9. Layered inverse solutions to the data at Earlyburn. Logarithmic (left) and linear (right) depth scales.

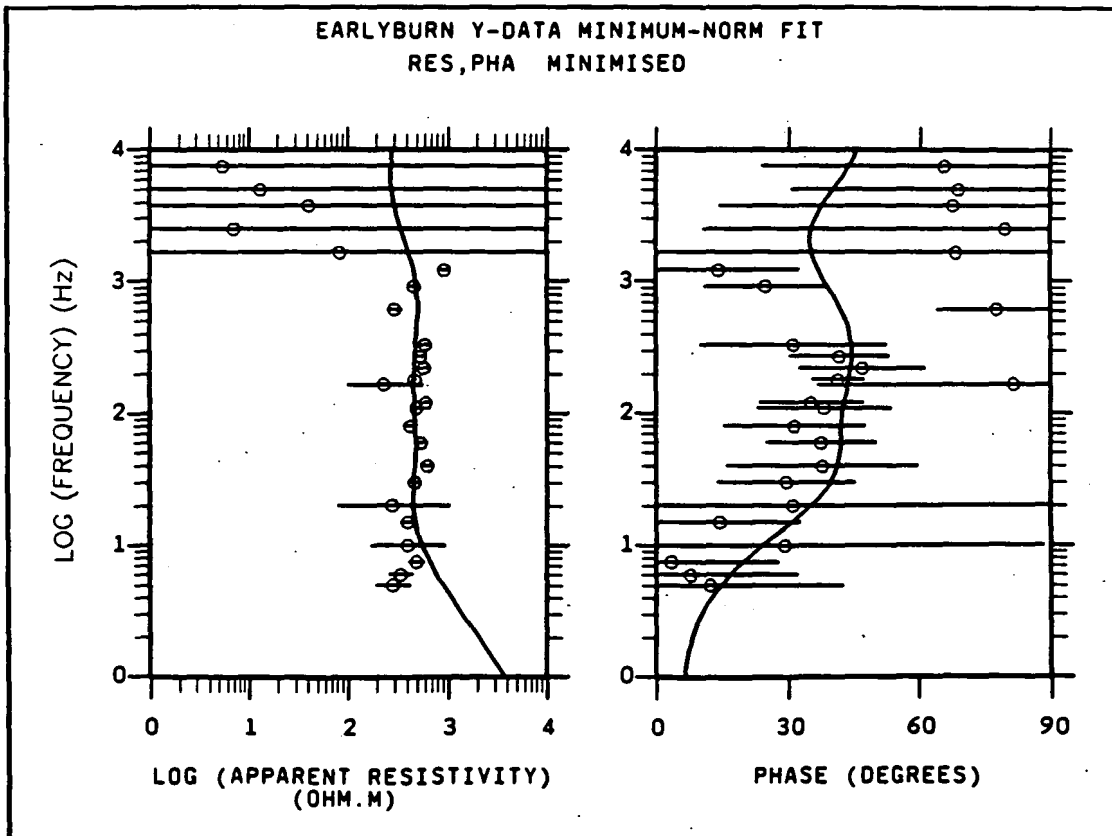
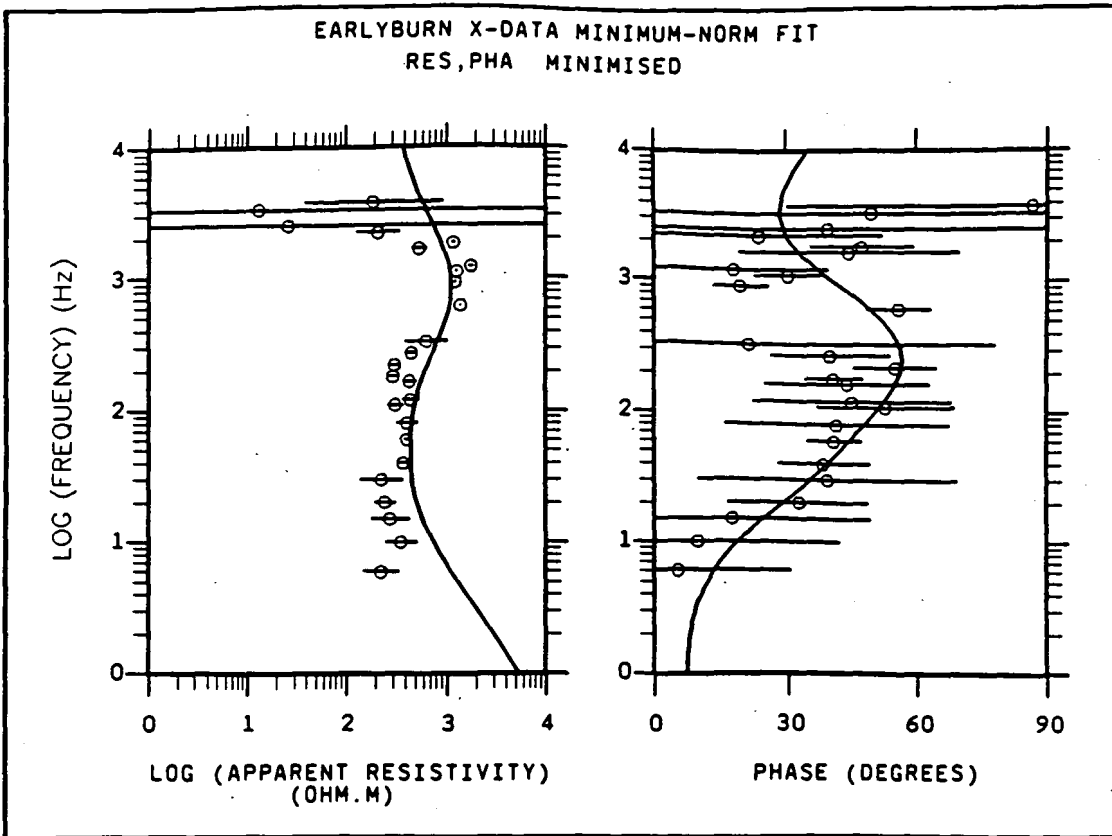

FIGURE 10. Fit of the inverse solutions of Figure 9 to the data at Earlyburn.

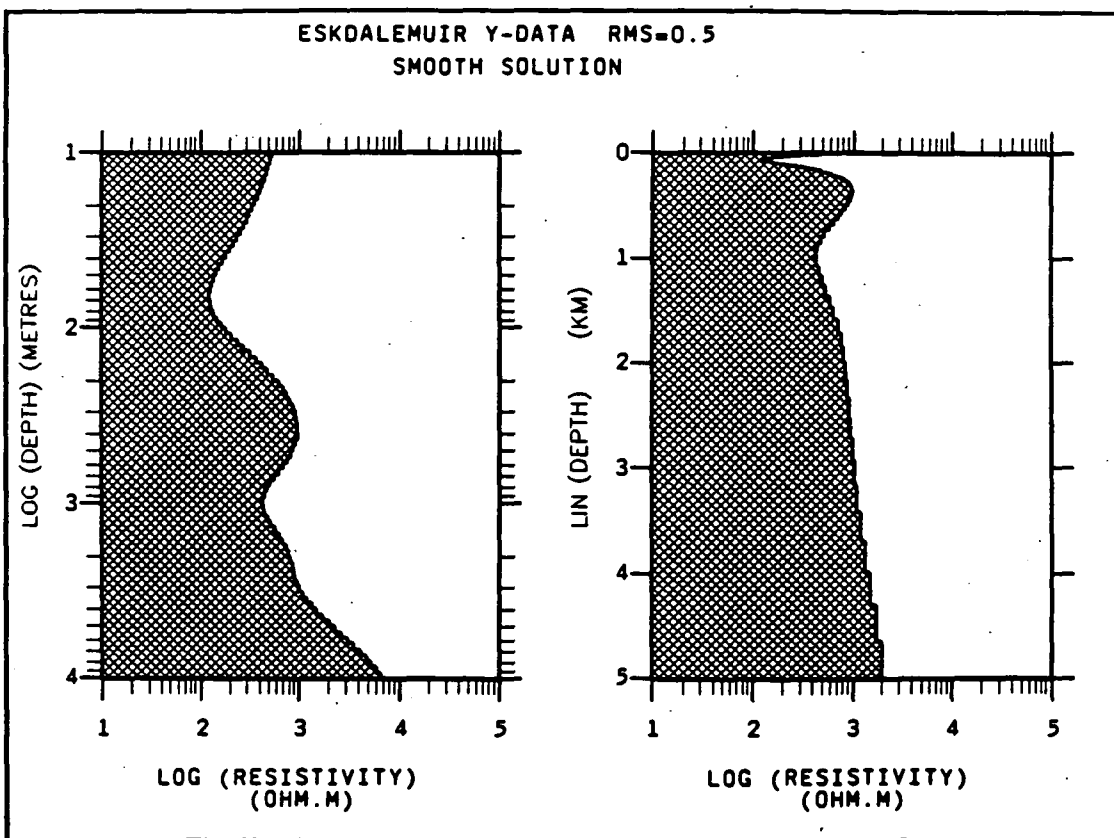
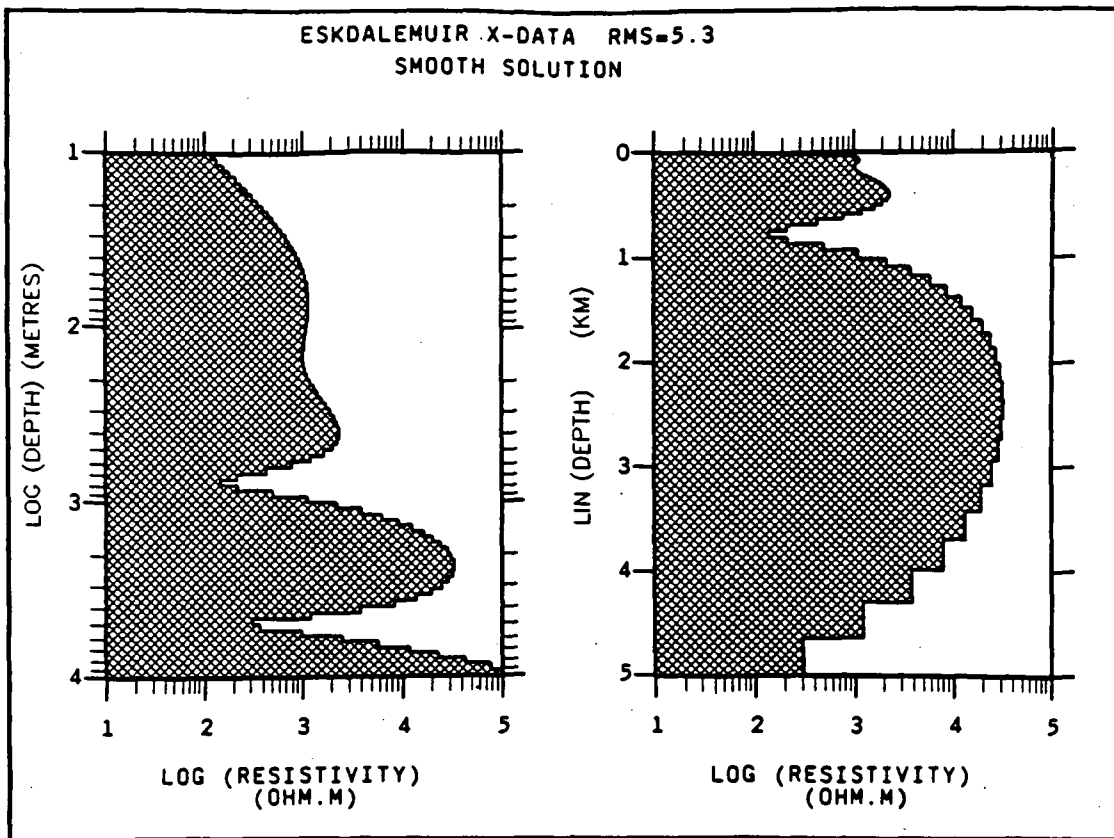

FIGURE 11. Smooth inverse solutions to the data at Eskdalemuir. Logarithmic (left) and linear (right) depth scales.

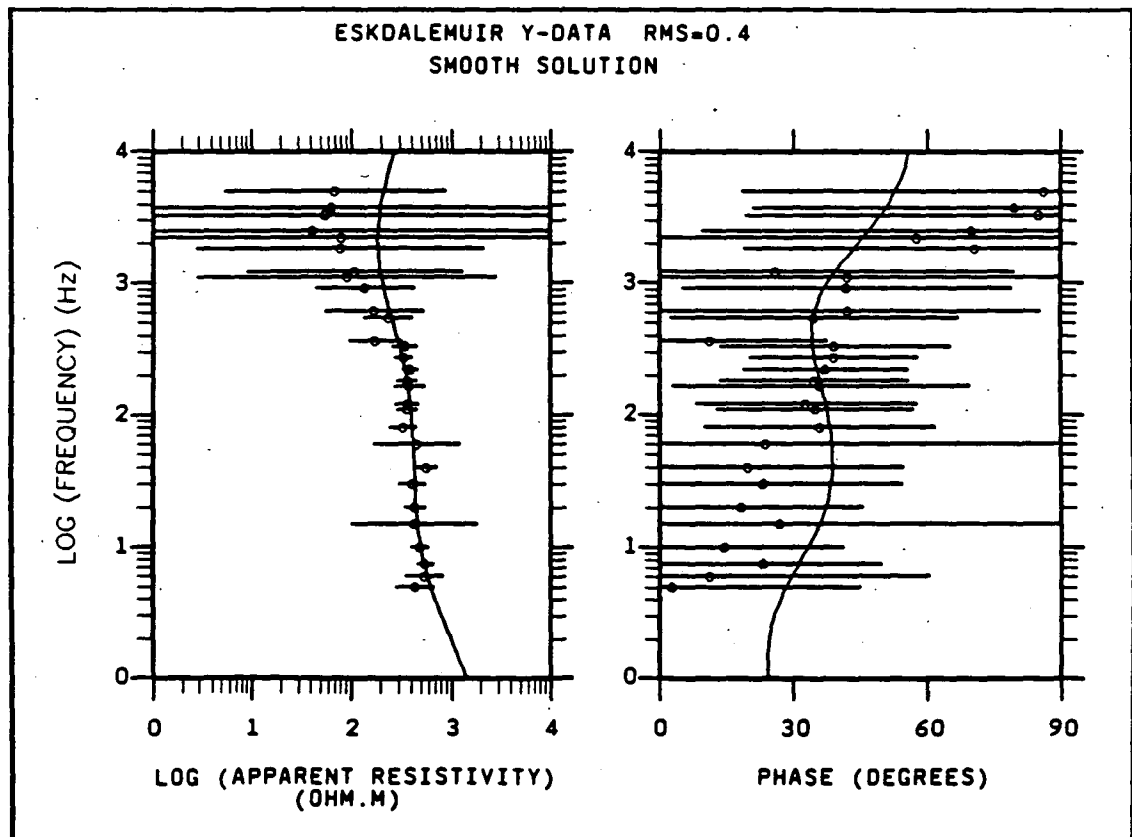
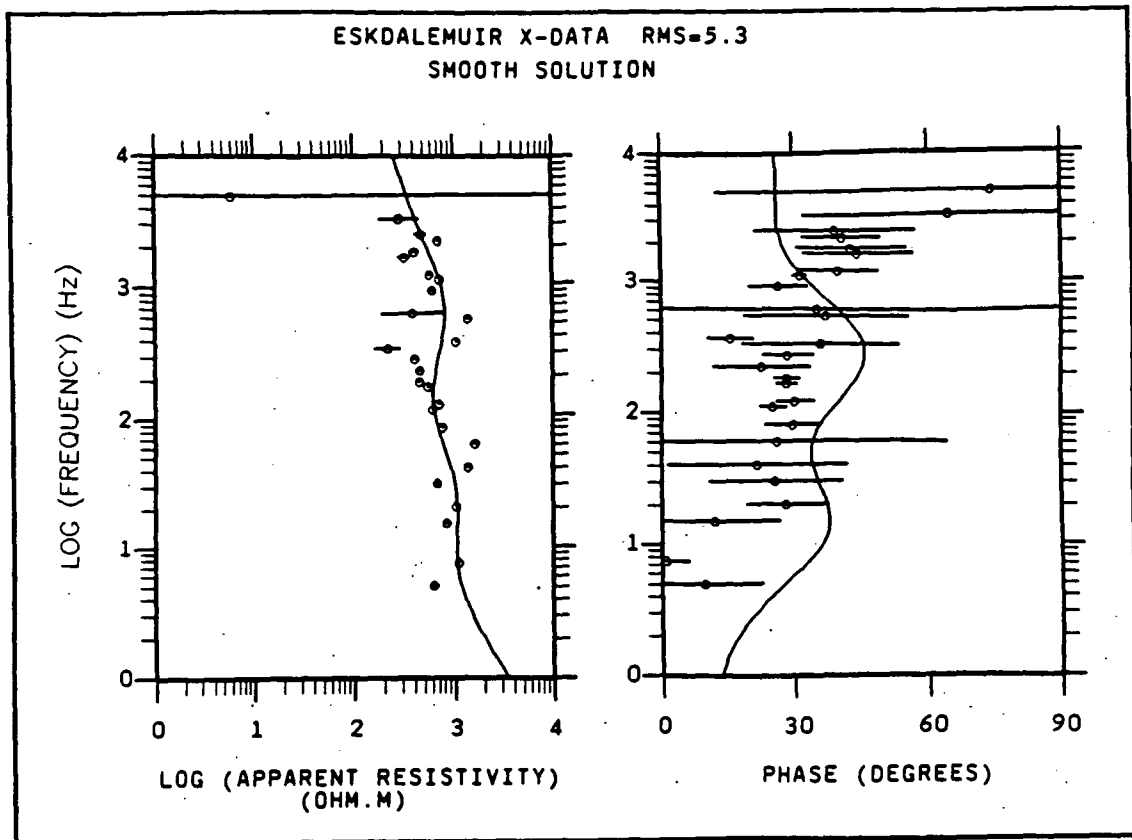

FIGURE 12. Fit of the inverse solutions of Fig. 11 to the data at Eskdalemuir.

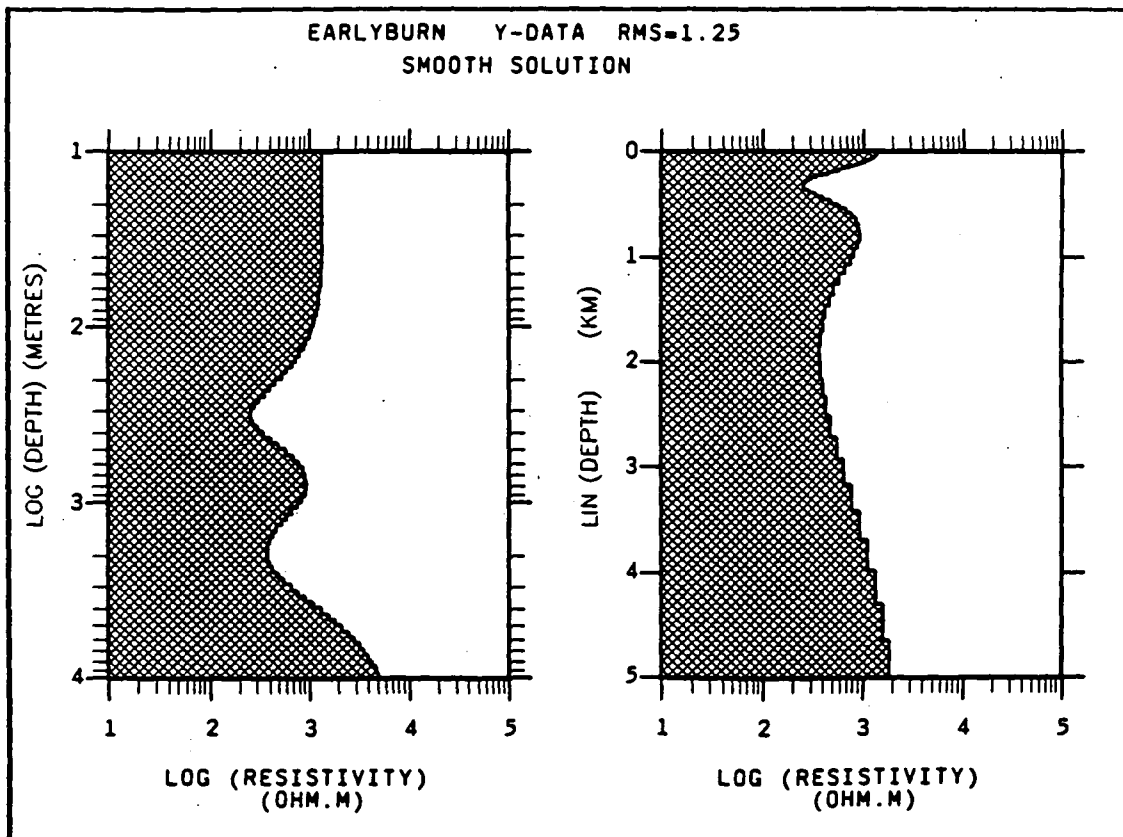
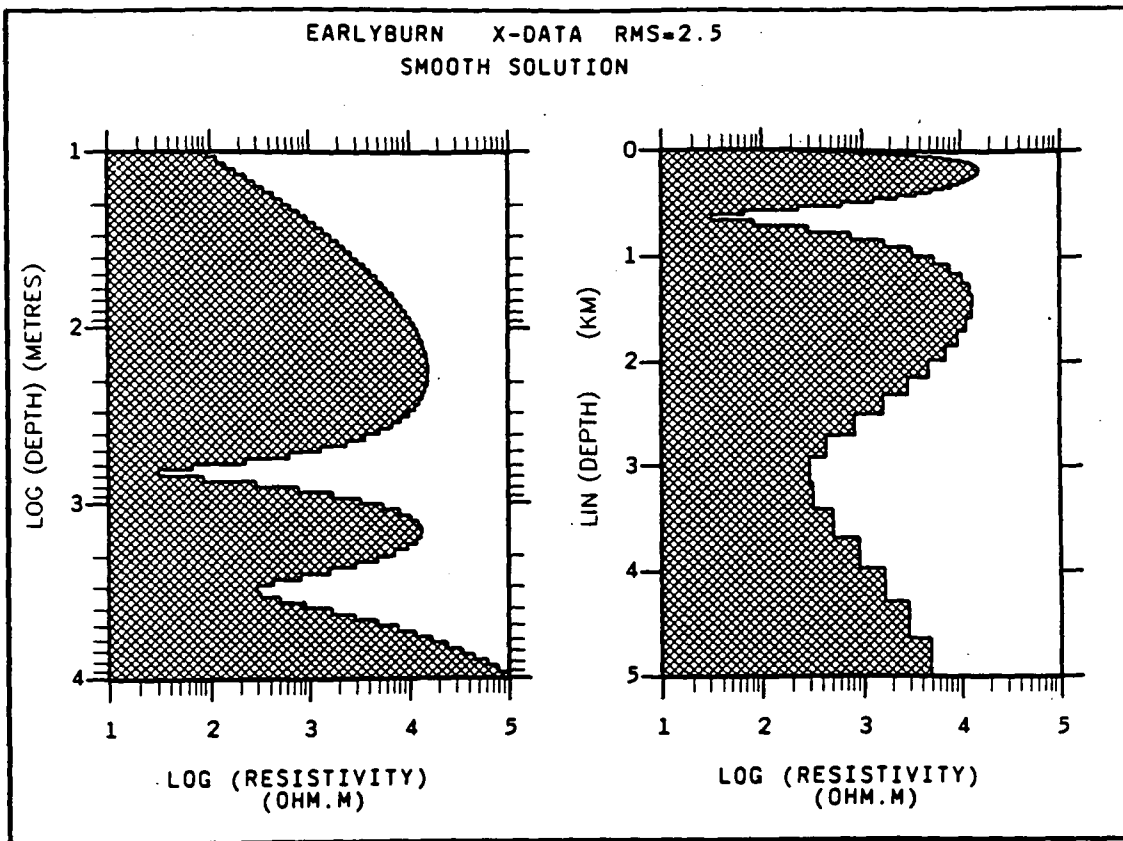

FIGURE 13. Smooth inverse solutions to the data at Earlyburn. Logarithmic (left) and linear (right) depth scales.

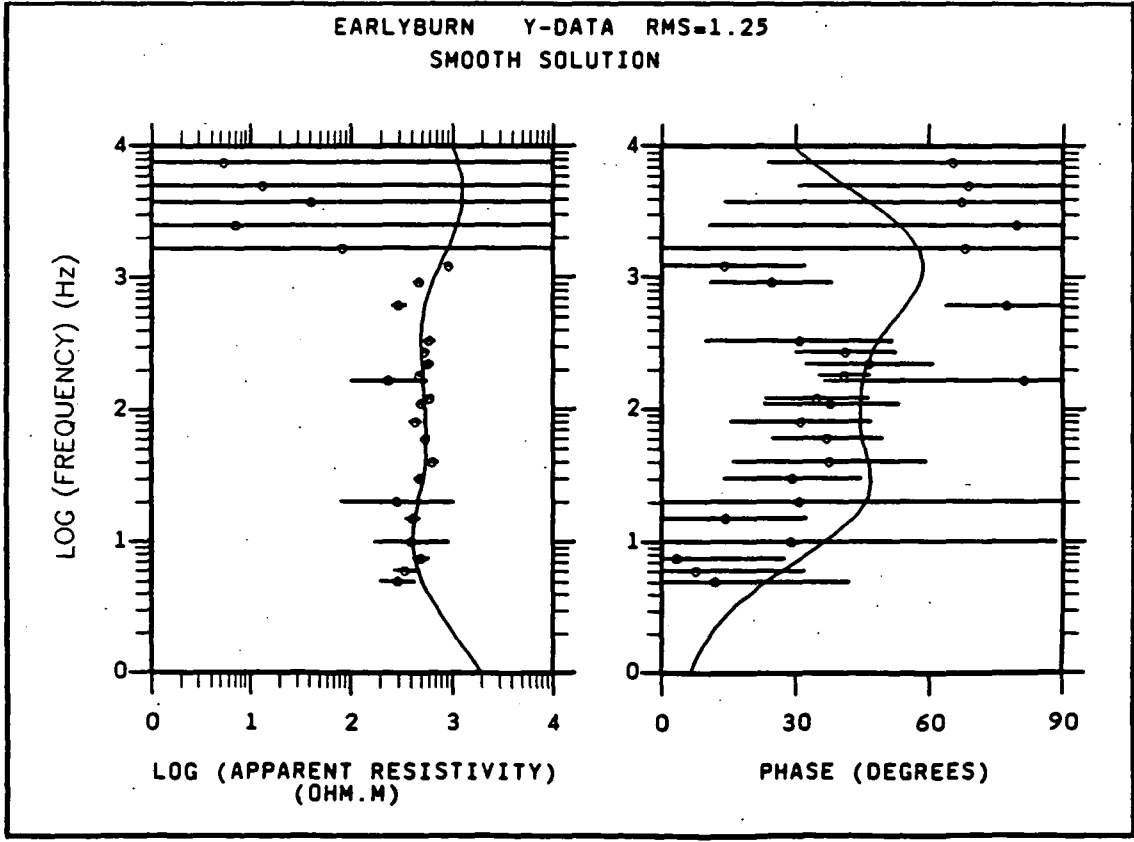
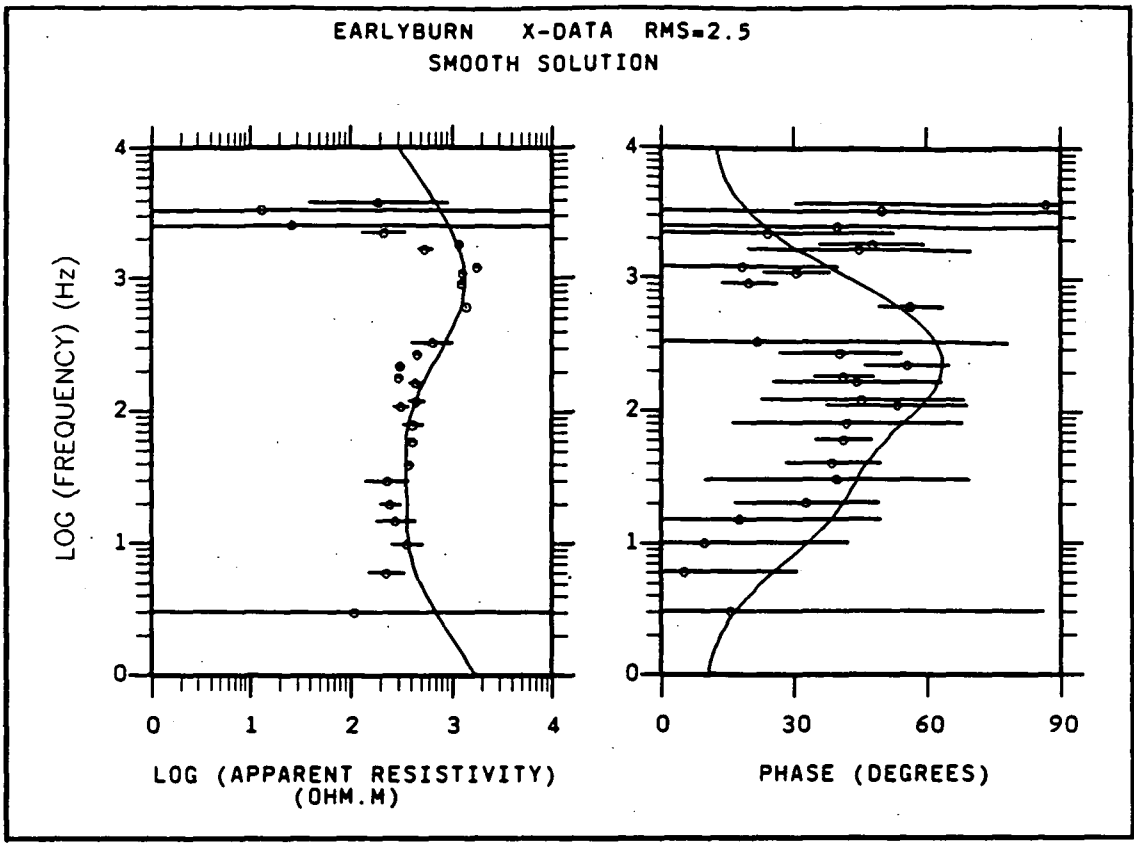

FIGURE 14. Fit of the inverse solutions of Fig. 13 to the data at Earlyburn.

APPENDIX A

Four page brochure describing the BRGM SAMTEC1 system.

SAMTEC 1

AUDIO
MAGNETOTELLURICS
RESISTIVITY-
METER

- * EASE OF USE
- * QUALITY AND SPEED OF MEASUREMENT
- * ACQUISITION IN A WIDE FREQUENCY RANGE

Backed by twenty years experience in the design of electromagnetic instruments, BRGM introduces SAMTEC 1, a scalar audiomagnetotellurics resistivitymeter operating in the wide frequency range 1 Hz-7 500 Hz.

A microprocessor controls the acquisition, processing, display and storage of data. Apparent resistivity and quality coefficient values are continuously displayed to give real-time information to the operator.

SAMTEC 1 can be used either through a fully automatic procedure (automatic ranging and stacking, preset frequencies) or through a manual mode where the operator keeps the full control of the acquisition.

Its ease of use and quality of measurement make SAMTEC 1 an efficient alternative to long lines electrical soundings, and a powerful tool in deep exploration surveys for mining applications, groundwater investigations, geothermal exploration, structural studies...



BRGM Instruments

B.P. 6009
45060 ORLÉANS CEDEX 2 - FRANCE
Tél.: (33) 38.64.34.18
Télex : BRGM 780258 F



EASE OF USE

In the automatic mode of SAMTEC 1, the operator just has to introduce the station number, the number of stacks to be carried out or the minimum quality of the measurement to be reached - default values are available - and then the start key: filtering, gain ranging and frequency scanning are automatic. Ten frequencies per decade are analyzed, thirty six frequencies in the whole frequency range. When several cycles of measurement are asked at the same station, data storage is automatic at the end of each cycle and the measurement goes on automatically. The internal memory can store up to 780 measurements which correspond to 21 frequency soundings. After the operator has set up the grounded electric line and the magnetic sensor, a complete sounding can be carried out in less than ten minutes, in good signal conditions. Although the measurement is fully digital, an external visualization unit including two galvanometers is available to enable the operator to check the amplitude variations of the electric and magnetic fields.

QUALITY OF PROCESSING

The second keypoint of a MT system is the efficiency of its measuring process. In SAMTEC 1 receiver, filtering is performed digitally through a Fourier Transform computation. For each frequency, F , keyed-in in the manual mode, four frequencies are analyzed simultaneously: F , $1.5F$, $2F$, $3F$. A specific processing is proposed for higher frequencies where natural signals are sometimes very weak: the operator can choose to process either the whole rough signals acquired, or just among them the high level signals (peaks which can sometimes lead to better quality measurements).

Stacking of measurements is carried out according to a selective process: electric/magnetic fields ratios are averaged through weight coefficients which depend either on the coherency between the electric and the magnetic fields, or on the standard deviation of the resistivity. This weighted stacking permits to lower the influence of a noisy measurement which is not supposed to correspond to a MT signal. A good quality measurement is reached in a shorter time through such a procedure than when using a classical average of signals.

A quality coefficient - between 0 and 100% - depending on the coherency of the fields and the standard deviation of their ratio is displayed at each measurement, with the apparent resistivity value: the operator is informed in real time of the quality of the measurement.

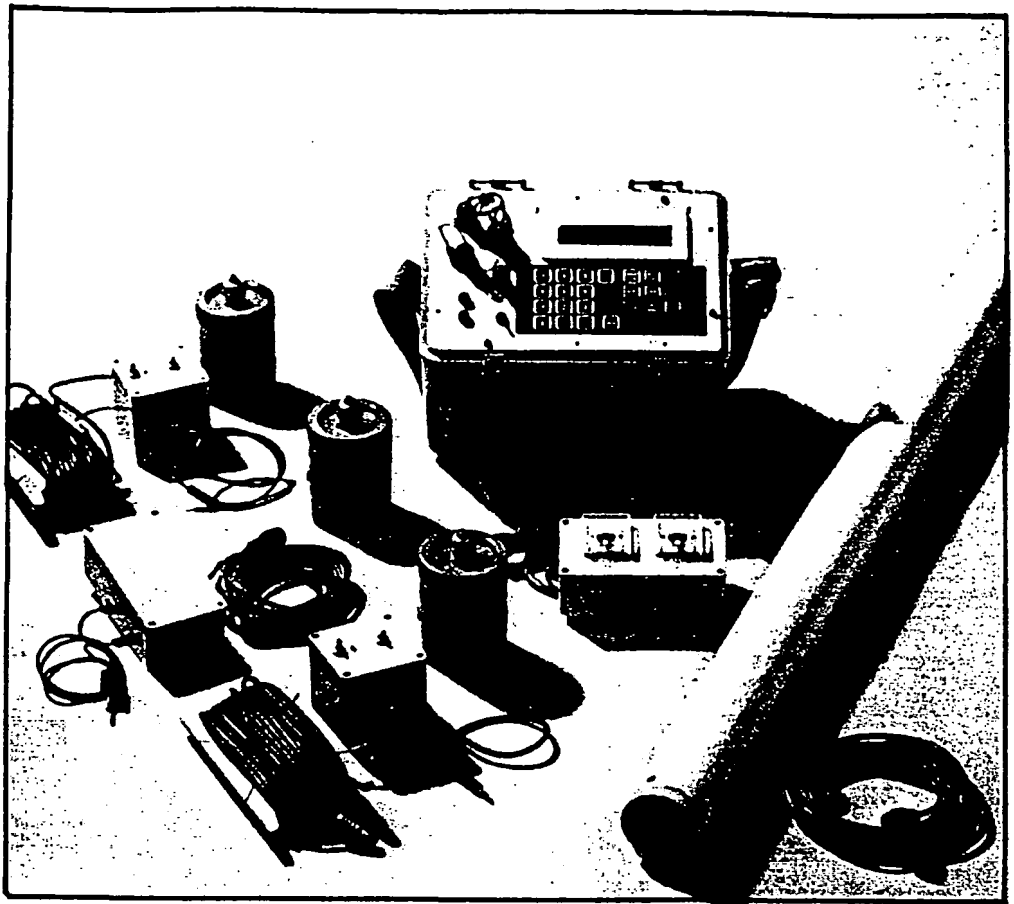
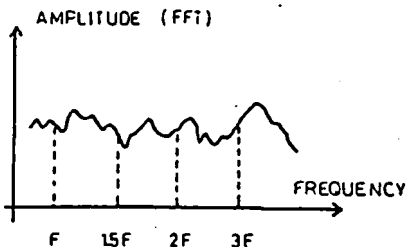

SAMTEC 1 RECEIVER
WITH ELECTRIC LINE AND MAGNETIC SENSOR

QUALITY OF SENSORS

Because the MT natural signals have generally low amplitudes, the first keypoint of a MT system is the low internal noise that its sensors are required to have. SAMTEC 1 has been designed with highly efficient sensors, both for the electric and the magnetic fields measurements.

The electric line consists in three non polarizable electrodes, two electrode preamplifiers, two 10 m long low noise special cables and one differential preamplifier: the total internal noise of this electric line is lower than 50 nV/√Hz from 10 Hz to 7 500 Hz.

The magnetic sensor consists in a flux feed back coil, with a flat induction response of 100 mV/γ from 2 Hz to 7 500 Hz and an internal noise - measured in a shielded case - lower than 2 μγ/√Hz at higher frequencies. Calibration coefficients of the magnetic sensors are stored in ROM and automatically taken into account during the data processing.

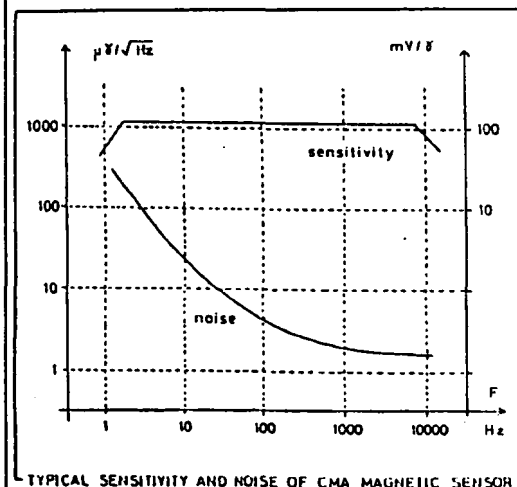

TYPICAL SENSITIVITY AND NOISE OF CMA MAGNETIC SENSOR

SPECIFICATIONS

- Two simultaneous measuring channels : electric field (E), magnetic field (H),
- Frequency range : 1Hz to 7500 Hz,
- Very large choice of frequencies,
- Four simultaneous frequency measurements (F, 1.5F, 2F, 3F);
- Automatic cycle for measurements in the whole frequency range,
- Visualization of E and H signals through galvanometers,
- Analogical outputs,
- Automatic and manual gain ranging,
- Digital data processing : Fourier Transform and cross spectra ; coherence and standard deviation parameters ; real time display of resistivity and quality coefficient ; phase measurement between electric and magnetic field,
- Data storage in internal memory : 780 records,
- RS-232C port for transferring data into a microcomputer,
- Differential measurement for electric field ; non polarizable electrodes with low noise preamplifiers,
- Magnetic sensor (CMA) : frequency range : 1 Hz-7 500 Hz, length : 1 m (2'8"), diameter : 9 cm (3" 9/16), weight : 7 kg (22 lb).

GENERAL FEATURES

- Dimensions : 22 x 31 x 33 cm (9 x 12 x 13 in),
- Weight : 8 kg (18 lb),
- Operating temperature range : -20°C to +50°C,
- Power supply : nine 1.5V D size dry cells or 12V external battery.

INTERPRETATION SOFTWARE

GRIMTI is a software for the interpretation of AMT or MT soundings with layered models (1D geoelectrical section). It permits the forward computation of theoretical sounding curves, and automatic fitting of parameters. Data can be introduced manually from the computer keyboard or directly from SAMTEC 1 using the standard RS-232C serial link. Interpretation is fully controlled by the operator through the computer screen ; final document is a plot of field data and a theoretical curve corresponding to the proposed 1D model. GRIMTI is available on PC or compatible and on HP 9000 (series 200, 300) microcomputers.

HARDWARE REQUIREMENTS

(PC version)

- IBM-PC, XT or AT or PC compatible (COMPAQ, BULL-MICRAL, OLIVETTI...)
- 512 Kbytes RAM
- CGA or EGA compatible graphics card
- HPGL serial plotter
- Centronics port with optional printer
- MS-DOS 2.1+

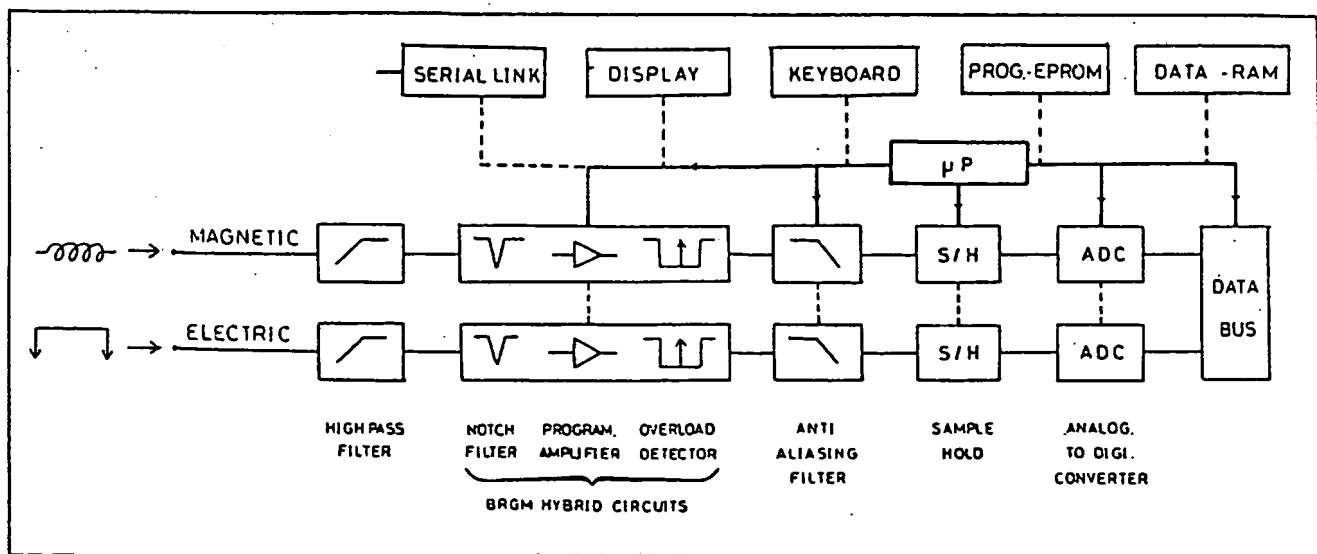

SAMTEC1 SCHEMATIC DIAGRAM

AUDIOMAGNETOTELLURICS

Magnetotellurics is a geophysical exploration method that aims at detecting the depths and resistivities of underground layers. It is based on the analysis of the fluctuations of natural electric and magnetic fields at the surface of the ground. These fields induce electric currents into the earth, the intensities of which depend on the resistivities of the layers. According to EM laws, the lower the frequency, the deeper the investigation. The lowest frequencies of the Audio range (about 1 Hz) correspond to a depth of investigation of several hundreds meters in a medium resistivity environment. The difficulty of measuring natural signals at higher frequencies has been limiting for a long time the use of AMT in shallow exploration. This drawback is now being reduced thanks to the improvements of the quality of the field sensors and of the data processing.

AUDIOMAGNETOTELLURIC SOUNDINGS ON A CALDERA

(France)

The volcanic complex of SANCY - Mont Dore (2.5-1.5 M. years) was recently studied by a combined geological, petrological, and geochemical approach. Historically, it is interpreted as a resurgent dome due to the settling of a magmatic chamber, followed by a subsidence of the upper part of the dome.

The general structure is a radial set of blocks, organized from the surface as alternating lave and pumice levels ; the geothermal fluids principally occur in the latter.

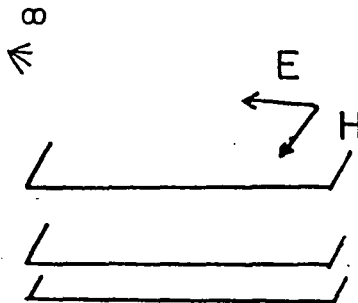

Scalar audiomagnetotelluric data have been acquired with SAMTEC 1 (frequency range : 1-7500 Hz) along a 10 km long profile, at right angle to the main faults. Schlumberger electrical soundings (AB = 800-1000m) were carried out close to the AMT stations.

The figures below show tabular interpretation of both sounding types. The interpretation of electrical soundings - zero to 150 m deep - fits quite well on the AMT data, which provide information from 40 to 1800 m depth, with a significant time saving.

In agreement with the geological knowledge, interpretation shows alternating resistive and conductive layers (lavas and pumice). The last resistive layer corresponds to the granitic substratum.

B.R.C.M. des Géophysiques

Résistivité (ohm.m)	Profondeur (m)
∞	0.000
550.000	.300
2000.000	0.000
700.000	40.000
50.000	75.000
800.000	120.000
30.000	

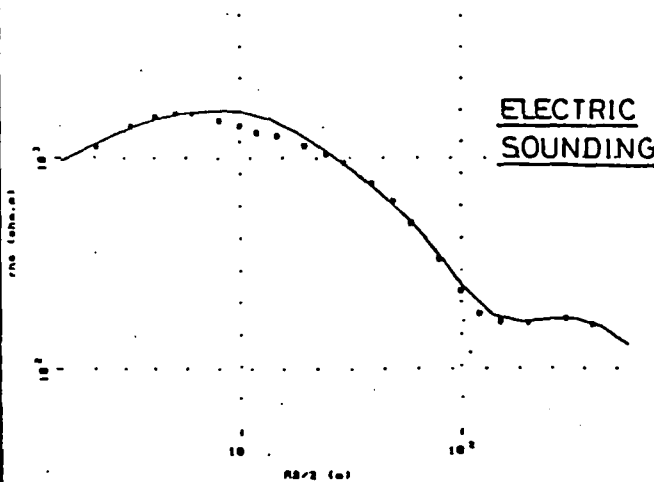

• BRGM/CMH • CRIVEL •

Schlumberger

Mont Dore - SCALAR AMT SAMTEC 1

Résistivité (ohm.m)	Profondeur (m)
∞	0.000
550.000	.300
2000.000	0.000
700.000	40.000
50.000	75.000
800.000	120.000
30.000	130.000
250.000	210.000
30.000	1670.000
1000.000	1800.000

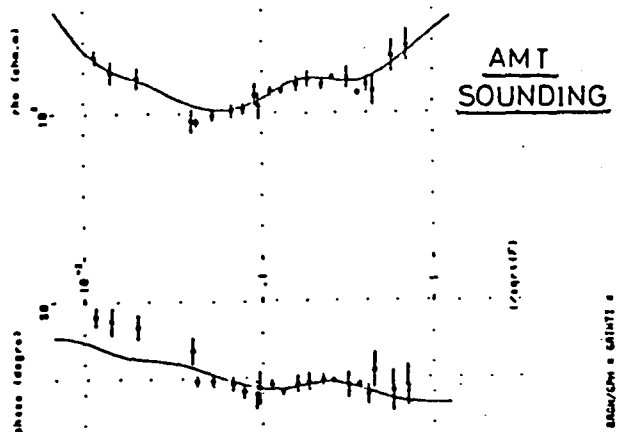

Electrical sounding
AB = 800m

Scalar AMT sounding
Freq. = 7500 - 2Hz

• BRGM/CMH • CRIVEL •

Interpretation of electrical data and scalar AMT sounding

APPENDIX B

Listing of field sounding 'records' held in the SAMTEC1 unit obtained at Eskdalemuir (sounding 3, E-W component).

The first number (preceeding the >) is the internal record number. The first column displayed is the station or sounding number. The second column is the frequency in hertz. The third and fourth columns contain the data. Column 3 displays phase in degrees and column 4 displays the apparent resistivity in ohm.m. The final two columns contain the estimated data errors. Column 5 contains the standard deviation of the phase in degrees and column 6 contains the standard deviation of apparent resistivity expressed as a *percentage*.

SOUNDING 3 consists of 3 measurement cycles (automatic mode) of E-W data at Eskdalemuir. Initial data records are 'trial' data (manual mode) obtained prior to the collection of automatic mode data.

Date : 6/11/89

n°	variable	unité	format
1	station		F5.0
2	F	hertz	F8.3
3	phase	.	F7.2
4	rho~a	ohm.m	F10.1
5	SD(phase)	.	F7.2
6	SD(rho~a)	%	F5.1

3 / St. 3

53 >	3	2000	-87.39	795.7	70.61	568.2
54 >	3	3000	-108.5	661.5	72.23	624.2
55 >	3	4000	-124.77	1736.9	55.48	290.8
56 >	3	6000	15.15	867.5	52.58	261.4
57 >	3	7	-6.06	509.7	78.75	1005.4
58 >	3	10.5	1.76	487.3	32.58	127.8
59 >	3	14	28.72	733.4	22.25	81.8
60 >	3	21	26.15	411.3	25.07	93.5
61 >	3	2	7.77	425.1	26.45	99.5
62 >	3	3	-31.4	298.3	43.82	191.9
63 >	3	4	-5.19	203.3	65.93	447.8
64 >	3	6	18.17	551.6	30.5	117.8
65 >	3	5.001	-8.08	661.4	53.63	271.6
66 >	3	7.502	22.48	784.7	9.76	34.4
67 >	3	10	21.85	466.4	16.09	57.7
68 >	3	15	24.77	337	25.49	95.4
69 >	3	10	5.32	355.4	31.82	124.1
70 >	3	15	28.26	766	30.62	118.4
71 >	3	20	42.97	485.9	51.09	247.8
72 >	3	30	22.77	287.5	22.1	81.2
73 >	3	40	27.13	612.1	29.48	113.1
74 >	3	60	33.14	416.1	28.44	108.3
75 >	3	80	33.87	344	27.12	102.4
76 >	3	120	36.2	422.6	19.03	69
77 >	3	109.9	24.97	686.2	10.71	37.8
78 >	3	164.9	36.54	452	10.63	37.5
79 >	3	219.9	6.67	1597.2	54.17	277
80 >	3	329.9	37.94	238.2	12.22	43.3
81 >	3	179.9	27.98	257.1	8.85	31.1
82 >	3	269.9	42.38	160.9	23.91	88.7
83 >	3	359.9	10.74	164.3	8.26	29
84 >	3	539.9	66.91	44	30.17	116.3
85 >	3	609.7	37.18	115.6	47.91	221.4
86 >	3	914.6	41.57	273.8	11.6	41
87 >	3	1219	45.61	184.6	25.68	96.2
88 >	3	1829	99.63	9.6	61.37	366.4
89 >	3	1101	36.29	83	71.43	595.2
90 >	3	1651	108.56	2.2	83.22	1681.6
91 >	3	2202	-12.23	3.6	71.43	595.2
92 >	3	3303	134.93	.5	85.57	2580
93 >	3	2500	-2.78	19.8	64.48	419
94 >	3	3750	117.48	.5	83.88	1866
95 >	3	5000	131.48	3.1	86.65	3414
96 >	3	7500	111.33	43.3	30.73	118.9
97 >	3	2	-25.91	648.1	39.98	167.7
98 >	3	3	-19.02	810.5	34.68	138.4
99 >	3	4	2.03	493.8	57.51	314
100 >	3	6	23.8	802.5	26.98	101.8
101 >	3	5.001	68.68	576.1	86.25	3054

102 >	3	7.502	28.13	922.1	17.1	61.5
103 >	3	10	1.32	446	35.04	140.3
104 >	3	15	16.94	826	20.77	75.9
105 >	3	10	7.19	651.4	34.51	137.5
106 >	3	15	30.92	337.9	25.49	95.3
107 >	3	20	30.15	395.5	40.14	168.6
108 >	3	30	10.2	757.5	22.77	84
109 >	3	40	18.55	464.7	43.46	189.5
110 >	3	60	38.78	548.9	17.09	61.5
111 >	3	80	51.58	425.9	30.46	117.6
112 >	3	120	40.57	445.4	14.42	51.4
113 >	3	109.9	31.51	307.5	16.52	59.3
114 >	3	164.9	29.24	350.5	7.42	26.1
115 >	3	219.9	31.97	392.6	11.4	40.3
116 >	3	329.9	52.05	203.7	21.29	77.9
117 >	3	179.9	34.9	348.1	8.61	30.3
118 >	3	269.9	32.38	348.4	6.02	21.1
119 >	3	359.9	12.2	161.5	3.89	13.6
120 >	3	539.9	56.83	32.3	48.64	227.2
121 >	3	609.7	6.25	82.8	67.11	473.8
122 >	3	914.6	38.47	165.6	29.03	111
123 >	3	1219	34.28	111.7	26.53	99.9
124 >	3	1829	96.27	32.8	58.12	321.6
125 >	3	1101	60.86	5.5	80.51	1196.8
126 >	3	1651	114.02	60.1	75.41	768.2
127 >	3	2202	178.53	7.8	78.16	954.4
128 >	3	3303	79.96	42.6	57.32	311.8
129 >	3	2500	9.42	1031.7	57.15	309.8
130 >	3	3750	125.54	7.7	68.12	498
131 >	3	5000	156.14	44.6	80.19	1156.2
132 >	3	7500	123.79	52	50.71	244.4
133 >	3	2	-23.48	1144.5	53.97	275
134 >	3	3	-15.29	825.7	19.91	72.4
135 >	3	.4	-6.55	672.6	41.21	175.1
136 >	3	6	16.09	914.6	24.08	89.4
137 >	3	5.001	1.23	1326.4	38.23	157.5
138 >	3	7.502	23.77	874.6	16.79	60.3
139 >	3	10	24.86	398.8	28.93	110.5
140 >	3	15	12.96	728.7	30.42	117.4
141 >	3	10	-.82	479.7	35.78	144.2
142 >	3	15	20.89	787.4	23.22	85.8
143 >	3	20	8.49	475.8	64.01	410.2
144 >	3	30	20.64	349.3	29.53	113.3
145 >	3	40	49.31	777.7	56.2	298.8
146 >	3	60	25.32	864.2	45.9	206.4
147 >	3	80	35.75	464.5	18.24	65.9
148 >	3	120	30.24	494.6	12.07	42.8
149 >	3	109.9	32.28	515.4	8.67	30.5
150 >	3	164.9	33.56	451.9	6.08	21.3
151 >	3	219.9	37.63	290	13.62	48.5
152 >	3	329.9	47.97	257.8	8.56	30.1
153 >	3	179.9	29.46	339.6	26.24	98.6
154 >	3	269.9	38.03	422.8	28.99	110.8
155 >	3	359.9	3.35	249.2	10.18	35.9
156 >	3	539.9	.91	64	54.79	283.4
157 >	3	609.7	34.68	63.3	77.2	880.6
158 >	3	914.6	32.34	142.6	23.8	88.2
159 >	3	1219	28.69	196.7	33.02	130
160 >	3	1829	55.02	10.6	77.92	934.4
161 >	3	1101	20.49	89.7	59.87	344.6
162 >	3	1651	19.32	2.5	87.74	5072
163 >	3	2202	45.99	17.6	54.88	284.4
164 >	3	3303	129.56	24.2	38.38	158.4
165 >	3	2500	-21.83	17.9	81.51	1339.8
166 >	3	3750	92.62	3.5	88.78	9418
167 >	3	5000	80.8	18.8	49.21	231.8
168 >	3	7500	100.75	67.3	43.61	190.5