



**British
Geological Survey**

NATURAL ENVIRONMENT RESEARCH COUNCIL

Final Report of FORGE WP3.1.1: The large scale gas injection test (Lasgit) performed at the Äspö Hard Rock Laboratory

Minerals and Waste Programme

Commissioned Report CR/12/141



BRITISH GEOLOGICAL SURVEY

MINERALS AND WASTE PROGRAMME

COMMISSIONED REPORT CR/12/141

Final Report of FORGE WP3.1.1: The large scale gas injection test (Lasgit) performed at the Äspö Hard Rock Laboratory

R.J. Cuss, J.F. Harrington, D.J. Noy, and C.C. Graham

Keywords

Lasgit, gas injection, bentonite, modelling, hydration, hydraulic, storage, gas entry pressure.

Front cover

View of the Lasgit experiment conducted at 420m depth at the Äspö Hard Rock Laboratory.

Bibliographical reference

CUSS, R.J., HARRINGTON, J.F., NOY, D.J., and GRAHAM, C.C. 2012. Final Report of FORGE WP3.1.1: The large scale gas injection test (Lasgit) performed at the Äspö Hard Rock Laboratory. *British Geological Survey Commissioned Report*, CR/12/141. 31pp.

Copyright in materials derived from the British Geological Survey's work is owned by the Natural Environment Research Council (NERC) and/or the authority that commissioned the work. You may not copy or adapt this publication without first obtaining permission. Contact the BGS Intellectual Property Rights Section, British Geological Survey, Keyworth, e-mail ipr@bgs.ac.uk. You may quote extracts of a reasonable length without prior permission, provided a full acknowledgement is given of the source of the extract.

© NERC 2012. All rights reserved

Keyworth, Nottingham British Geological Survey 2012

BRITISH GEOLOGICAL SURVEY

The full range of our publications is available from BGS shops at Nottingham, Edinburgh, London and Cardiff (Welsh publications only) see contact details below or shop online at www.geologyshop.com

The London Information Office also maintains a reference collection of BGS publications, including maps, for consultation.

We publish an annual catalogue of our maps and other publications; this catalogue is available online or from any of the BGS shops.

The British Geological Survey carries out the geological survey of Great Britain and Northern Ireland (the latter as an agency service for the government of Northern Ireland), and of the surrounding continental shelf, as well as basic research projects. It also undertakes programmes of technical aid in geology in developing countries.

The British Geological Survey is a component body of the Natural Environment Research Council.

British Geological Survey offices

BGS Central Enquiries Desk

Tel 0115 936 3143 Fax 0115 936 3276
email enquires@bgs.ac.uk

Kingsley Dunham Centre, Keyworth, Nottingham NG12 5GG

Tel 0115 936 3241 Fax 0115 936 3488
email sales@bgs.ac.uk

Murchison House, West Mains Road, Edinburgh EH9 3LA

Tel 0131 667 1000 Fax 0131 668 2683
email scotsales@bgs.ac.uk

London Information Office at the Natural History Museum (Earth Galleries), Exhibition Road, South Kensington, London SW7 2DE

Tel 020 7589 4090 Fax 020 7584 8270
Tel 020 7942 5344/45 email bgs london@bgs.ac.uk

Columbus House, Greenmeadow Springs, Tongwynlais, Cardiff CF15 7NE

Tel 029 2052 1962 Fax 029 2052 1963

Forde House, Park Five Business Centre, Harrier Way, Sowton EX2 7HU

Tel 01392 445271 Fax 01392 445371

Maclean Building, Crowmarsh Gifford, Wallingford OX10 8BB

Tel 01491 838800 Fax 01491 692345

Geological Survey of Northern Ireland, Colby House, Stranmillis Court, Belfast BT9 5BF

Tel 028 9038 8462 Fax 028 9038 8461

www.bgs.ac.uk/gsni/

Parent Body

Natural Environment Research Council, Polaris House, North Star Avenue, Swindon SN2 1EU

Tel 01793 411500 Fax 01793 411501
www.nerc.ac.uk

Website www.bgs.ac.uk

Shop online at www.geologyshop.com

Foreword

This report is the product of a study by the British Geological Survey (BGS) undertaken on behalf of the Swedish radioactive waste management company Svensk Kärnbränslehantering AB (SKB) and the European Union 7th Framework Euratom Programme under the auspices of the Fate of Repository Gases (FORGE) project, to examine the fate of gas in a full-scale KBS-3 mock-up under realistic in situ conditions.

Acknowledgements

This study was undertaken by staff from the British Geological Survey (Radioactive Waste Team). Funding for the study was provided by SKB (Stockholm), the British Geological Survey and the European Commission through the FORGE (Fate of Repository Gases) and NF-PRO (Understanding and physical and numerical modelling of the key processes in the near-field, and their coupling, for different host rocks and repository strategies) projects undertaken within the auspices of the EURATOM 7th and 6th framework programmes respectively.

The authors would like to thank Patrik Sellin for his support of the research area, SKB colleagues at the Äspö Hard Rock Laboratory for their help in the set-up, maintenance and operation of the Lasgit experiment, colleagues at Clay Technology AB who were responsible for the original installation of the Geokon instrumentation and buffer clay, and the skilled staff of the Research & Development Workshops at the BGS, in particular Humphrey Wallis and Steve Upton, for their design and construction of the gas injection ports.

Contents

Foreword	2
Acknowledgements	2
Contents	3
Executive summary	5
1 Introduction	6
1.1 Rationale	6
1.2 Objectives	6
2 Experimental set-up	7
3 Results	10
3.1 Gas injection test 1 (Day 813 – 1110) [pre-FORGE]	10
3.2 Gas injection test 2 (Day 1430 – 2064)	12
3.3 Gas injection test 3 (Day 2257 – 2614)	17
3.4 Stress and gas peak pressure	22
4 Hydration of the bentonite buffer over a seven year period	24
5 Conclusions	27
References	28

FIGURES

Figure 2-1 - A panoramic view of the Lasgit test site located 420m below ground at the Äspö Hard Rock Laboratory in Sweden.....	7
Figure 2-2 - Schematic of the layout of the Lasgit experiment showing the locations of sensors.....	8
Figure 3-1 - Plots [A] and [B] show the entire injection history for Gas test 1	11
Figure 3-2 - Plots [A] and [B] show the entire injection history for Gas test 2	13
Figure 3-3 - Data from deposition hole instrumentation before and after major gas entry at Day 1766.55	15
Figure 3-4 - Data showing prolonged gas injection in FL903	16
Figure 3-5 – Gas migration direction for the three gas injection tests.	18
Figure 3-6 – Plot [A] shows the entire injection history for Gas test 3.....	19
Figure 3-7 – Response of radial stress and porewater pressure on the deposition hole wall at the time of gas breakthrough.....	20
Figure 3-8 – Response of selected sensors during prolonged gas injection.....	21
Figure 3-9 – Response of selected sensors in detail during prolonged gas injection and for the leak-off test	22
Figure 3-10 – Gas breakthrough and local stress	23

Figure 4-1 – The evolution of pressure and stress within Lasgit over the complete life-time of the experiment..... 24

Figure 4-2 – The evolution of permeability within Lasgit over the complete life-time of the experiment..... 26

TABLES

Table 2-1 List of test stages during the complete history of Lasgit 9

Executive summary

This report summarises the set-up, operation and observations from the first 2890 days (7.9 years) of the large scale gas injection test (Lasgit) experiment conducted at the Äspö Hard Rock Laboratory. During this time the bentonite buffer has been artificially hydrated and has given new insight into the evolution of the buffer.

Three gas injection tests have been conducted during the duration of Lasgit. The first two tests were conducted in the lower array of injection filters at FL903. Both of these tests showed similar behaviour with a well-defined pressure peak; spontaneous negative transient; evidence of dynamic behaviour and unstable gas pathways; asymptote close to stress. The results were remarkably qualitatively similar to the laboratory test results. However, the high gas entry pressures seen in the laboratory were not seen in Lasgit as stress state is much lower due to non-complete hydration of the buffer and the expansion of the buffer to fill construction voids. The third gas test was conducted in an upper array filter (FU910). The response at the time of gas peak pressure was subtly dissimilar to that seen at FL903 with two peak pressures.

Lasgit has confirmed the coupling between gas, stress and pore-water pressure for flow before and after major gas entry at the field scale. All observations suggest mechanisms of pathway propagation and dilatancy predominate. In all three gas tests the propagation was through localised features and the general movement direction was towards the bottom of the deposition hole in the direction of the prevailing stress gradient. The injection tests have shown that the interface between barriers is a key part of the system. Gas appears to have exited the deposition hole in Gas test 2, but failed to find a way out during Gas test 3; where gas continued to migrate along the canister/buffer interface.

Throughout the history of Lasgit parts of the system have been artificially and naturally hydrated. Hydraulic results, from controlled and uncontrolled events, show that the buffer continues to mature and has yet to reach full maturation. Hydration of the clay is progressing well but sections of bentonite remain in suction and in hydraulic disequilibrium.

1 Introduction

1.1 RATIONALE

In the Swedish KBS-3 disposal concept (SKB TR-09-22), copper/steel canisters containing spent nuclear fuel will be placed in large diameter disposal boreholes drilled into the floor of the repository tunnels. The space around each canister will be filled with pre-compacted bentonite blocks which, over time, will draw in the surrounding groundwater and swell, closing any construction gaps. Once hydrated, the bentonite will act as a low permeability diffusional barrier, severely limiting the migration of any radionuclides released from a canister after closure of the repository. While the waste canisters are expected to have a very substantial lifespan within the repository environment, it is important for purposes of performance assessment to consider the impact of groundwater penetration of one of the canisters. Under certain repository conditions, corrosion of the steel inner will lead to the formation of hydrogen gas. Radioactive decay of the waste and the radiolysis of water will produce additional gas within the container void. Depending on the rate of gas production and the rate of diffusion of gas molecules in the pores of the bentonite, it is possible a pressurised gas phase will accumulate in the void space of the canister (Horseman 1996; Horseman *et al.*, 1997; 1999). Gas will then enter the bentonite when the gas pressure exceeds some critical entry pressure specific to this material. Since water penetration into the canister is a prerequisite for the generation of hydrogen gas in the buffer, the timing of gas movement in the clay might coincide with that of radionuclide release into the buffer porewater. The possibility of an interaction between gas and radionuclide migration therefore emerges as an important issue in performance assessment.

While significant improvements in our understanding of the mechanisms governing gas migration in buffer bentonite have taken place, laboratory experiments (Horseman *et al.*, 2004) have highlighted a number of significant uncertainties, notably the sensitivity of the gas migration process to experimental boundary conditions and possible scale-dependency of the measured responses. These issues were best addressed by undertaking a large scale gas injection test or "Lasgit" (Sellin & Harrington, 2005).

Lasgit is a full-scale demonstration experiment operated by Svensk Kärnbränslehantering AB (SKB) at the Äspö Hard Rock Laboratory (HRL) at a depth of 420m (see Figure 2-1). The installation phase of Lasgit was undertaken from 2003 to early 2005 and consisted of the design, construction and emplacement of the infrastructure necessary to perform the experiment (Cuss *et al.*, 2010). Artificial hydration of the buffer was initiated on the 1st February 2005 following the closure of the deposition hole. Therefore Lasgit had been in continuous operation for 1,460 days (4 years) prior to the start of the FORGE project.

1.2 OBJECTIVES

The aim of Lasgit was to perform a series of gas injection tests in a full-scale KBS-3 deposition hole. The objective of the experimental programme was to provide quantitative data to improve process understanding and test/validate modelling approaches which might be used in performance assessment. Specific objectives were:

- (1) perform and interpret a large-scale gas injection test based on the KBS-3 repository design concept,
- (2) examine issues relating to up-scaling and its effect on gas movement and buffer performance,
- (3) provide additional information on the process of gas migration, and
- (4) provide high-quality test data to test/validate modelling approaches.

Data from Lasgit was used by a number of numerical modelling groups for a core bench-marking exercise.

2 Experimental set-up

The Lasgit experiment was commissioned in deposition hole No. DA3147G01 - the first emplacement borehole to be drilled at the Äspö HRL. The deposition hole has a length of 8.5 m and a diameter of approximately 1.75 m. A full-scale KBS-3 canister was modified for the Lasgit experiment with thirteen circular filters of varying dimensions located on its surface in three separate arrays (see Figure 2-2), to provide point sources for gas injection feigning potential canister defects. These filters could also be used to inject water during the hydration stages to help locally saturate the buffer around each test filter. As seen in previous studies such as Febex, high water saturations (~95%) are difficult to achieve. Therefore filter mats were placed in strategic positions both within the buffer and on the rockwall to aid hydration. The canister was surrounded by specially manufactured pre-compacted bentonite blocks, all of which had initial water saturations in excess of 95% (Cuss *et al.*, 2010). As the bentonite became saturated it swelled to fill any construction gaps and formed a seal around the canister.

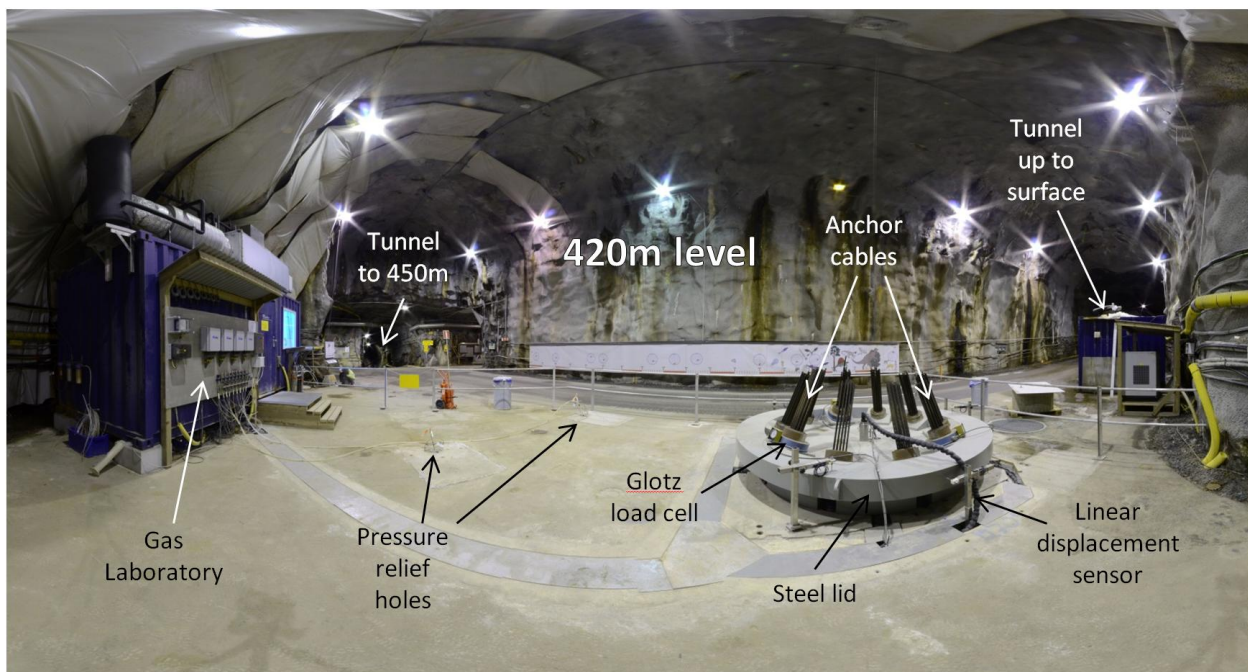

Figure 2-1 - A panoramic view of the Lasgit test site located 420m below ground at the Äspö Hard Rock Laboratory in Sweden. The photo shows the position of the deposition hole, gas laboratory, pressure relief holes (containing a series of packed intervals in order to monitor porewater pressure in the surrounding fracture network) and some of the instrumentation attached to the steel lid.

The deposition hole, buffer and canister were equipped with instrumentation to measure the total stress, pore-water pressure and relative humidity in 32, 26 and 7 positions respectively (see Figure 2-2 for the location of pore-water sensors). Additional instrumentation continually monitored variations in temperature, relative displacement of the lid & canister, and the restraining forces on the rock anchors. The emplacement hole had been capped by a conical concrete plug retained by a reinforced SS2172 carbon steel lid capable of withstanding over 5000 kN force. The experiment was monitored and controlled from a temperature controlled "Gas Laboratory" that allowed remote control and monitoring of the test to be undertaken by project staff remotely.

The boundary conditions of the experiment were those dictated by the pressures and stresses building up naturally within the buffer during re-hydration. The canister lid had been pre-stressed to 1300 kN as to impose a force comparable with that which would be generated by back-fill within a URL. The experiment was conducted at ambient temperatures.

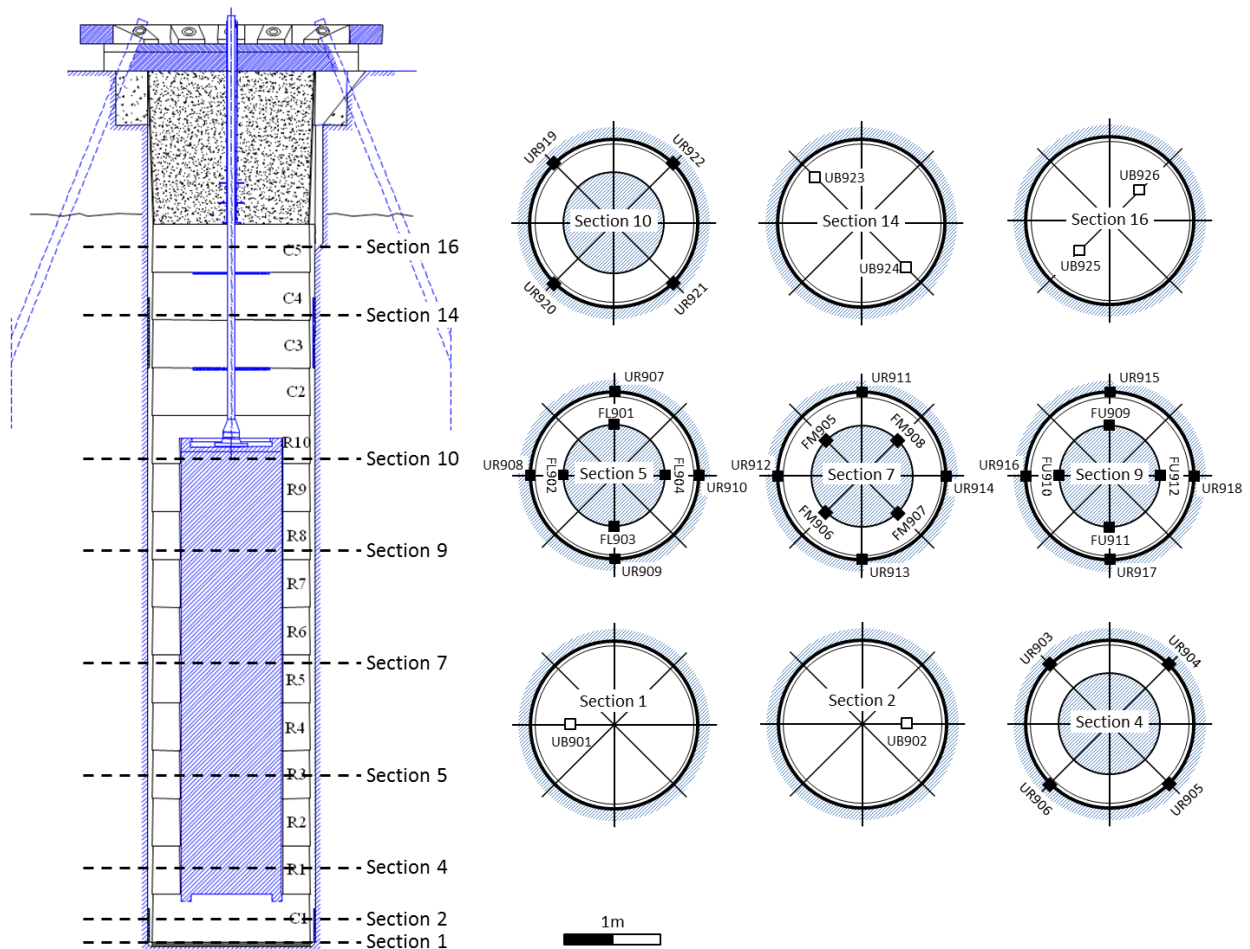

Figure 2-2 - Schematic of the layout of the Lasgit experiment showing the locations of sensors.

Lasgit is a highly instrumented experiment. Directly measured parameters included: 5 temperature sensors; pressure in 12 canister filters; pressure in 3 filter mats; stress on the canister in 3 locations (1 axial and 2 radial stress); displacement of the canister lid and canister in 7 different directions; axial stress on 3 of the rock anchors; pore pressure in 9 intervals within 2 local pressure relief holes (as well as pressure in the packers); pressure, volume and flowrate in the 4 ISCO syringe pumps; stress and temperature within the bentonite at 9 locations; pore pressure (and temperature) within the bentonite at 6 locations; pore pressure and temperature at the rock wall at 20 locations; stress (and temperature) at the rock wall at 20 locations; and relative humidity within the bentonite at 7 locations. From these parameters it is possible to calculate: hydration flow rate; water flow rate (into the system) during hydraulic testing; gas flow rate (into the system and into the clay) during gas testing; and total volume of water/gas pumped into the system. All parameters were recorded every 15 minutes through the history of the experiment during FORGE, except for relative humidity which was logged separately.

Lasgit has a lifetime greatly in excess of that of the FORGE project. It was started on 1st February 2005 and was therefore four years (1460 days) in operation by the start of FORGE. At the completion of FORGE (31st December, 2012) Lasgit will have been in continuous operation for 2,890 days (7.9 years). Table 2-1 summarises the activities undertaken during the complete test history.

Test stage	Duration
Artificial hydration of filter mats	Day 0 – end of FORGE (Day 2890; 7.9 years)
• Artificial hydration phase 1	• Day 0 – 843
• Gas test 1 in filter FL903	• Day 813 – 1110
○ Hydraulic test	○ Day 843 – 917
○ Gas injection test	○ Day 917 – 1010
○ Hydraulic test	○ Day 1010 – 1110
• Artificial hydration phase 2	• Day 1110 – 1430
• Gas test 2 in filter FL903	• Day 1430 – 2064
○ Hydraulic test	○ Day 1473 - 1577
○ Gas Injection test	○ Day 1577 - 1964
○ Hydraulic test	○ Day 1964 - 2019
• Gas test 3 in filter FU912	• Day 2019 -2072
○ Hydraulic test	○ Day 2072 Abandoned
• Gas test 3 in filter FU910	• Day 2072 - 2725
○ Hydraulic test	○ Day 2085 – 2141
○ Leak off test	○ Day 2141 – 2257
○ Gas injection test	○ Day 2257 – 2673
○ Hydraulic test	○ Day 2673 – 2726
• Gas test 4 in filter FL903	• Day 2726 – February 2014 planned
○ Hydraulic test	○ Day 2726 – 2781
○ Leak off test	○ Day 2781 – end 2012

Table 2-1 List of test stages during the complete history of Lasgit

3 Results

The deposition hole was closed on the 1st February 2005 signifying the start of the first hydration phase. Artificial hydration began a few months later on the 18th May 2005 after 106 days of testing and was suspended at Day 843 to allow the first set of preliminary measurements to be made. By the time the hydration phase had been suspended, pressures within the deposition hole and bentonite had increased substantially, with the average axial stress (monitored at separate locations throughout the clay) around 5.1 MPa, the average radial stress (measured at the rock wall) close to 4.15 MPa, the average total stress acting on the canister around 4.5 MPa, the average porewater pressure (measured at the rock wall) approximately 1.75 MPa and the average porewater pressure in the bentonite around 0.32 MPa.

While data from the psychrometer and porewater pressure sensors showed sections of the clay remained in suction/hydraulic disequilibrium, it was decided to examine the evolution of gas transport behaviour within the buffer during the hydration phase by performing a number of preliminary gas tests. The filter selected for this task was FL903 located in the lower array as data indicated this section of the clay was more mature than the overlying material. To minimise the possible impact of gas injection on the continued hydration of the clay, relatively small volumes of gas were used during each gas test.

3.1 GAS INJECTION TEST 1 (DAY 813 – 1110) [PRE-FORGE]

Gas (helium) testing began on Day 917 with the introduction of an initial gas volume of around $1.26 \times 10^{-3} \text{ m}^3$ into the test system. This was slowly compressed by pumping water into an external reservoir which gradually raised the gas pressure in FL903, Figure 3-1a. Inspection of the graph indicates that during the first gas pressurisation event (Days 917 to 930), the measured pressure began to depart from the predicted pressure derived from the ideal gas law. This occurred at around Day 924. As gas pressure continued to increase the departure in predicted versus measured gas pressure continued and was of sufficient magnitude to be indicative of gas penetration of the buffer. Analysis of the data suggests that gas flow into the buffer occurred at a pressure of about 0.65 MPa. This is much lower than the anticipated gas entry pressure for a saturated intact bentonite (Harrington & Horseman, 2003). Assuming the incomplete hydration state of the buffer and the heterogeneous nature of the stress field within the clay, it seems probable that the gas was exploiting these differences. However, when gas pressurisation was stopped at Day 930 and the pressure held constant, flow into the clay dramatically reduced by around 98.5%, indicating that propagation of the main gas pathway(s) practically cease when the pressure is held constant. The small continuous flux observed following this event may stem from the movement of gas along small-scale features which are only present because the bentonite is not fully mature. If correct, these fluxes should reduce in magnitude during later tests as the buffer equilibrates. Given the sudden reduction in flow, it suggests that gas was not flowing within the original porosity of the clay and that the initial network of gas pathways failed to locate an adequate sink capable of accommodating the small in-flow of gas.

When gas pressurisation was reinstated on Day 952, the departure between measured and predicted gas pressure continues almost immediately (Figure 3-1b), indicating that the previous network of gas pathways continued to extend as soon as the pressure began to increase. Gas flow into the clay gradually increased with time until Day 970, at which point there was a marked increase in flow. This occurred when the gas pressure was marginally greater (approximately 0.2 MPa) than the local total stress measured on the rock wall, but was marginally smaller (around 0.25 MPa) than the radial stress measured some distance away on the canister surface at PC903. Axial stress measured at PB902 was also marginally higher than the gas pressure, by around 0.3 MPa. Gas pressure continued to increase reaching a peak pressure of 5.66 MPa at Day 972.3. This was followed by a small spontaneous negative transient leading to a quasi-steady state at a

gas pressure of around 5.5 MPa. Examination of the post peak gas flux exhibits dynamic behaviour (over and undershooting flux into the system) suggestive of unstable gas flow. These observations are qualitatively similar to results reported by Horseman *et al.* (1999) and Harrington & Horseman (2003) performed on laboratory scale tests.

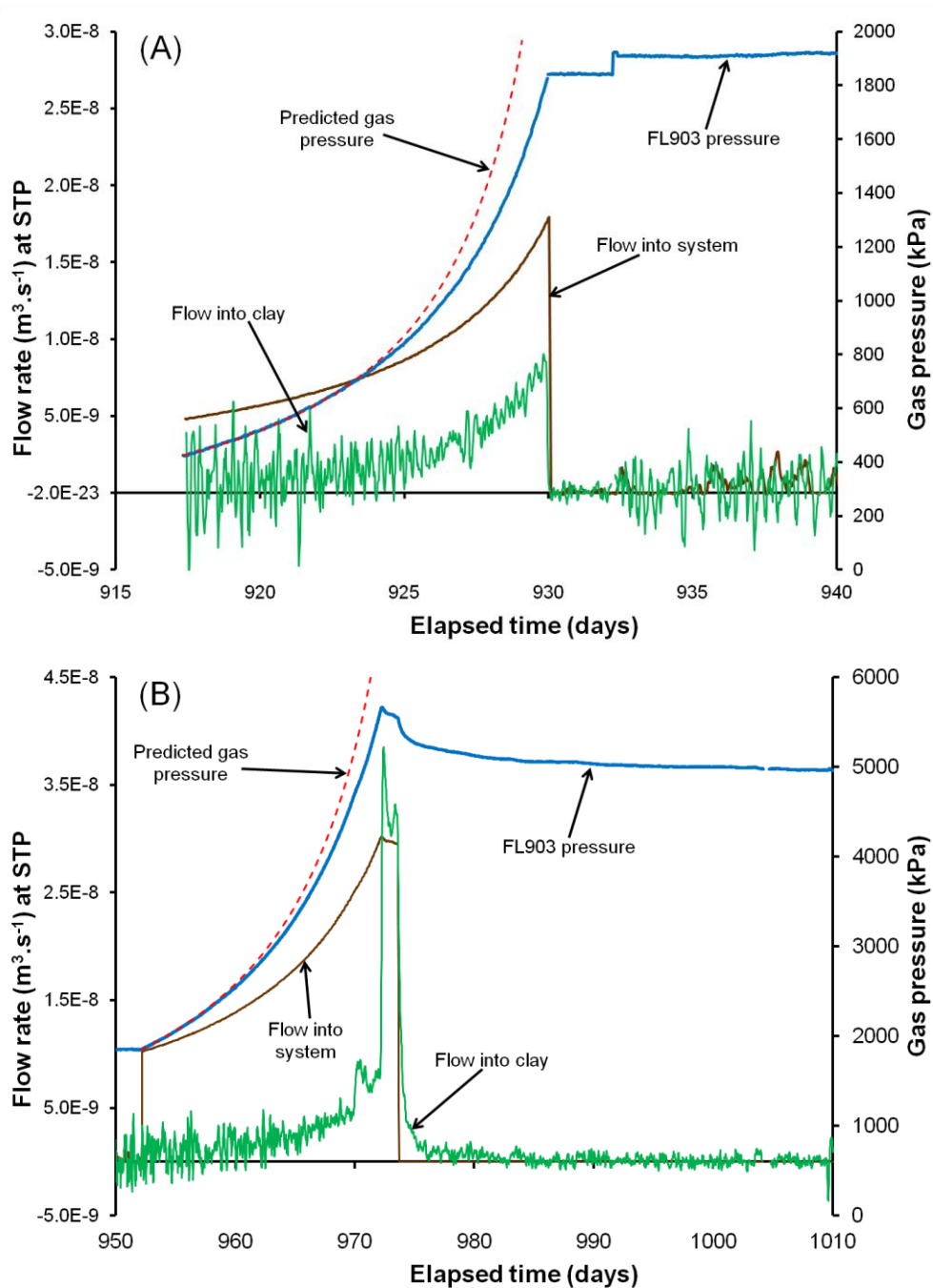

Figure 3-1 - Plots [A] and [B] show the entire injection history for Gas test 1. STP flow rates into the injection system and the clay as well as measured and predicted gas pressures are plotted against elapsed time. Flow into the clay is calculated using a combination of weighted moving average and time moving average (mean). For plot [A] the departure between measured and predicted gas pressure is symptomatic of gas penetration of the buffer. In plot [B] the peak pressure response is symptomatic of the development of 'major' gas pathways within the buffer and is qualitatively similar in response to small-scale experiments reported by Horseman *et al.* (1997, 1999, 2004).

The injection pump was stopped (i.e. a shut-in test) at Day 974 and the gas pressure allowed to decay providing an estimate for the apparent capillary threshold pressure which is tentatively

estimated to be around 4.9 MPa. This pressure is significantly higher than that required to initiate gas entry but is very similar to the average radial stress measured on the canister which was also close to the axial stress measured locally within the clay at PB902. This suggests a strong correlation between gas transport and total stress and supports the observations reported by Harrington & Horseman (2003) based on laboratory scale tests. Analysis of the pressure decay curve shows conspicuous breaks in slope indicative of the sealing and temporary formation of highly unstable gas pathways.

Following peak gas pressure a well pronounced increase in radial stress occurred around the entire base of the deposition hole, with the highest increase noted in the vertical plane below the point of injection. This strongly suggests gas preferentially moved downwards, probably along the interface between the canister and buffer. It is notable that the radial stress immediately adjacent to FL903 actually decreased during this time. Analysis of the porewater pressure sensors located within the buffer shows no obvious sensitivity to the injection of gas. In contrast, axial stress sensors located beneath and above the canister appear to register the passage of gas. A small inflection in the rate of increase in axial stress at the base of the canister occurred shortly after the peak in gas pressure. Such a reduction in stress can only be caused by the removal of load, suggesting some form of displacement had occurred as a result of gas injection.

3.2 GAS INJECTION TEST 2 (DAY 1430 – 2064)

Following one year of artificial hydration of all filters and filter mats a repeat test was conducted in filter FL903. One question arising from Gas test 1 was whether the gas “escaped” the deposition hole. In order to address this in Gas test 2, neon was selected as the test permeant, to facilitate tracking of the gas through the host rock by future gas sampling of the packed intervals in each of the pressure relief holes (neon is absent from the natural pore waters of Äspö).

Gas testing began on Day 1606 in filter FL903 from a starting pressure of 1.3 MPa. This was higher than the starting pressure in Gas test 1 as pore pressure at this location had increased with continuing artificial hydration. Gas test 2 was planned to give more detail than Gas test 1, with four pressure ramps (instead of 2) and prolonged gas injection following gas breakthrough.

The first pressure ramp raised gas pressure from 1.3 to 2.55 MPa over a 9 day period, at which point the gas pressure was held constant for a further 15 days while flux into the clay was monitored with time (Figure 3-2a). Analysis of the data indicated a small flux into the clay began at the onset of pumping, suggesting that the gas entry pressure was close to the start value of 1.3 MPa. This is significantly higher than for Gas test 1 (0.65 MPa) and is further evidence for the maturation of the clay. Once the injection pump was switched to constant pressure mode and the pressure in the filter held constant at 2.55 MPa, gas flow into the clay dramatically reduced and continued to decline over the next 15 days, resulting in a small background flux of around $2.5 \times 10^{-10} \text{ m}^3 \cdot \text{s}^{-1}$. This was around 95% lower than that observed prior to the change in pump mode. The similarity in response to that from the earlier gas test suggests that the same processes governing the precursor movement of gas remain in operation.

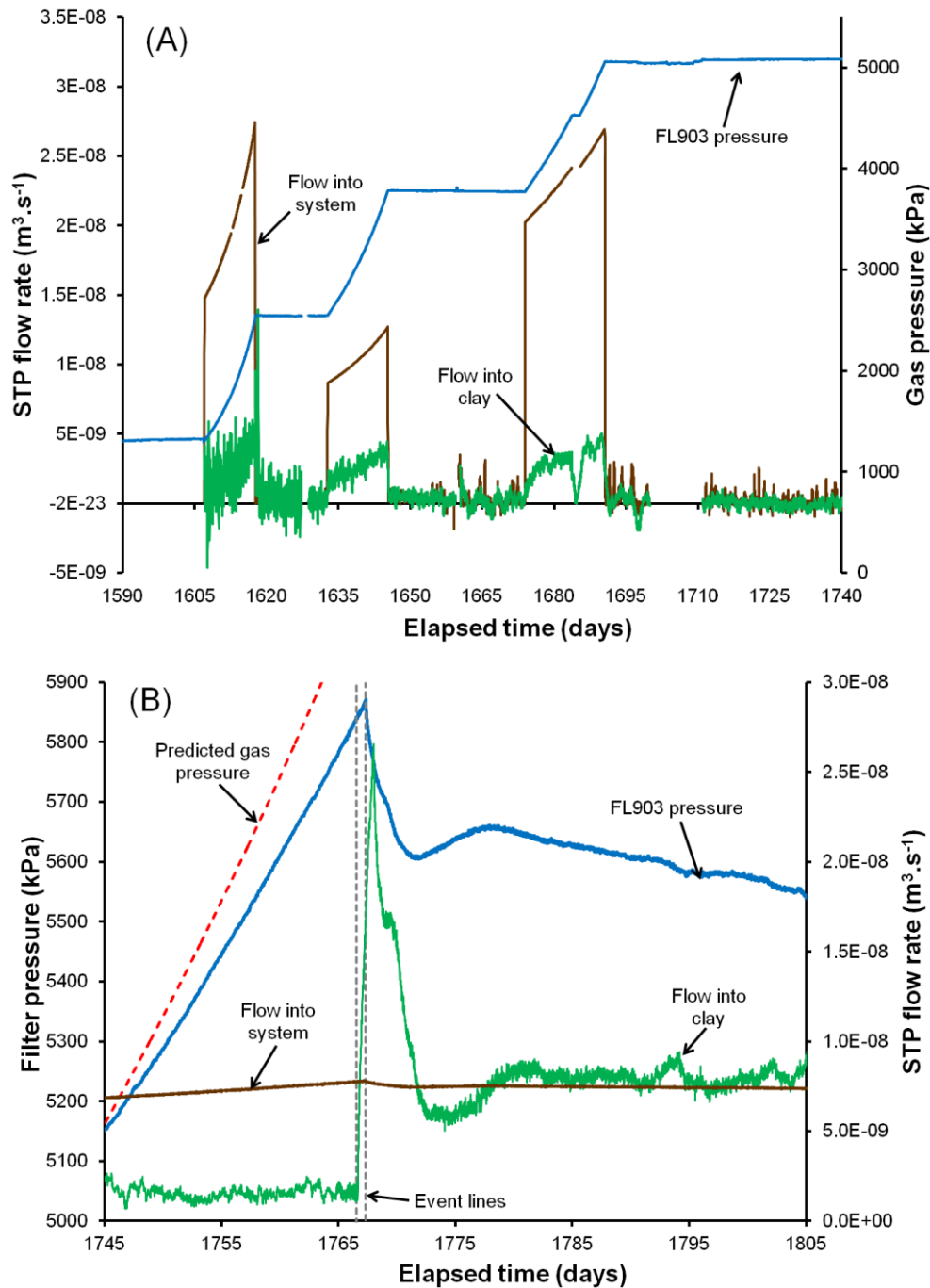

Figure 3-2 - Plots [A] and [B] show the entire injection history for Gas test 2. STP flow rates into the injection system and the clay as well as measured and predicted gas pressures are plotted against elapsed time. Inspection of plot [A] shows the reduction in flux into the clay during each constant pressure step. Plot [B] shows the ‘major’ gas entry event signified by the rapid increase in flux into the clay. This is followed by a well-defined negative flux transient which first under- and then overshoots the injection flow rate into the system. This is symptomatic of unstable gas pathways.

A second ramp raised pressure to 3.8 MPa over 9 days, followed by a period of constant pressure for 28.6 days. A third ramp raised pressure to a final target of 5.05 MPa over 16 days and pressure was held constant for a total of 52 days (from Day 1690 to 1742). As with previous observations, the switch from pressure ramp to constant pressure resulted in a reduction of flux in excess of 95%. It can be noted that the flux observed during the successive constant pressure steps reduced. The lack of correlation between the rate of gas flow into the clay and the gas pressure gradient driving the flux cannot be reconciled with classic concepts of two-phase flow

(Aziz & Settari, 1979; de Marsily, 1986). In summary, a flux of 2.5×10^{-10} , 7.2×10^{-11} , and 1×10^{-12} was seen at constant pressure stages of 2.55, 3.8 and 5.05 MPa respectively. The large reduction in gas flow (ranging from 95-98.5%) when pressure was held constant suggests an apparent reduction in gas permeability of the buffer. While this does not conform to classic concepts of two-phase flow it can be explained by a pathway propagation model. According to Griffith crack theory, a crack will only propagate when the decrease in strain energy just balances the increase in surface energy. In essence, this can be viewed as the slow time-dependent expansion of gas pathway(s), conceptually little different to that of inflating one or more tiny balloons within the bentonite, where the walls of the latter represent the pathway surfaces within the clay. As gas pressure increases the cracks/balloons slowly expand/propagate resulting in a larger network of gas-filled pathways. If gas pressure is held constant, the capacity for further expansion of the cracks/balloons is limited, by both the balance in strain and surface energies and by the availability of inherent weaknesses within the buffer system. The observed reduction in gas inflow rates for the higher constant pressure steps strongly support this line of reasoning and suggest that the availability or interconnectivity of such weaknesses within the clay (from small-scale transient features related to hydraulic/stress disequilibrium) is limited locally around the point of the injection zone. Given the reduction in gas flow rates at higher pressures, it seems clear from the data that only a limited quantity of gas can be injected into the clay through this mechanism, suggesting that as the buffer hydrates, the capacity for this type of flow will reduce.

During the third constant pressure stage the gas within the injection system was refilled in order to facilitate prolonged injection post gas breakthrough. The final gas injection stage was initiated on Day 1742 with a relatively slow injection rate, Figure 3-2b. At Day 1766.55 gas flow into the buffer spontaneously increased, exhibiting a well-defined peak before decreasing to a steady-state value of around $8 \times 10^{-9} \text{ m}^3 \cdot \text{s}^{-1}$. Gas pressure continued to increase reaching a maximum value of 5.87 MPa at Day 1767.3, 0.21 MPa higher than for the Gas test 1. Peak pressure was followed by a spontaneous negative pressure transient which approaches an asymptote of around 5.55 MPa. Figure 3-2b shows the response of the buffer to the ingress of gas during this phase of testing is very similar in form to that observed in the small-scale laboratory experiments reported by Harrington & Horseman (1999, 2003). Post peak, both flux and pressure data initially “under-shoot” then “over-shoot” the ultimate asymptote value symptomatic of unstable gas pathways (Harrington & Horseman, 1999).

At peak gas pressure total stress and porewater pressure sensors indicate gas flow is both localised and a highly complex dynamic process with pathways opening and closing probably in response to localised changes in gas pressure (Figure 3-3). Analysis of the data indicates conspicuous kicks in value at and after peak gas pressure, providing strong evidence for the time-dependent evolution of a tortuous network of unstable gas pathways. While this data indicates that gas pathways initially propagate downwards and then across and upwards through the clay or clay/rock wall interface, later ‘breakthrough’ events from different sensor locations indicate that the gas pathway network continues to evolve, even though the system is at quasi steady-state.

The pressure recorded in filter FL901 increased 6.5 days after gas peak pressure was recorded in injection filter FL903, as seen in Figure 3-4. A second increase in pressure occurred in FL901 10 days later. Filter FL901 was 180° around the canister, with filters FL902 and FL904 90° around the canister. It can be seen that gas propagated to the opposite side of the canister without intercepting either of the filters (FL902/904) between FL903 and FL901. This suggests that the gas pathway was a highly localise, tortuous pathway and that the entire canister/buffer interface was not conductive. It could also suggest that the gas propagated through the buffer and not along the interface.

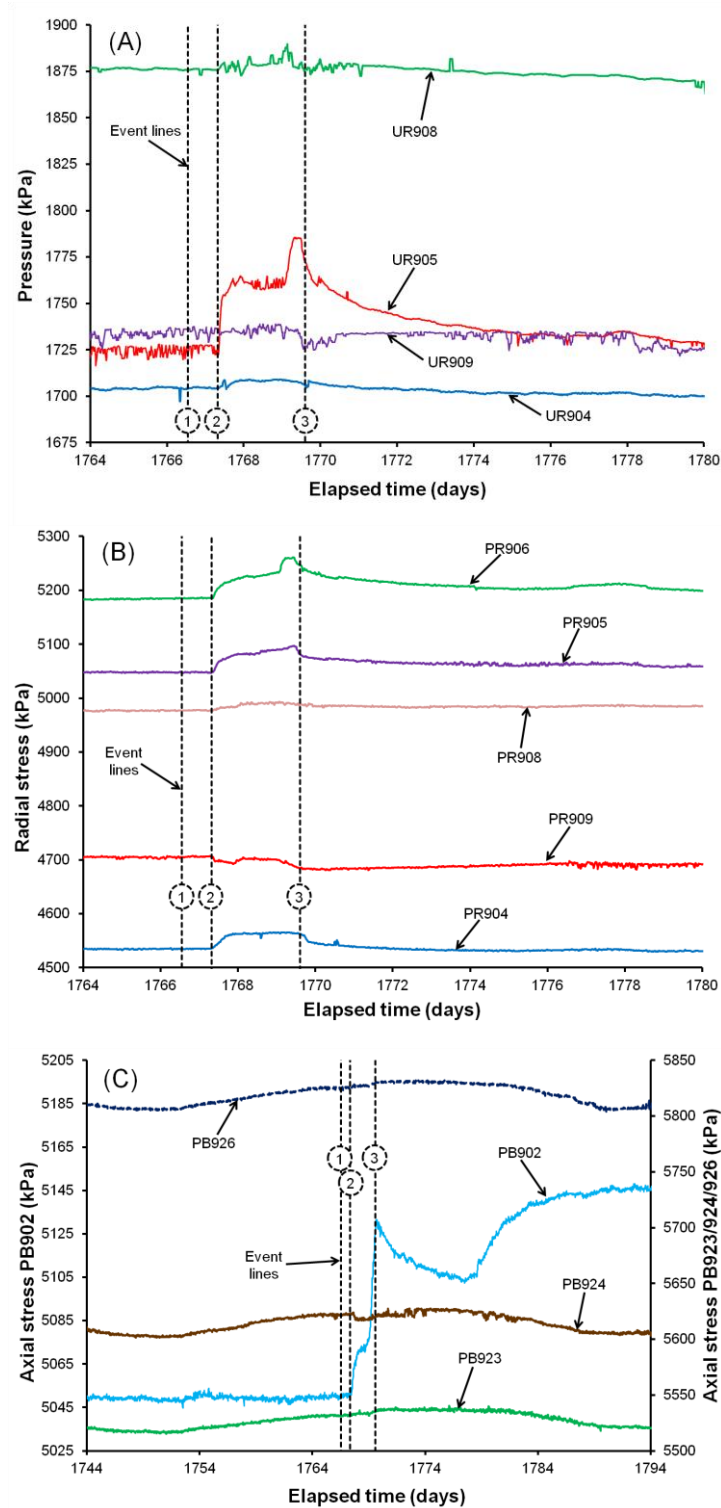

Figure 3-3 - Data from deposition hole instrumentation before and after major gas entry at Day 1766.55; [A] shows a well-defined response from porewater pressure sensor UR905. The absence of a kick in neighbouring sensors suggests localised pathway flow; [B] shows a clear link between changes in radial stress and peak gas pressure. The strength of these responses is related to the geometry and spatial distribution of pathways within the buffer; [C] shows the output for a number of axial stress sensors. The output from sensor PB902 shows a series of breakthrough events where total stress spontaneously increases/decreases with time. This provides strong evidence for a highly complex gas pathway network which evolves temporally and geospatially. Event (1) is the start of the major gas flow event, (2) is the peak in gas pressure, and (3) is the peak seen in PB902.

Gas reached pressure sensor UB902, which is located towards the bottom of the deposition hole within bentonite block C1. In Gas test 1 it had been proposed that the gas moved down the canister/buffer interface and then between bentonite blocks R1 and R2 exploiting weaknesses associated with interfaces. The propagation of gas to UB902, in part, demonstrates that gas has propagated through the bentonite buffer as it is improbable that gas could have reached the outer wall of the deposition hole and then propagated to UB902.

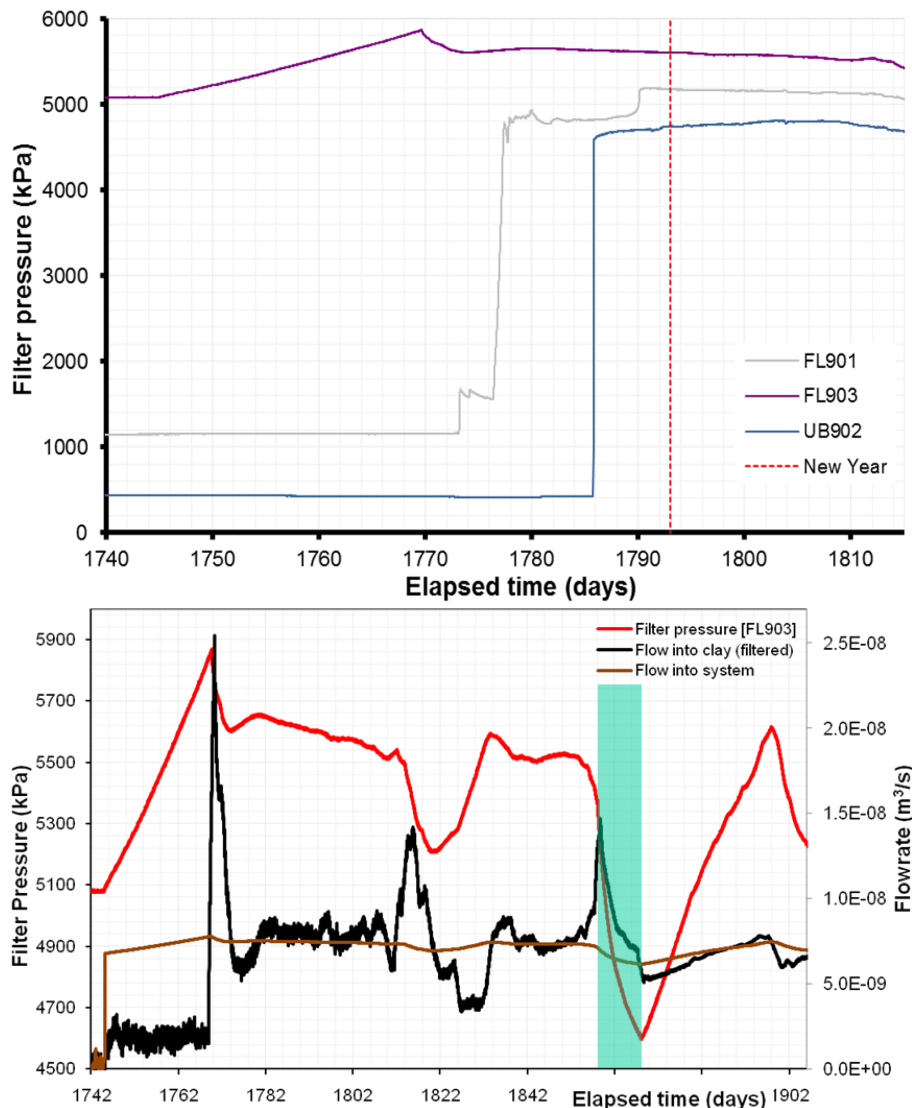

Figure 3-4 - Data showing prolonged gas injection in FL903. Left) as gas injection continued it resulted in an increase in pressure at FL901; pressure in sensor UB902 sometime later. This shows that gas propagated to these locations. Right) Pressure and flow during prolonged gas injection.

One objective of Gas test 2 was to continue gas injection after peak pressure had been achieved for a prolonged period. As shown in Figure 3-4, the final gas injection step was started on Day 1745, gas breakthrough occurred on Day 1767, and gas injection was stopped on Day 1910. Therefore the fourth gas injection stage was 165 days long, with gas injected for 142 days following gas breakthrough. In general, the familiar “over-“ and “under-shooting” of flow into the clay about the flow into the system (Figure 3-4) was observed. Following initial gas breakthrough flow into the clay was similar to flow into the system with minor fluctuations after about 17 days and during this period gas pressure slowly decayed. At approximately Day 1813.4 flow into the clay increased and the injection pressure decayed by 300 kPa; at this time no corresponding change in stress can be identified. At a pressure of about 5.2 MPa gas pressure began to recover and peaked for a second time at Day 1833 as the flow into the clay can be seen to increase. Between Day 1839 and Day 1852.5 pressure remained constant and flow into the

clay matched the flow into the system (i.e. all gas entering the system was entering the clay). At this time it appears that the system has reached quasi-static equilibrium. However, on Day 1853 pressure can be seen to start reducing as flow into the clay increased. The drop in pressure over the following 10 days saw a reduction in injection pressure of nearly 1 MPa. On Day 1868 the injection pump required re-filling, which is a standard procedure. Following this, gas pressure started to increase once pumping had been re-initiated. As this behaviour was instantaneous, it has been deduced that one of the air-actuated valves on the control board had partially been opened and that the pump had therefore been slowly leaking between Day 1860 and 1868. This was not immediately remediated as the behaviour was similar to that seen at Day 1813.

As pressure had “leaked” from the pumping system it was decided to continue injection of the remaining volume of neon and to observe behaviour once gas breakthrough had been re-established. Over a period of nearly 30 days gas pressure recovered and peaked at Day 1897.9 at 5,616 kPa. A distinct peak is observed with pressure decaying for the remaining 10 days of the period; however, no peak in flow into the clay is observed. This suggests that 5.6 MPa was sufficient to re-establish existing pathways that continued to propagate. From approximately Day 1860 onwards the pressure in filter FL901 can be seen to decay, suggesting that the drop in gas pressure at this time was sufficient to “isolate” this sink and that the increase in gas pressure did not re-establish flow to this location.

Gas sampling in the pressure relief holes after the completion of the gas-injection phase clearly showed a trace of neon of 117 ppm in interval PRH1-2. All other PRH intervals showed undetectable (<50ppm) amounts of neon both before and after Gas test 2.

Figure 3-5 shows a summary of the gas migration direction inferred from Gas test 1 and 2. As can be seen, in Gas test 1 the gas propagated along the outside of the canister downwards. It is probable that gas exited the deposition hole along the interface between blocks R1 and R2. In Gas test 2 it is clear that the same gas pathway was not exploited. Gas propagated 180° around the canister to filter FL901 and from here gas propagated downwards towards the bottom of the deposition hole.

3.3 GAS INJECTION TEST 3 (DAY 2257 – 2614)

In 2012 gas testing switched from the previously tested filter (FL903) to an upper array filter. Filter FU910 was selected; this filter is smaller in diameter (25 mm, compared to 50 mm for FL903). This meant that Gas test 3 would investigate neon movement under different stress conditions higher in the deposition hole and for a different hydration state, dictated by the size of the injection filter and total duration of artificial hydration.

Gas testing began on Day 2257 in filter FU910 from a starting pressure of 1 MPa, with four pressure ramps similar to Gas test 2 planned with the final stage conducted for a prolonged period of time. The first pressure ramp raised gas pressure to 2.25 MPa over a 17 day period, at which point the gas pressure was held constant for a further 31 days while flux into the clay was monitored with time (Figure 3-6a). Analysis of the data indicated a small flux into the clay began at the onset of pumping, suggesting that the gas entry pressure was close to the start value of 1.0 MPa. Once the injection pump was switched to constant pressure mode and the pressure in the filter held constant at 2.25 MPa, gas flow into the clay dramatically reduced and remained low, resulting in a small background flux of around $2 \times 10^{-11} \text{ m}^3 \cdot \text{s}^{-1}$; this equates to a reduction in flow in excess of 99%.

A second ramp raised pressure to 3.5 MPa over 17 days, followed by a period of constant pressure for 36 days. A third ramp raised pressure to a final target of 4.75 MPa over 16 days and pressure was held constant for a total of 100 days (from Day 2377 to 2477). As with previous observations, the switch from pressure ramp to constant pressure resulted in a reduction of flux in excess of 98%. Contrary to Gas test 2, the flux observed during the successive constant pressure steps increased. In summary, a flux of 2.1×10^{-11} , 1.1×10^{-10} , and 1.7×10^{-10} was seen

at constant pressure stages of 2.25, 3.5 and 4.75 MPa respectively. The large reduction in gas flow (ranging from 98.6 to 99.9%) when pressure was held constant suggests an apparent reduction in gas permeability of the buffer. As previously stated, while this does not conform to classic concepts of two-phase flow it can be explained by a pathway propagation model.

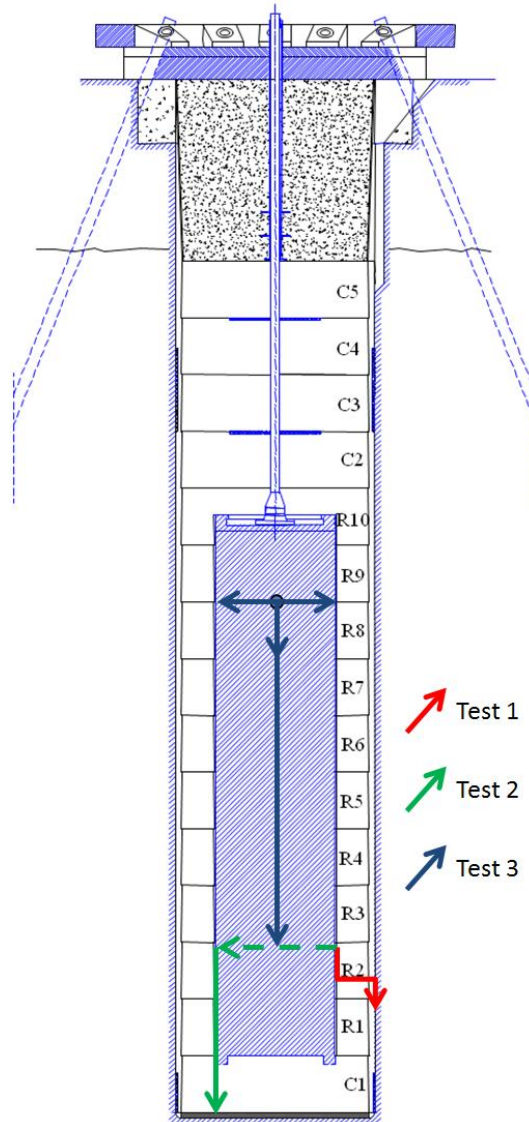

Figure 3-5 – Gas migration direction for the three gas injection tests.

The final gas injection stage was initiated on Day 2477.25 with a relatively slow injection rate, Figure 3-6b. At Day 2490.36 gas flow into the buffer spontaneously increased, exhibiting a well-defined peak of 5,190 kPa and a pressure drop. Figure 3-7b shows the pressure response in more detail, which as can be seen, was dissimilar to that seen in Gas tests 1 and 2. Initially gas pressure reduced by approximately 50 kPa to 5,147 kPa and then over the following 12 days recovered to a secondary peak of 5,300 kPa at Day 2502.3. The secondary peak had not been seen previously and had a magnitude over 100 kPa greater than the initial gas breakthrough. Pressure slowly progressed to a steady state of approximately 5,240 kPa and around $1 \times 10^{-8} \text{ m}^3 \cdot \text{s}^{-1}$ by Day 2524. By this time, flux and pressure data initially “under-shoot” then “over-shoot” the ultimate asymptote value symptomatic of unstable gas pathways (Harrington & Horseman, 1999).

On Day 2533 the logging computer failed, this resulted in the gas laboratory being isolated from the Lasgit experiment. The computer was re-instated on Day 2542, but in the intervening 9 days the gas pressure had reduced approximately 100 kPa to 2,435 kPa.

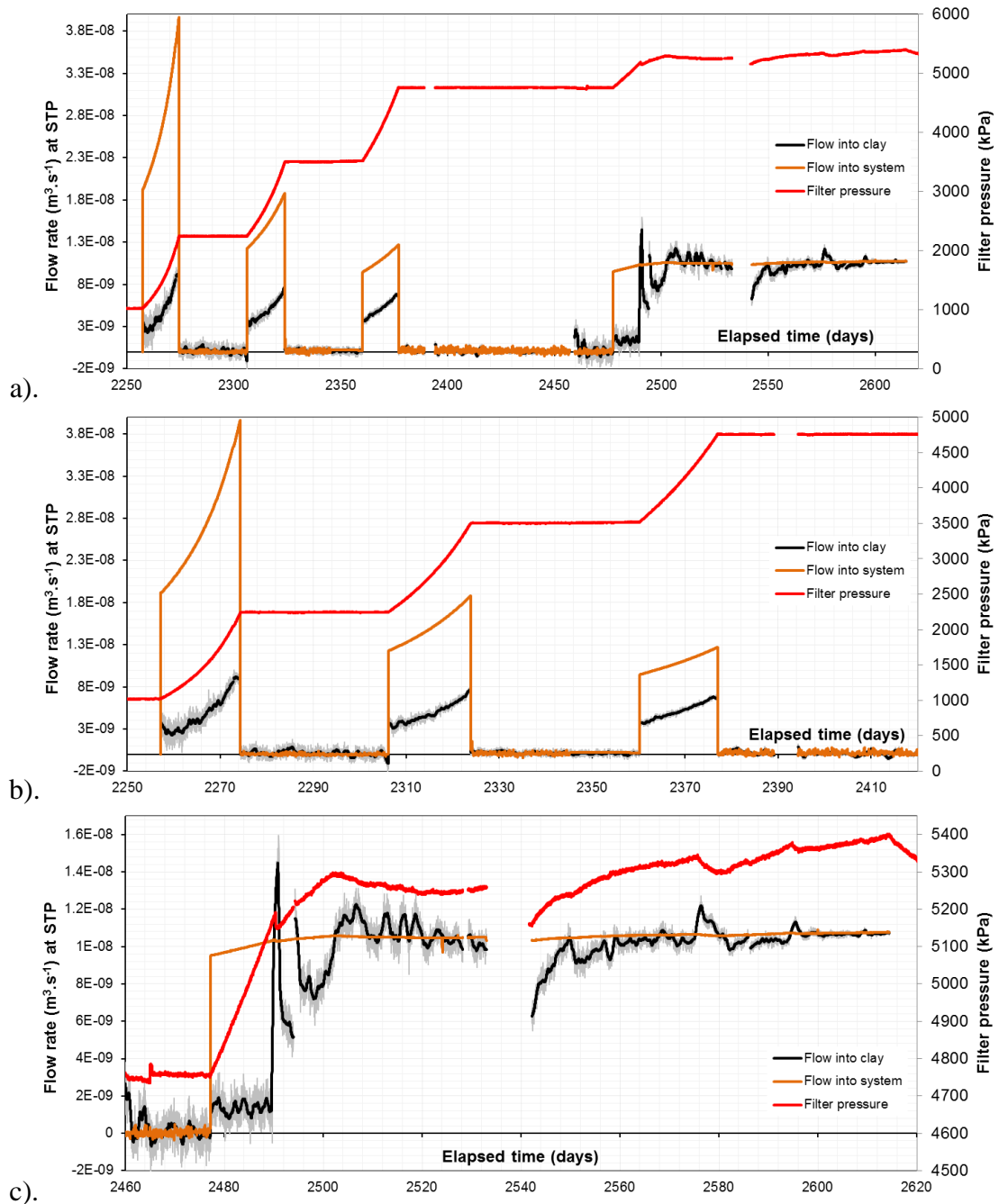

Figure 3-6 – Plot [A] shows the entire injection history for Gas test 3. STP flow rates into the injection system and the clay as well as measured gas pressures are plotted against elapsed time. Inspection of plot [B] shows the reduction in flux into the clay during each constant pressure step. Plot [C] shows the ‘major’ gas entry event signified by the rapid increase in flux into the clay. This is followed by a secondary gas peak and an eventual transient which first under- and then over-shoots the injection flow rate into the system. This is symptomatic of unstable gas pathways.

At the time of initial gas breakthrough, radial stress sensor PR915 showed a 50 kPa increase, with smaller increases being noted in PR917 (20 kPa), and PR916/918 (10 kPa), as seen in Figure 3-7c. Radial stress sensors PR915 and PR916 are closest spatially to injection filter FU910 and are both positioned 45° around the deposition hole on Section 9. Little to no stress change is seen on Section 7 of the deposition hole suggesting that initially gas did not propagate downwards. Changes in porewater pressure are noted in some UR sensors.

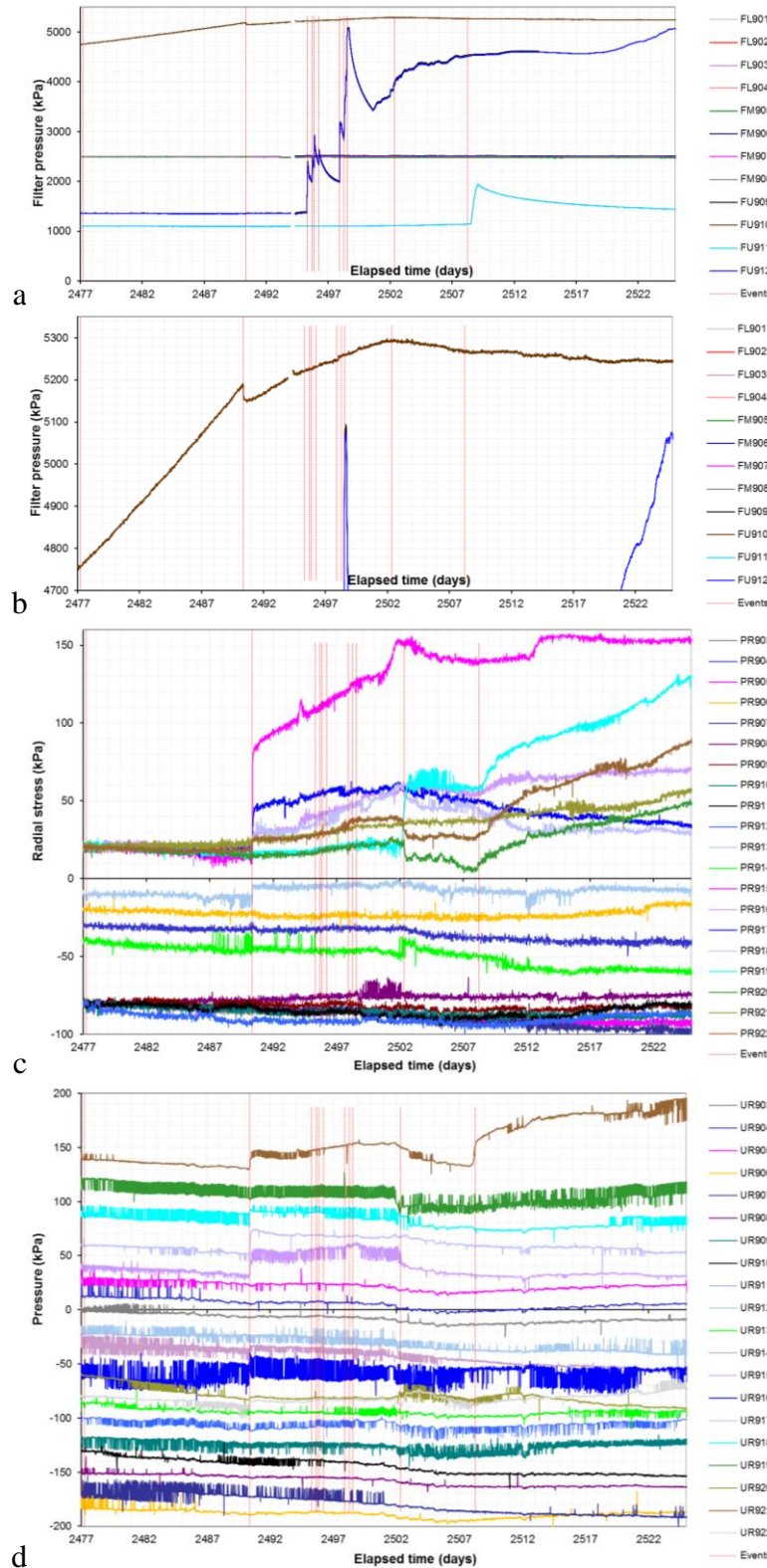

Figure 3-7 – Response of radial stress and porewater pressure on the deposition hole wall at the time of gas breakthrough. Plots [A] and [B] show pressure response of injection filter (FU910) and all other canister filters. As can be seen, the form of the pressure response at breakthrough is dissimilar to that seen during Gas tests 1 and 2 (compare with Figure 3-1 and Figure 3-2). Plot [C] shows that several of the radial stress sensors show a change at both/either the time of initial breakthrough and secondary gas peak (Note: Radial stresses have been adjusted for display purposes and are not absolute). Plot [D] shows power pressure sensor at the time of gas propagation.

Radial stress continued to rise in all four sensors located on Section 9 and peaked at the same time as the secondary gas peak. At this time, PR919 increased by 50 kPa, whilst PR920 and PR922 reduced by 15 kPa. This suggests that gas began to move upwards in the deposition hole. As seen in Figure 3-7a, a series of pressure increases were noted in filter FU912 starting from Day 2495.28; 7 pressure increase events are highlighted. None of these pressure increases correspond with a significant change in radial stress. On Day 2508.25 pressure increased in filter FU911; this event does correspond with a stress and porewater pressure change in several sensors.

Gas injection re-started on Day 2541 and pressure soon recovered. The classic under- and over-shooting of pressure and flow was seen for the remainder of the stage (Figure 3-6c). Figure 3-8 shows the pressure response of several sensors within Lasgit. As previously described, following gas breakthrough on Day 2490.36, pressure increased in filter FU909 starting on Day 2495.28. Over a period of approximately 5 weeks the pressure in FU909 increased to become similar in magnitude to injection filter FU910. Filter FU911 was next to change, with an increase of 0.75 MPa on Day 2508.25; no further pressure increase occurred for the following 7 weeks, until a second increase of approximately 0.5 MPa occurred, followed by a significant rise of 4.5 MPa on Day 2568.43. Over a 13 day period pressure in filter FU911 decayed by approximately 1.5 MPa, until on Day 2580.59 filter pressure increased to approximate that of the injection pressure.

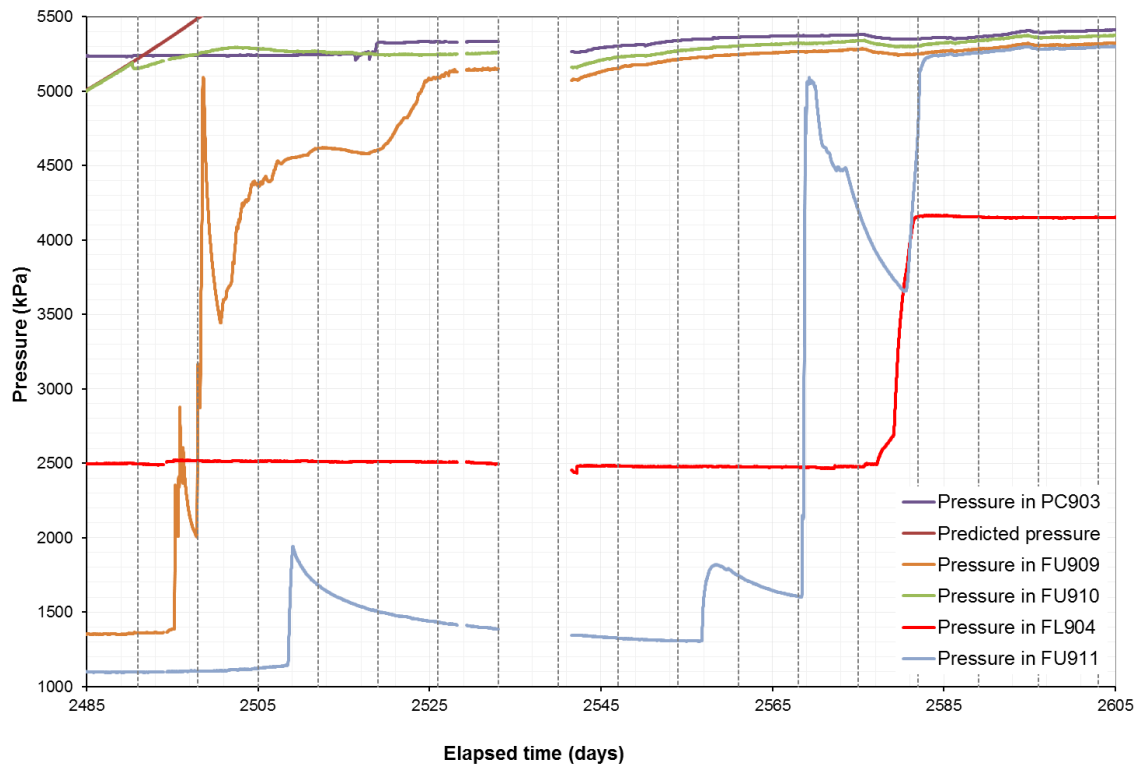

Figure 3-8 – Response of selected sensors during prolonged gas injection. In order of first change, gas reached sensors FU909, FU911, PC903 and FL904. The evolution of pressure shows that several gas pathways must have formed and that these continued to evolve spatially and temporally.

The third sensor to react was stress on the canister (PC903). Initially 2 pressure drops occurred on Day 2516.33 and 2517.95, followed by a stress rise on Day 2518.6. From this time onwards the response of PC903 mirrors FU910 and therefore it is deduced that gas propagated to this location on the canister face. The final sensor to change was filter FL904 at Day 2577.16. The lower array of filters was being used to artificially hydrate the system and the injection pump started to “back-off” as pressure in FL904 increased. The lower array of filters was isolated from the hydration circuit on Day 2579.14 and immediately the pressure in FL904 started to rise,

eventually reaching 4.8 MPa. Once the lower array was isolated, filters FL902 and FL903 started to decay, whereas filter FL901 remained almost constant for the remainder of the injection test.

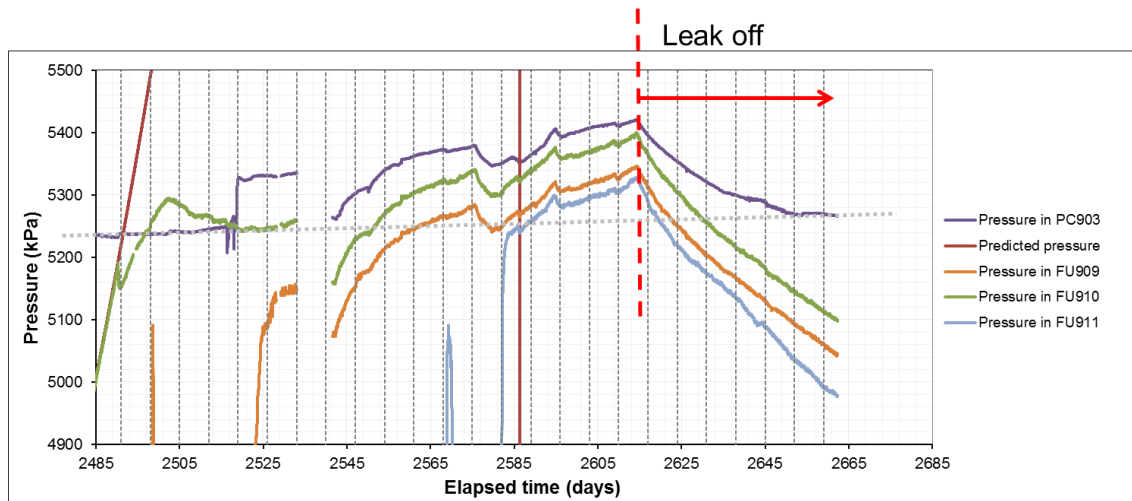

Figure 3-9 – Response of selected sensors in detail during prolonged gas injection and for the leak-off test. The Once sensors were “pressurised” they mirror the pressure in the injection filter, suggesting that the system was behaving as a single volume of gas.

It has been shown that it took considerable time for gas to reach a number of sinks and to fully pressurise these locations. As shown in Figure 3-9 the behaviour of “pressurised” sensors mirrored the injection pressure and this suggests that the system was behaving as if it was one large volume of gas. Also shown in Figure 3-9 a leak-off test was conducted at the end of the gas injection starting from Day 2614.44. The three “pressurised” sensors can be seen to reduce a similar way to the gas injection filter (FU910). However, once PC903 reaches a certain value there is no more decay; therefore the sensor is once again recording local stress at this locality.

3.4 STRESS AND GAS PEAK PRESSURE

Figure 3-10a shows the local stress conditions to filter FL903 during the two gas injection tests. Average stress is shown for radial stress [PR] and pore water pressure [UR] from the same level as the injection filter. Radial stress on the canister [PC] is also shown for section 6 of the deposition hole. As can be seen, both gas breakthrough pressures are higher than the radial stresses observed. However, a close comparison was seen with gas breakthrough and PR910. As shown in Figure 3-10b for Gas test 3, the initial gas peak occurred once injection pressure was similar to the stress recorded nearby on the surface of the canister (PC903). This magnitude was much greater than the average radial stress at the Section 9 level.

All three gas tests have shown a link between local stress and gas break-through pressure, which is confirmed in Figure 3-10c where the dotted line represents the condition when applied gas pressure is equal to local stress. As seen, the gas breakthrough pressures plot close to this condition. Comparing Lasgit data with laboratory data from tests Mx80-10, Mx80-13 and Mx80-14 (Figure 3-10d) clearly shows that gas movement is strongly controlled by the local stress state. However, predicting the magnitude of the break-through pressure appears difficult given the anisotropy seen in stress within Lasgit and the proximity of stress sensors to the injection filters.

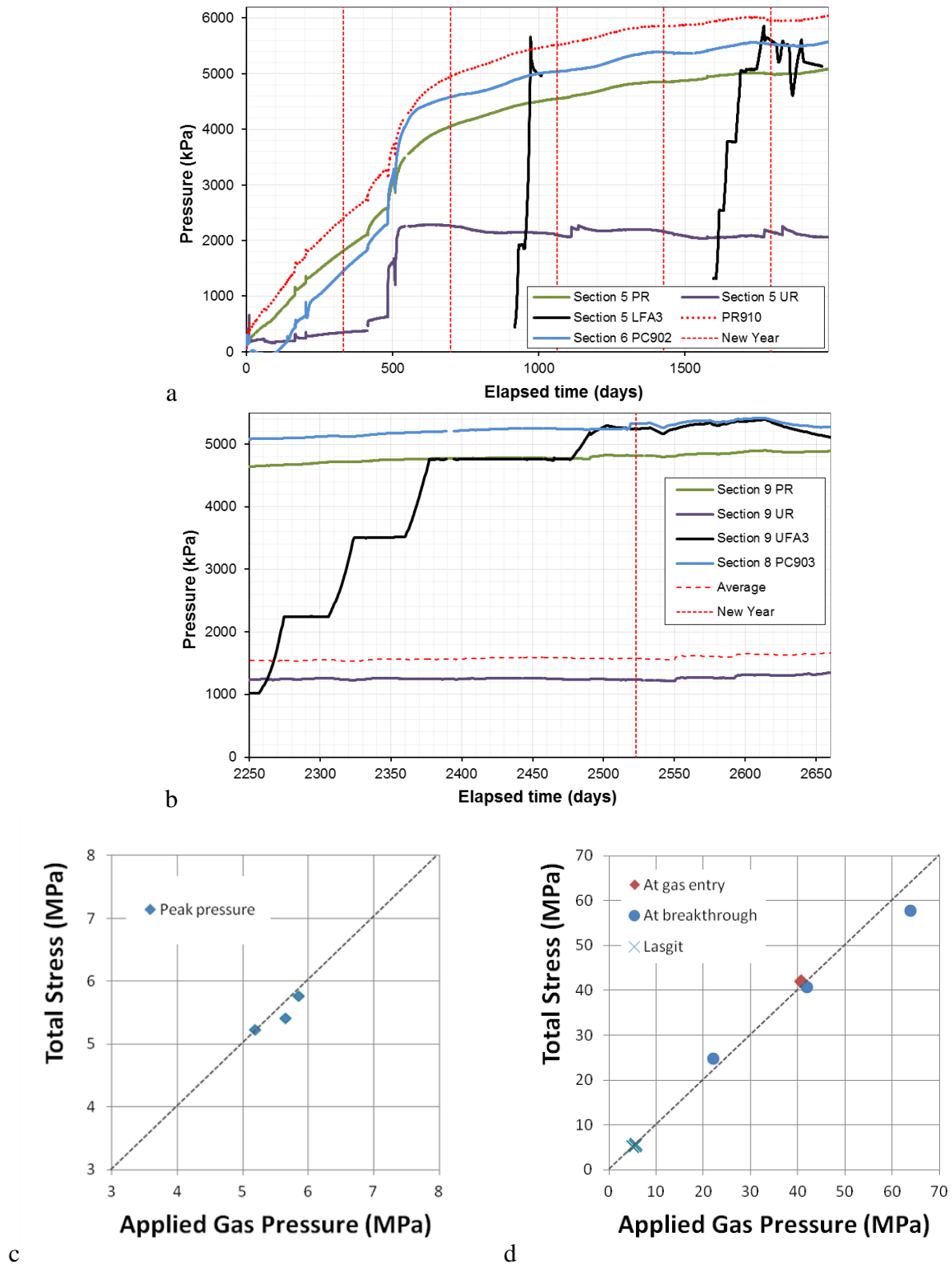

Figure 3-10 – Gas breakthrough and local stress. Plot [A] shows the results from Gas test 1 and 2, where both tests had gas breakthrough at a pressure greater than the average radial stress on the corresponding level. However, a close relationship is seen between gas breakthrough and radial stress on the deposition hole wall at PR910. Plot [B] shows breakthrough in Gas test 3 occurred at a pressure close to PC903. Plot [C] shows the close relationship between local stress and gas breakthrough pressure; which is further strengthened when Lasgit data is compared with laboratory data [D].

4 Hydration of the bentonite buffer over a seven year period

Whilst the primary aim of Lasgit is to perform gas injection tests to determine the fate of gas in the KBS-3v setup, it also offers insight into the long-term maturation of the buffer. In this section we summarise a number of features seen related to buffer hydration.

Throughout the complete history of Lasgit (Day 1 – 2,800+) a number of canister filters and all filter mats have acted as sites of artificial hydration of the buffer. Artificial hydration began on the 18th May 2005 after 106 days of testing. Up until the first gas injection test (Day 843), the pressures in all of the canister filters and hydration mats were used to hydrate the clay. Initial attempts to raise porewater pressure in the artificial hydration arrays occasionally resulted in the formation of preferential pathways, even at relatively modest excess water pressures, resulting in localized increases in porewater pressure and total stress. These pressure dependent features were not focused in one location within the bentonite but occurred at multiple sites at different times in the test history. These pathways were relatively short lived, closing when water pressure was reduced. Packers were installed into the pressure relief holes on Day 414 and sections in them closed over the period to Day 519. These operations caused clear effects throughout the deposition hole, however there was no repeat of the formation of piping through discrete channels so, on Day 656, pressures to the artificial hydration filters on the canister were increased to 2,350 kPa. From this time onwards, the injection system (filters and filter mats) was used to aid artificial hydration of the system. However, during gas testing stages (Gas test 1, Day 843 to 1110; Gas test 2, Day 1385 to 2019; and Gas test 3, Day 2019 to 2890+) some of the injection filters were isolated or used as sites of gas injection (e.g. filter FL903). However, the Lasgit system has undergone over 7 years of continuous natural and artificial hydration.

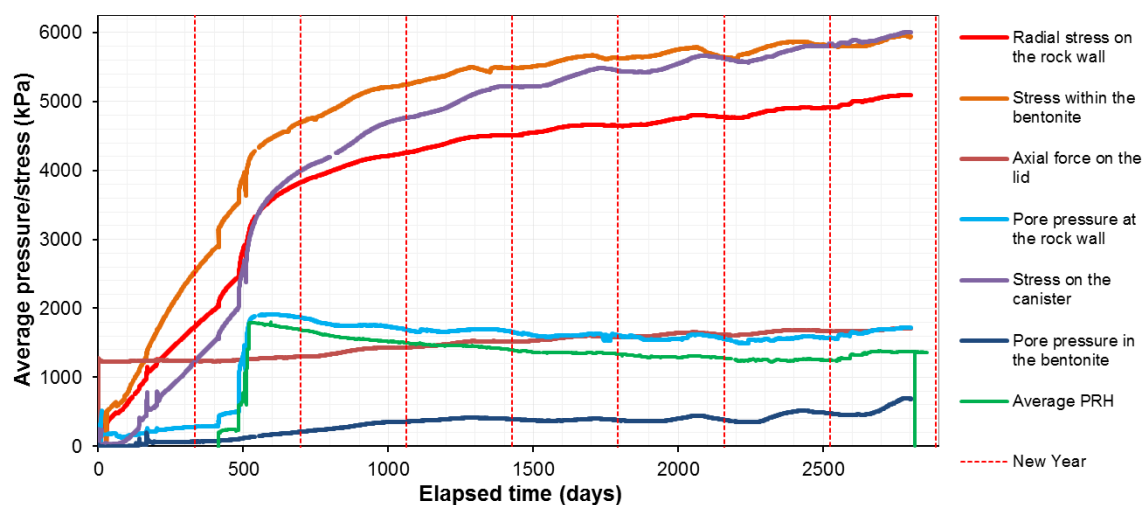

Figure 4-1 – The evolution of pressure and stress within Lasgit over the complete life-time of the experiment.

Porewater pressure monitored at the rock wall [UR] greatly increased in response to the commissioning of the packers (see Figure 4-1). Since this time, porewater pressure has slowly decayed due to the draw-down of the Äspö tunnel and range between 880 – 2,850 kPa. The long-term reduction of porewater pressure pre-dates Lasgit and is likely to be due to the construction of the Äspö HRL. Certain locations on the deposition wall have seen episodes of increased porewater pressure as fractures in the deposition hole wall have undergone episodic flow. Monitored porewater pressures within the bentonite [UB] have increased during the test in a complex manner, but remain relatively low at 300 – 520 kPa.

Radial stresses at the deposition wall [PR] have significantly increased during the experiment and now range between 2,300 kPa and 6,500 kPa. Axial stress on the canister [PC901] continues

to increase, whereas radial stress [PC902/903] has generally reached a plateau. Stress measured on the canister ranges between 5,400 and 6,500 kPa.

Stress within the bentonite, axial stress on the rockwall, and stress on the canister have almost levelled at between 5 to 6 MPa. The current rate of change of stress is approximately $0.35 \text{ kPa.day}^{-1}$ ($\sim 130 \text{ kPa.a}^{-1}$), which indicates that within the lifetime of the Lasgit experiment stress will only rise a further 1 MPa at most. As stresses within the system continue to rise, pore pressure is slowly reducing at a rate of approximately 0.1 kPa.day^{-1} ($\sim 40 \text{ kPa.a}^{-1}$) possibly due to tunnel draw-down, although this may have stabilised and started to increase. Pore pressure within the bentonite continues to remain low.

Throughout the history of Lasgit there have been a number of events that have given ‘snapshots’ of the hydraulic properties of the buffer. These include two-stage constant head tests conducted before and after each of the three gas-injection tests (see Figure 4-2a for repeat testing of filter FL903) and the shut-in (pressure decay response) of various filters; be this a scheduled activity related to gas testing or twice due to the unscheduled shut in of the system when the compressor and logging computer failed. The change in permeability and storage calculated for each of these events (Figure 4-2b/c) show that the buffer continues to ‘mature’ and is yet to reach hydraulic equilibrium. Although permeability appears to have stabilised around $6.0 \times 10^{-21} \text{ m}^2$, this value is greater than the laboratory derived permeability ($4.7 \times 10^{-21} \text{ m}^2$). This might be explained by the low density zone created next to the canister as the buffer swelled to close the 1 cm engineering gap. Greatest progress in hydration of the clay has been made near to the large filter mats above the canister, whilst the least progress has occurred just below the canister. Suction has decreased throughout the experiment confirming on-going hydration of the clay.

Clear seasonal variations (with periods of one year) have been observed in many of the instrument outputs recorded within Lasgit (see Figure 4-1) when data are viewed over the entire 2,800+ day (7.9 year) history. The clearest variation is seen in the HRL temperature. However, porewater pressure within the bentonite [UB], porewater pressure at the wall rock [UR], radial stress [PR] and the radial & axial stresses on the canister [PC] also show seasonal variability. Much of the seasonal variation shows amplitude attenuation and phase shift (time lag) with depth down the deposition hole. Some stresses within the deposition hole have increased due to buffer swelling, porewater pressures have decreased due to drawdown of the tunnel and seasonal variation has been observed due to the ventilation of the tunnel. This has resulted in a complex dynamic boundary condition that continues to slowly evolve.

It is clear that the pressure/stress regime within Lasgit continues to evolve as the buffer system matures. Whilst modelling of the saturation states estimates that the system is fully saturated, it is clear that hydraulic disequilibrium still persists. Stresses within the system are continuing to increase at a slow rate, but it would appear that the high stresses seen within the laboratory are unlikely to be attained within Lasgit. This may result from the swelling of the buffer to fill the engineering voids, this may result in a lower swelling pressure being generated. The anisotropic stress field generated within Lasgit also appears to persist. This suggests that if this feature is created by differential swelling, homogenisation of water content within the buffer is difficult to achieve. However, as Lasgit runs for longer periods the experiments continues to become more representative of the buffer system at the time of a potential canister breach.

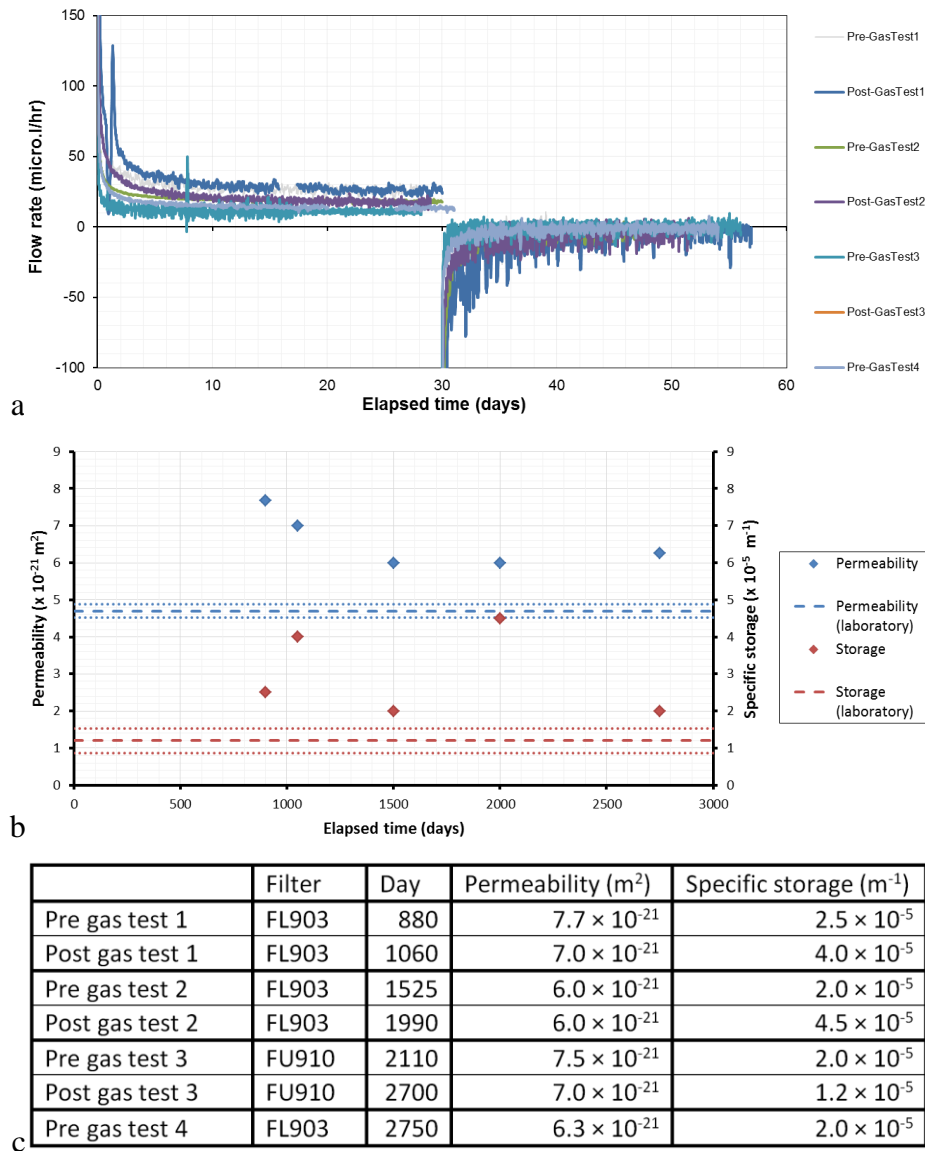

Figure 4-2 – The evolution of permeability within Lasgit over the complete life-time of the experiment. Several two-stage constant head tests (a) have been conducted. From these permeability and specific storage can be estimated (b/c).

5 Conclusions

The Large scale gas injection test, by the end of the FORGE project, had been in continuous operation for 2890 days (7.9 years) at the Äspö Hard Rock Laboratory. During this time the bentonite buffer has been artificially hydrated and has given new insight into the evolution of the buffer.

Three gas injection tests have been conducted during the duration of Lasgit showing the changes in response to gas propagation as the buffer matures. The first two tests were conducted in the lower array of injection filters at FL903. Both of these tests showed similar behaviour with a well-defined pressure peak; spontaneous negative transient; evidence of dynamic behaviour and unstable gas pathways; asymptote close to stress. The results were remarkably qualitatively similar to the laboratory test results. However, the high gas entry pressures seen in the laboratory were not seen in Lasgit as stress state is much lower due to non-complete hydration of the buffer and the expansion of the buffer to fill construction voids. The third gas test was conducted in an upper array filter (FU910). The response at the time of gas peak pressure was subtly dissimilar to that seen at FL903 with two peak pressures.

Lasgit has confirmed the coupling between gas, stress and pore-water pressure for flow before and after major gas entry at the field scale. All observations suggest mechanisms of pathway propagation and dilatancy predominate. In all three gas tests the propagation was through localised features and the general movement direction was towards the bottom of the deposition hole in the direction of the prevailing stress gradient. The injection tests have shown that the interface between barriers is a key part of the system. Gas appears to have exited the deposition hole in Gas test 2, but failed to find a way out during Gas test 3; where gas continued to migrate along the canister/buffer interface.

Throughout the history of Lasgit parts of the system have been artificially and naturally hydrated. Hydraulic results, from controlled and uncontrolled events, show that the buffer continues to mature and has yet to reach full maturation. Hydration of the clay is progressing well but sections of bentonite remain in suction and in hydraulic disequilibrium.

References

British Geological Survey holds most of the references listed below, and copies may be obtained via the library service subject to copyright legislation (contact libuser@bgs.ac.uk for details). The library catalogue is available at: <http://geolib.bgs.ac.uk>.

Aziz, K. and Settari, A. (1979) *Petroleum Simulation*. Applied Science, London

Cuss, R.J., Harrington, J.F., and Noy, D.J. (2010) Large scale gas injection test (Lasgit) performed at the Äspö Hard Rock Laboratory. Summary report 2008. Svensk Kärnbränslehantering AB (SKB) Technical Report **TR-10-38**, SKB, Stockholm, Sweden. Pp.109.

De Marsily, G. (1986) *Quantitative hydrogeology for engineers*. Academic Press, New York (440p).

Harrington, J.F. and Horseman, S.T. (1999) Gas transport properties of clays and mudrocks. In: *Muds And Mudstones: Physical And Fluid Flow Properties* (eds A.C.Aplin, A.J. Fleet, and J.H.S. Macquaker). *Geological Society of London*, Special Publication No. **158**, 107-124.

Harrington, J.F. and Horseman, S.T. (2003) Gas migration in KBS-3 buffer bentonite: Sensitivity of test parameters to experimental boundary conditions. Report **TR-03-02**. Svensk Kärnbränslehantering AB (SKB), Stockholm, Sweden.

Horseman, S.T. (1996) Generation and migration of repository gases: Some key considerations in radioactive waste disposal. In: *Proc. Int. 2-Day Conference, London, 21-22 Nov. 1996*, IBC Technical Services, Energy Division, 26 pp.

Horseman, S.T., Harrington, J.F. and Sellin, P. (1997) Gas Migration In Mx80 Buffer Bentonite. In: *Proc. Scientific Basis For Nuclear Waste Management XX*, Boston, 2-6 Dec., 1996 (eds W.J. Gray And I.R. Triay), MRS Symposia Proceedings, Vol. 465, Materials Research Society, Warrendale, Pennsylvania, 1003-1010.

Horseman, S.T., Harrington, J.F. and Sellin, P. (1999) Gas migration in clay barriers. *Engineering Geology*, **54**, 139-149.

Horseman, S.T., Harrington, J.F. and Sellin, P. (2004) Water and gas flow in Mx80 bentonite buffer clay. In: *Symposium on the Scientific Basis for Nuclear Waste Management XXVII (Kalmar)*, *Materials Research Society*, **807**. 715-720.

Sellin, P. and Harrington, J.F. (2006) Large-Scale Gas Injection Test (Lasgit) Current Status. American Nuclear Society High Level Waste Meeting, Las Vegas.

SKB (2009) Design premises for a KBS-3V repository based on results from the safety assessment SR-Can and some subsequent analyses. *SKB Technical Report TR-09-22*. Svensk Kärnbränslehantering AB (SKB), Stockholm, Sweden.